

# 2014 ASEE Zone IV CONFERENCE PROCEEDINGS

Student Success

Developing Diverse  
Engineers for a Changing  
World through Engineering

**April 24 – 26, 2014 | Long Beach, California**

ASEE Zone IV: Pacific Northwest, Pacific Southwest, and Rocky Mountain

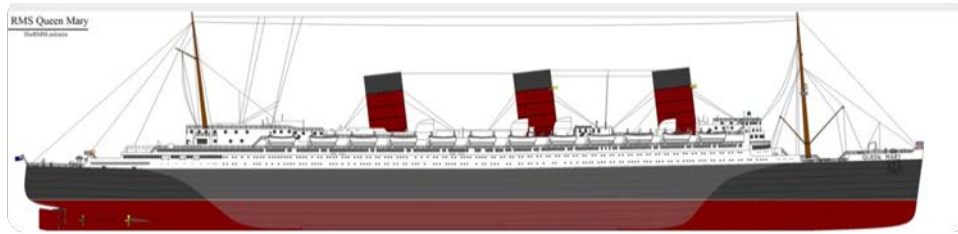

Organization website: [www.asee.org](http://www.asee.org)

Conference website: [www.csulb.edu/coe/2014-asee-zoneiv](http://www.csulb.edu/coe/2014-asee-zoneiv)

Host Institution website: [www.csulb.edu/coe](http://www.csulb.edu/coe)

#### Editors

*Lily Gossage (California State Polytechnic University, Pomona)*

*Panadda Marayong (California State University, Long Beach)*

*Marilyn Dyrud (Oregon Institute of Technology)*

## A Note from the Conference Co-Chairs

The 2014 American Society for Engineering Education Zone IV Conference—was hosted by the College of Engineering/California State University, Long Beach. Promoting the theme, "Student Success Is Our Success," it provided an excellent opportunity where faculty/professional staff presented and shared innovative tools, pedagogies, and best practices for addressing the challenges of engineering education. Particular emphasis was on student outreach, recruitment, retention, and strategies that aim to increase graduation rates and reduce achievement gaps for women, under-represented minority students, and students from under-resourced communities.

**About ASEE Zone IV:** Founded in 1893, ASEE is a non-profit multidisciplinary organization that promotes excellence in instruction, research, public service, and practice to further engineering and technology education. Zone IV, the largest of ASEE's regional groups, includes three sections: Pacific Southwest (Arizona, California, Hawaii, and Nevada), Pacific Northwest (Alaska, Idaho, Montana, Oregon, Washington, and Canada-Alberta, British Columbia and Saskatchewan), and Rocky Mountain (Colorado, South Dakota, Utah, and Wyoming).

**Program Overview:** The program included: keynote speeches from engineering educational leaders, paper sessions, workshops, a poster showcase, a forum with industry and educational leaders, and an operational tour of Boeing's famous C17 military transport aircraft. The highlight of the conference includes an awards banquet aboard the historic Queen Mary luxury liner.

We are at a critical crossroads in engineering education within the United States. With decline of American advantages in the engineering/technology marketplace, the national need for engineers is more critical than ever. Such a need has been widely articulated in numerous publications including, "Rising Above the Gathering Storm" (a report by the National Academies). We encourage participation of educators and paraprofessionals from universities, community colleges, K-12 schools, industry/corporate partners, and college students. Conferences such as this ensure that we will have an engineering workforce that is both competent as it is diverse. Thank you for advocating for engineering education!



**Lily Gossage**

2014 ASEE Zone IV Conference Co-Chair  
Director, Maximizing Engineering Potential  
California State Polytechnic University, Pomona



**Panadda ("Nim") Marayong**

2014 ASEE Zone IV Conference Co-Chair  
Associate Professor, Mechanical & Aerospace Engineering  
California State University, Long Beach

## ASEE Zone IV Conference Leadership

### Pacific Northwest, Pacific Southwest, and Rocky Mountain

#### Pacific Southwest



**Reza Raehsi, Ph.D.** (Professor/Graduate Program Coordinator, Department of Electrical & Computer Engineering/ California State University, Fresno). Raehsi has been serving as the Graduate Program Coordinator for the ECE department since 2008. His research interests include integrated circuits, embedded systems, VLSI testing and VLSI-CAD technology. He is currently serving as the 2013-2014 Chair of the American Society of Engineering Education Pacific Southwest section. He is a Coleman Fellow and entrepreneur with over 25 years of domestic and international experiences in both industry and academia. He received an M.S. and Ph.D. in computer engineering, both from the University of Cincinnati.



**Lily Gossage, M.Ed.** (Director, Maximizing Engineering Potential, College of Engineering/ California State Polytechnic University, Pomona) Gossage provides management-level oversight for development, strategic planning, promotion, and assessment of recruitment/retention programs for women and minorities. As founder of CSULB's "Women in Engineering Outreach" program, she understands the importance of community and parental support; she developed "My Daughter is an Engineer," as a residential program for 5<sup>th</sup> grade girls/parents/teachers. Recognizing that poverty often sets the trajectory for school readiness, her "Engineering Girls–It Takes A Village" residential program serves homeless girls/mothers. She serves on the Board of Directors for Women in Engineering ProActive Network and American Society for Engineering Education PSW. She is currently completing a Ph.D. in Higher Education (Walden University).



**Panadda Marayong, Ph.D.** (Associate Professor/Director of the Robotics and Interactive Systems Engineering Laboratory, Department of Mechanical & Aerospace Engineering/California State University, Long Beach) Marayong's research interests are in haptics and human-machine collaborative systems. She is a member of IEEE-Robotics and Automation Society, ASEE, SWE, Tau Beta Pi, and Phi Eta Sigma. She currently serves as the faculty advisor for CSULB's Society of Women Engineers. She is involved in many STEM educational outreach programs. Marayong received a B.S. degree in Mechanical Engineering (Florida Institute of Technology), an M.S. and Ph.D. in Mechanical Engineering (Johns Hopkins University). While at Johns Hopkins, she was part of the NSF-funded Engineering Research Center for Computer Integrated Surgical Systems and Technology and member of the Haptic Exploration Laboratory.

#### Rocky Mountain



**Nebojsa I. Jaksic, Ph.D.** (Professor/Program Director of B.S. Engineering with specialization in Mechatronics, M.S. Engineering, and M.S. Industrial and Systems Engineering programs, Department of Engineering/ Colorado State University, Pueblo) Jaksic served as ASEE Rocky Mountain Section Chair, ASEE DELOS Program Chair, ASEE DELOS Division Chair, and ASEE Zone IV Conference Program Chair; he is currently the ASEE Zone IV Chair. His interests include robotics, automation, nanotechnology, and engineering education/research. Jaksic received an M.S. in electrical engineering, an M.S. in industrial engineering, and a Ph.D. in industrial engineering all from the Ohio State University. He also received a 'Diplom Ingenieur' degree in electrical engineering (Belgrade University).

#### Pacific Northwest



**Marilyn Dyrud, Ph.D.** (Professor, Communication Studies/Oregon Institute of Technology) Dyrud has been active in ASEE for 30 years, serving in various capacities at the section, zone, and national levels, including section chair, newsletter editor, Zone IV chair, Board of Directors, and member of various national committees. She is active in the Engineering Technology & Engineering Ethics Divisions and received three Society awards: Fellow (2008), James H. McGraw Award (2010), and Frederick J. Berger Award (2013). Her research interests include engineering ethics, engineering and the Holocaust, and electronic communications media. Dyrud received a B.A. (University of the Pacific) and an M.A. and Ph.D., both from Purdue University.

## **Acknowledgments**

**We** thank the faculty, staff, and students from the hosting institution (California State University, Long Beach) and sister institution (California State Polytechnic University, Pomona), as well as the faculty/chairs and representatives from the three Zone IV sections (Pacific Northwest, Pacific Southwest, and Rocky Mountain) for volunteering their effort and time toward the planning, preparation, and organization of this conference. Special acknowledgement goes to individuals on the conference organizing committee.

### **Pitiporn Asvapathanagul**

*Civil Engineering & Construction Engineering Management/ CSU, Long Beach*

### **Marilyn Dyrud**

*Communication Studies/ Oregon Institute of Technology*

### **Forouzan Golshani**

*College of Engineering, CSU, Long Beach*

### **Jin-Lee Kim**

*Civil Engineering & Construction Engineering Management/ CSU, Long Beach*

### **Roger Lo**

*Chemical Engineering/ CSU, Long Beach*

### **Bei Lu**

*Mechanical & Aerospace Engineering/ CSU, Long Beach*

### **Reza Raeisi**

*Electrical & Computer Engineering/ CSU, Fresno*

### **Dhushy Sathianathan**

*College of Engineering/ CSU, Long Beach*

### **Praveen Shankar**

*Mechanical & Aerospace Engineering/ CSU, Long Beach*

### **Rebeka Sultana**

*Civil Engineering & Construction Engineering Management/ CSU, Long Beach*

### **Kim Truesdelle**

*College of Engineering/ CSU, Long Beach*

### **Saba Yohannes Reda**

*College of Engineering/ CSU, Long Beach*

## Table of Contents

<b>PAPERS.....</b>	<b>10</b>
High Impact Learning Practice through Group Research on Thermoelectric Energy Conversion Nanomaterials.....	11
Improving Student Learning of Basic Electric Circuits Concepts Using Current Technology.....	17
Teaching and Learning of Database Concepts Using Multimode Teaching Methodologies .....	24
Translating Best Practices for Student Engagement to Online STEAM Courses .....	32
Teaching Pattern Recognition: A Multidisciplinary Experience.....	44
Research and Projects-Based Courses to Validate Practical Engineering Solution Techniques.....	53
Student Learning and Engagement through First Year Programs.....	61
The Study of Gyroscopic Motion through Inquiry-Based Learning Activities.....	69
Cyber Education Motivated the Creation of the Virtual Instruction Cloud CLaaS, a New Distance Learning Modality.....	81
Learning by Doing, a Method to Engage Underrepresented Minority Students Learning Electrical Circuits .....	91
Electronic Laboratory Notebooks versus Paper Laboratory Notebooks: A Comparison of Undergraduate Experimental Engineering Laboratory Submissions .....	96
Laboratory Enhanced Education in Biotransport Phenomena through COMSOL Multiphysics.....	108
Student Project: Demonstration of Production of Necessary Gases for Return from and Survival on Mars – Automated Methane, Oxygen, and Hydrogen Production Using a Solar Powered Electrolysis Tank and a Table Top Sabatier Reactor .....	118
HSI STEM: Research Opportunities to Improve Retention and Increase the Pipeline to Graduate School.....	140
First-year Experience for Engineering Lab Course: The Mini-Rose Parade Float Project Update – Year 6.....	154
A Brainwriting Exercise on Improving Engineering Programs .....	159
Lessons Learned from Advanced Information Technologies on Jobsite for Construction Education.....	166
Increasing the Success of Lower Division Undergraduate Students through the Use of Common Teaching Tools .....	173
Integration of State-of-the-Art Low Cost Components into Embedded and Digital Systems Design Courses.....	182
Hands, Mind and Hearts-on Design Experiences.....	194

Insights on Integrating the Teacher-Scholar Model into the Tenure and Promotion Processes at a Teaching-Focused Engineering College .....	214
Undergraduate Courses to Professional Engineering Design: A Disconnected Trajectory? .....	228
Student Engagement, Learning, and Retention in a Freshman, Large Class Setting at the University of Arizona .....	240
Machine Vision, PLCs and Motion Control for Manufacturing Engineering Undergraduate Students .....	247
Research and Practice Group Methodology: A Case Study in Student Success.....	255
The Design and Construction of a Tiny House: Small Is Beautiful.....	268
An Outline for a Practical Course in Computer-Aided Design and Analysis in Civil Engineering.....	283
A Service-Learning Collaborative Project in a Mechanical Engineering Technical Writing Class.....	289
Increasing Diversity in Technical Education: The Importance of Building Technical Capital .....	294
Assessment of Team Projects in an Electrical Power Systems Course.....	305
Experience from a Faculty Exchange Program: Student Success Lessons from Cal Poly State University.....	309
Microhydro for Rural Electrification as a Learn-By-Doing and Multidisciplinary Project: Lessons Learned .....	314
Student Success in Introductory Physics .....	321
Linking Theory with Experiential Learning in Virtual Learning Environment .....	326
Preparing Community College Students for Civil Engineering Profession through Design and Evaluation of a Three-Story Steel Plate Shear Wall.....	333
Agile Development Using Cloud IaaS and PaaS in Computer Science Curricula.....	340
Evaluation of Modal Analysis for Time-Delayed Multi-Degree of Freedom Structures for Reliability Assessment of Real-Time Hybrid Simulation Results.....	350
An Assessment of ABET's Assessment Process.....	359
Computer Application Blended Course Redesign: Lessons Learned and Impact on Student Success .....	363
A Graduate/Senior Level Interdisciplinary Medical Technology Design Class.....	374
High-Efficiency Inverted Instruction: Doubling Capacity while Preserving Small Classroom Quality .....	382
Application of Project-Based Learning (PBL) Method in a Senior Year Engineering Design Course .....	388
Leveraging Scholarships to Advance Student Success .....	413
Reliability Assessment Analysis for Real Time Hybrid Simulation with Fluid Viscous Dampers .....	422

Combination of Shake Table Experiments and Computer Simulation to Enhance Structural Engineering Curriculum in Earthquake Engineering .....	429
Carbon Nanotube Composites: Using an Authentic Engineering Research Problem to Engage Middle School Students in STEM.....	443
Crossing the Bridge: ABET Accreditation.....	456
Green Energy Conference Experience – Integration of Class Room Research Projects to IEEE Professional Presentation.....	465
LEGO Mindstorms: EV3 versus NXT 2.0 A Laboratory Study in an Introduction to Engineering Course .....	486
Initiatives to Improve Student Success and Retention in The Lyles College of Engineering California State University, Fresno.....	492
<b>POSTER ABSTRACTS</b> .....	518
Teaching HVAC/R in a Learn by Doing Mechanical Engineering Program Using Industrial Training Equipment.....	519
Student Engagement in STEM Careers Early on through Engineering Clubs at a Middle & High School: Teacher Practices from the Trenches.....	519
Cause of <i>Gordonia amarae</i> -like Foaming in an Incompletely Nitrifying Plant: 3.5 Year Study .....	520
Multidisciplinary Robotic Arm Project.....	521
Solar Powered Alternator .....	521
Improving Student Success in General Chemistry at CSULB .....	522
Optimizing a Wirelessly Powered AC-DC Boost Converter for Biomedical Implants.....	522
National Science Foundation S-STEM Scholarships: Recruitment and Cohort Establishment for Engineering and Computer Science Students.....	523
Dynamic Plant Development for Control Systems and Mechatronics Experiments.....	524
“Engineering Girls – It Takes A Village”: Serving Homeless Middle School Girls via a K-12 Engineering Summer Residential Program .....	524
Stereotype Threat and Social Identity Concerns of African-American, Female Engineering Students: A Grounded Theory Investigation .....	525
Green Energy Project: Gravity Light.....	525
Four-Semester Evaluation of Placing Underclassmen in a Senior Level Course as a Retention Strategy .....	526
Anticipating Student Success by Means of a Simple Math Quiz .....	526
Gyroscopic Cup Holder .....	527
Exposing Students to State-of-the-Art in Unmanned Vehicles Technologie.....	528
Design and Testing of an Engaging Submersible Robot for Remote Exploration of the Cabrillo Marine Aquarium and Surrounding Marine Environment.....	528

Specification of Performance Criteria for Assessment of Student Outcomes.....	529
Teaching Digital Signal Processing through Music .....	529
Expanding Multi-institutional Bonds to Team up Students for the Creation of Research Environmental Projects .....	530
Augmented Reality for Visualization and Feature Identification of Solid Models in Engineering Graphics .....	531
Modeling and Implementation of Brain-Inspired Neural Network for Edge Detection and Object Recognition.....	531
An Organizational Model to Manage the Assessment Process for ABET .....	532
The Integration of the <i>Promotores</i> Model and the Cultural Capital Model to Catalyze Latino Educational Success in Engineering.....	532
ENGR102 Project: Assisting Freshmen Engineering Students to Validate their Choice of Major or Consider Other Options Based on their Interests and Abilities .....	533
Utilizing Steel Plate Shear Walls for Seismic Hazard Mitigation .....	534
Using the SELECT Format in an Introductory Engineering Course.....	534
Using Inquiry Based Learning Activities to Teach Dynamics .....	535
Using Algorithms to Enhance Comprehension of Concepts in Introductory Chemistry Courses.....	535
Effect of Climate Change on the Critical Elevation Zones in a Snow Dominated Mountainous Watershed in the Sierra Nevada, CA.....	536
Modeling Civil Engineering Practice in Student Activities.....	537
Integrating STEM into K-6 Teacher Education: A Multi-Disciplinary Approach to Faculty Collaboration.....	537
Drones for Personal and Commercial Use: Implementing a New Design with Zero Emissions.....	538
Inspiring the Next Generation of Female Scientists and Engineers .....	539
Using Videos to Enhance Engineering Instruction.....	539
Faculty Participation in a Learning Community Improves STEM Student Success.....	540
Training Mathletes Using Countdown Method.....	540
<b>WORKSHOP ABSTRACTS</b> .....	542
“Jack of All Trades, Master of None” – The Challenge for Future Oriented, Interdisciplinary Curriculum Programs.....	543
Teaching Engineering Ethics: A Basic Strategy .....	544
New Potential in Presenting Research in the Engineering Literature: Opportunities for Scholarship and Instruction through Video .....	544
A Difficult Topic Made Easy: Developing A Straightforward Tuning Method for Acid Neutralization Control System .....	545
Internet-Based System for Undergraduate Process Control Lab.....	546



Integrative Method for Teaching Undergraduate Mechatronics Course by Combining Virtual and Hardware-in-the-Loop Simulations.....	547
Sustainability Systems Simulation for Engineers and Non-Engineers.....	548
IEEE Xplore: What's In It for You?.....	548
Culturally Relevant Pedagogy in Science and Engineering: Theory into Practice.....	549
Hands-on Gadgets to Facilitate Algorithmic Thinking and Problem Solving .....	550
Beyond the Basics: Transforming Engineering Education .....	550
MESA WORKS: Inspiring Young Minds to Become Future Mathematicians, Engineers and Scientists by Incorporating Common Core State Standards .....	551
<b>AUTHOR INDEX</b> .....	552



**April 24 - 26, 2014 | Long Beach, California**  
ASEE Zone IV: Pacific Northwest, Pacific Southwest, and Rocky Mountain

# PAPERS

## High Impact Learning Practice through Group Research on Thermoelectric Energy Conversion Nanomaterials

Matthew Adle, Justin Bostwick, Kyle Graves, Synjin Hipolito, and Yong Gan  
California State Polytechnic University, Pomona

### Abstract

High impact learning practice refers to enhancing students' learning through senior capstone design and undergraduate research. A faculty-student team in Department of Mechanical Engineering, College of Engineering, California State Polytechnic University, Pomona formed and performed research in the Senior Capstone Design course. The work deals with manufacturing multicomponent organic/inorganic composite materials containing nanotubes, nanofibers and nanoparticles in electric field. One of the fundamental problems associated with the manufacturing process is how fast the thermoelectric nanoparticles move into the titanium dioxide nanotubes under the electric force. The results were used to examine the effect of the manufacturing parameters on the production rate and the uniformity of the composite materials made in the casting process. The specialty of the project lies in the hands-on learning strategy for training upper level undergraduate students in the emerging field of energy conversion. Some special learning methods such as active learning via student interactions, instructor-student face to face learning were adopted in the classroom activities. It is concluded that the active learning should be the future trend in educating upper level students. The curriculum we should strive for is an integration of knowledge learning and hands-on practicing. Through such a particular project, students should be better trained for energy manufacturing industry.

### Introduction

Semiconducting polymers have been extensively studied due to their unique properties and advantages over other ceramics semiconducting materials such as light weight and easy to processing<sup>1,2</sup>. Polyaniline (PANi) is a typical semiconducting polymer with a conjugated structure. It has excellent stability in air. Polyaniline is stable at elevated temperatures. It has been used for sensors, batteries, super capacitors, etc. It is also considered for thermoelectric energy conversion<sup>3</sup>. There has been an increasing in research on polyaniline since its conductivity could be changed over ten orders of magnitude by doping<sup>4</sup>.

Nanocasting has the capability of generating well-ordered, very fine entities such as nanofibers or nanorods, coaxial nanotubes, and porous architectures. Traditional casting refers to the solidification process whereby a molten metal is transferred into the cavity of a mold<sup>5</sup>. Casting is considered as a cost-effective technique for manufacturing various parts<sup>6</sup>. Casting can be combined with rolling, which is the semisolid casting. The molten metal is cast into a large ingot. The ingot is subjected to a hot-rolling process. In some cases, the molten metal is cast into the space of water cooled dies so that the metal is in a mixed liquid and solid state. The semisolid slurry is under the subsequent extrusion or rolling, thus, segregation is inhibited. Chemical composition and mechanical properties are more uniform<sup>7</sup>. Inspired by the casting technique, researchers have considered making nanoscale components or features using the similar process. This is the origin of nanocasting technology. Nanocasting deals mainly with nonmetallic material processing. For example, oligomeric surfactants and block copolymers have been used to cast nanoporous materials<sup>8,9,10,11,12</sup>. Porous silica materials were obtained via nanocasting on a pseudopolyrotaxanes template synthesized from  $\alpha$ -cyclodextrin and polyamines<sup>13</sup>. Nanocasting two-

dimensionally (2D) ordered porous arrays using monolayer colloidal crystal templates has the advantage of generating hierarchical structures at micro and nanometer length scales. Polystyrene (PS) beads with the size of 1 micron were used to form 2D ordered arrays<sup>14</sup>. The arrays were served as the casting molds to make Co<sub>3</sub>O<sub>4</sub> hierarchical structures.

The external force-assisted nanocasting or spinning concept has been proposed for years<sup>15,16,17,18</sup>. This technique has been studied for making polymer fibers<sup>15,17,19</sup>. The principles have also been explored for manufacturing ceramic fibers<sup>15,18</sup>. By extending the external force-assisted nanocasting process concept to various material systems, it is possible to synthesize fibers as suitable organic-inorganic composites. Up to now, there is very limited research work done on electric force assisted centrifugal nanocasting thermoelectric composite materials. The challenges of this new technology include: the use of a single step process to manufacture large scale fiber reinforced materials; increasing the production rate of the nanostructures while keeping the cost associated with the manufacturing process reasonable; and most importantly, to manufacture heterogeneous material-supported composites with controlled architectures for thermoelectric energy conversion. It is important to understand the fundamentals of electric force assisted nanocasting manufacturing process and to use this new approach to make organic- inorganic composites.

Cooperative learning of scalable and low cost manufacturing process for making high performance nanomaterials has caught big attention. One of the education activities in California State Polytechnic University, Pomona is to develop workforce for energy manufacturing. A fast, scalable and low cost manufacturing process for making high performance thermoelectric energy conversion composite materials emerges as one of the challenge problems to be tackled. Specifically, the focus is on developing a physics-based predictive model for coupled electromagnetic and mechanical forces in centrifugal casting thermoelectric nanoparticle- containing semiconducting polymers with a newly designed rotary machine and conducting experiments to verify the model, testing the hypothesis that incorporating nanoscale thermoelectric components into polymers to form complex composite structures significantly enhances the energy conversion performance, evaluating the feasibility of using electromagnetic force assisted centrifugal casting to make thermoelectric energy conversion nanomaterials containing multilayer polymer/oxide nanotubes, establishing the relationship between the energy conversion behavior and manufacturing conditions. Such manufacturing related activities provide knowledge and understanding to meet the critical need of energy challenge for the nation. A globally competitive energy manufacturing industry will contribute to the nation's economy. Thermoelectric units with higher energy conversion efficiency and lower manufacturing cost will benefit consumers and the society. Research results enhance undergraduate students' learning in such courses as Independent Study and Senior Capstone Design. Training undergraduate students through the cooperative learning can increase their chances to secure jobs in the field of advanced manufacturing.

### **Materials and Methods**

All the materials used in this work were purchased from Alfa Aesar. Fig. 1(a) shows the schematic of the electric force assisted nanocasting experimental set-up. A precision auto lapping/polishing machine was used as the main part. This machine contains a rotating platform whose speed can be well controlled. A Shimpo tachometer was used to measure its rotating speed. The TiO<sub>2</sub> nanotube specimen was put at the two ends of a plastic pipe being fixed on the rotating platform. High voltage of 15 kV was applied across the aniline solution. Aniline was electrochemically polymerized in the TiO<sub>2</sub> nanotubes because the titanium plates, as anodes, were connected by two carbon fiber brushes to the outer ring which serves as

the positive electrode of the DC power source. Under the combined electric and mechanical forces, the polymerized polyaniline was cast into nanofibers within the TiO<sub>2</sub> nanotubes. The centrifugal casting principle is shown in Fig. 1(b).

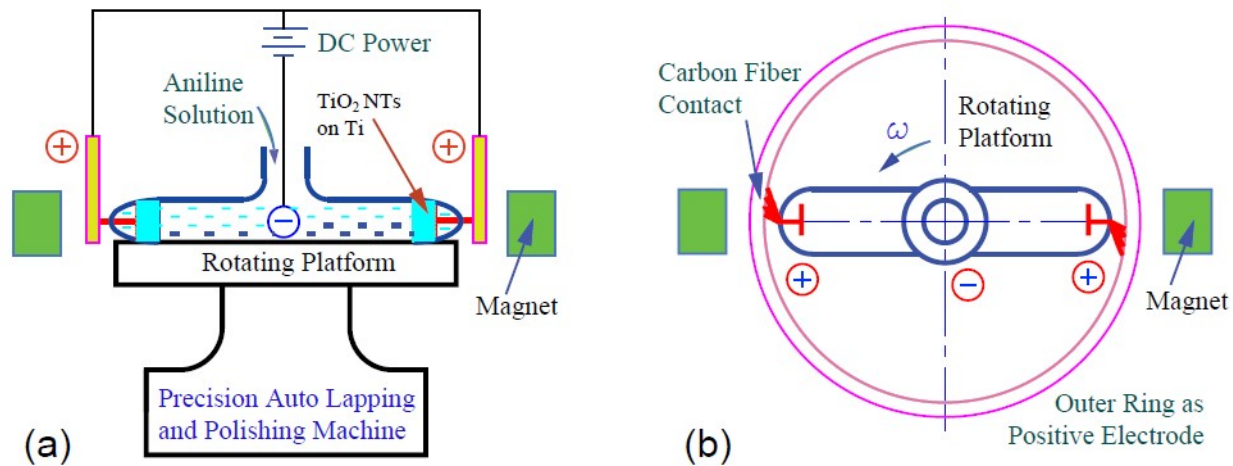

Fig. 1. Electric force assisted nanocasting experimental set-up and the working principle: (a) the rotating platform holds the nanocasting unit, (b) nanocasting under external forces.

The Seebeck coefficient of the nanofiber composite was measured using a self-build measurement system containing a Talboys heat platform with temperature control and a mode 410 Extech multimeter. The nanofiber composite was clamped onto two strips of aluminum tape for voltage measurement. The temperature difference was imposed at the two ends of the specimen. The absolute values of the Seebeck coefficients obtained at different measuring temperature ranges were obtained and plotted. The resistance of the composite material was also measured by the two point method using a CHI 600E electrochemical workstation running under the linear scanning mode.

## Results and Discussion

Without combined electric and centrifugal forces, the electrochemically polymerized polyaniline started growing just at the surface of the titanium dioxide nanotubes as revealed by both the scanning electron microscopic (SEM) image of Fig. 2(a) and the transmission electron microscopic (TEM) image of Fig. 2(b). Because the aniline solution is hydrophobic, it tends to stay on the top surface of the titania nanotubes which are hydrophilic. Therefore, electrocentrifugal nanocasting has to be used to draw the aniline into the nanotubes under coupled electric and mechanical forces. The thermoelectric nanoparticles were made by the Galvanic displacement method similar to that as reported in<sup>20,21,22</sup>. In previous work<sup>20,21</sup>, Ni-Fe alloy was used as the raw material. But in this work, Ni and Co nanoparticles were used as the precursors to form core shell particles due to the better controllability. The surface layer was BiTe alloy and the core was Ni or Co. BiTe alloy is used because it is considered as one of the best materials with high value of Seebeck coefficient in a wide temperature range. Since Ni or Co tends to be attracted by magnetic force, the BiTe/Ni shell-core nanoparticle clusters (as shown in Fig. 3a) in the aniline solution held by the plastic container (as shown in Fig. 3b) move outwardly towards the TiO<sub>2</sub> nanotubes. The size of the nanoparticles, 4 nm, as seen from Fig. 3(a), is much smaller than the inner diameter of the nanotubes, which is about 120 nm as can be seen from Fig. 3(c). Obviously, the external field helped the thermoelectric nanoparticles go into the nanotubes.

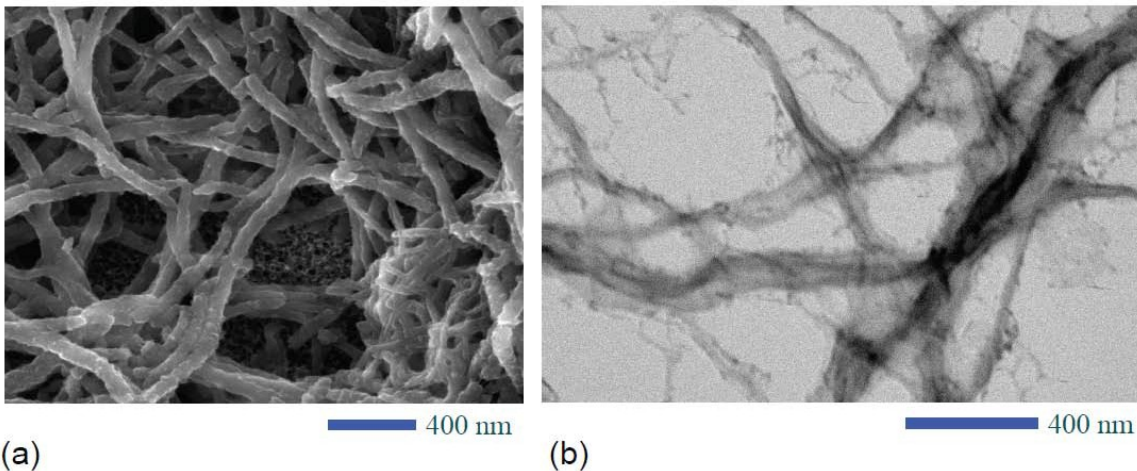

Fig. 2. Images of polyaniline nanofibers on titanium dioxide nanotubes: (a) SEM and (b) TEM.

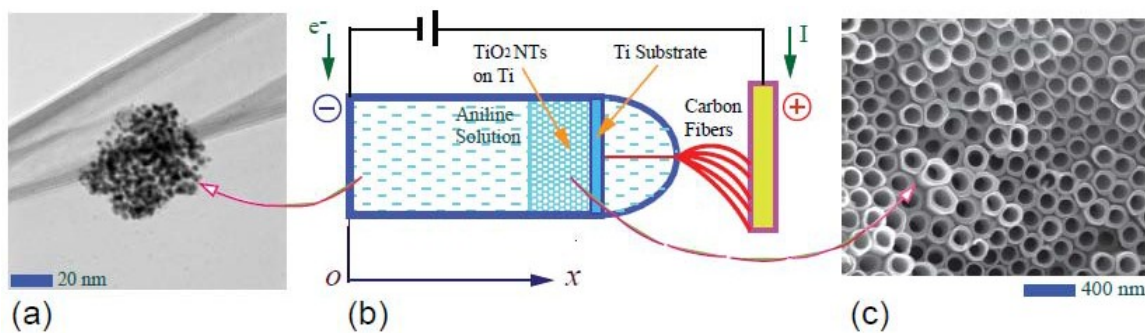

Fig. 3. (a) TEM image of a BiTe/Ni shell-core nanoparticle cluster generated by Galvanic displacement, (b) BiTe/Ni in aniline solution (c) SEM image of titanium dioxide nanotubes.

It is found that the stable Seebeck value for the polyaniline nanofiber is about  $20 \mu\text{V/K}$  as shown in Fig. 4. The material shows  $n$ -type behavior. As compared with the inorganic semiconducting material, bulky silicon crystalline material, the nanofiber has lower value of Seebeck coefficient. The measured Seebeck value of the silicon bulk material is as high as  $40 \mu\text{V/K}$  under the same measurement conditions. Therefore, further improvement on the thermoelectric property of the polymeric nanomaterial is needed. The electrical resistance of the nanocast polyaniline nanofiber was measured at the room temperature of  $25^\circ\text{C}$ . The material shows the resistance of  $35 \text{ M}\Omega$ , which is in the range of those typical semiconducting materials.

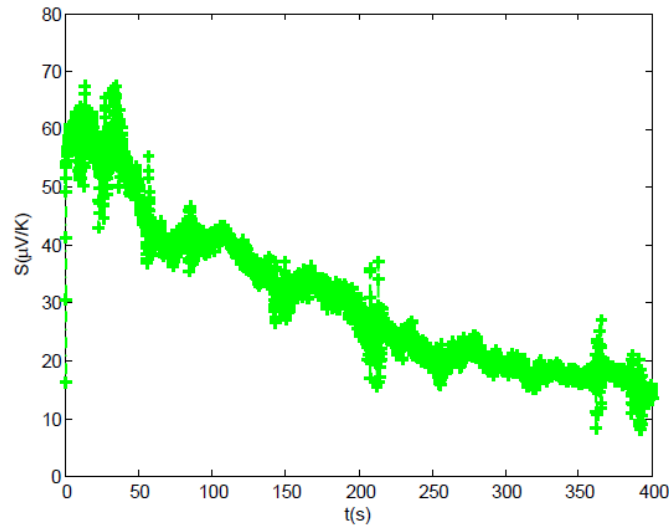

Fig. 4. Seebeck coefficient of the polyaniline material measured at room temperature

### Conclusions

Polymer based composite nanomaterial can be processed under the assistance of high electric field. The nanocomposite shows  $n$ -type property with an average Seebeck value of  $-20 \mu\text{V/K}$ . The electrical resistance of the composite is about  $35 \text{ M}\Omega$ . The preliminary results from this work show the promising of the electric force assisted nanocasting. Future work will be on developing a commercially viable, scalable manufacturing process ensuring high process yield, process and product repeatability and reproducibility, along with optimized quality control. The scalable manufacturing process should be further tested for producing functional nanocomposites for high efficiency thermoelectric energy conversion. Some special learning methods such as active learning via student interactions, instructor-student face to face learning are effective. Cooperative learning should be emphasized on educating upper level students. The curriculum we should strive for should integrate knowledge learning and hands-on practicing.

### Acknowledgments

This work is supported by the US National Science Foundation (NSF) under Grant No. CMMI-1333044. We also acknowledge the support from Chancellor's Office, California State University through the Campus-as-a living-lab program.

### Bibliography

1. Cumbal, L.; Greenleaf, J.; Leun, D.; SenGupta, A.K., Polymer supported inorganic nanoparticles: characterization and environmental applications, *Reactive & Functional Polymers*, 2003,54, 167–180.
2. Ma, J. ; Yang, Z. ; Wang, X. ; Qu, X. ; Liu, J. ; Lu, Y. ; Hu, Z. ; Yang, Z., Flexible bi-continuous mesostructured inorganic/polymer composite membranes. *Polymer*, 2007, 48, 4305- 4310.
3. Su, L.; Gan, Y.X., Experimental study on synthesizing  $\text{TiO}_2$  nanotube/polyaniline (PANI) nanocomposites and their thermoelectric and photosensitive property characterization. *Composites Part B: Engineering*, 2012, 43, 170-182.
4. Chiang, J. C. ; Macdiarmid, A. G., Protonic acid doping of the emeraldine form to the metallic regime, *Synthetic Metals*, 1986, 13, 193.
5. Shackelford, J.F., *Introduction to Materials Science for Engineers*, 2005, Pearson Prentice Hall, Upper Saddle River, New Jersey, p.423.
6. Callister, W.D., *Materials Science and Engineering: An Introduction*, 2003, John Wiley & Sons, New York, p.355.
7. Gan, Y.X.; Overfelt, R.A., Fatigue property of semisolid A357 aluminum alloy under different heat treatment conditions, *J. Mater. Sci.* 2006, 43, 7537–7544.

8. Attard, G.S.; Glyde, J.C.; Goltner, C.G., Liquid-crystalline phases as templates for the synthesis of mesoporous silica, *Nature*, 1995, 378, 366–368.
9. Goltner, C.G.; Antonietti, M., Mesoporous materials by templating of liquid crystalline phases, *Adv. Mater.* 1997, 9, 431–436.
10. Goltner, C.G.; Henke, S.; Weibenberger, M.C.; Antonietti, M., Mesoporous silica from lyotropic liquid crystal polymer templates, *Angew. Chem.* 1998, 110, 633–636.
11. Kramer, E.; Forster, S.; Goltner, C.; Antonietti, M., Synthesis of nanoporous silica with new pore morphologies by templating the assemblies of ionic block copolymers, *Langmuir*, 1998, 14, 2027–2031.
12. Goltner, C.G.; Berton, B.; Kramer, E.; Antonietti, M., Nanoporous silicas by casting the aggregates of amphiphilic block copolymers: The transition from cylinders to lamellae and vesicles, *Adv. Mater.* 1999, 11, 395–398.
13. Han, B.H.; Smarsly, B.; Gruber, C.; Wenz, G., Towards porous silica materials via nanocasting of stable pseudopolyrotaxanes from alpha-cyclodextrin and polyamines, *Microporous Mesoporous Mater.* 2003, 66, 127–132.
14. Xia, X.H.; Tu, J.P.; Zhang, J.; Xiang, J.Y.; Wang, X. L.; Zhao, X.B., Cobalt oxide ordered bowl-like array films prepared by electrodeposition through monolayer polystyrene sphere template and electrochromic properties, *ACS Appl. Mater. Interfaces* 2010, 2, 186–192.
15. Amalorpava Mary, L.; Senthilram, T.; Suganya, S.; Nagarajan, L.; Venugopal, J.; Ramakrishna, S.; Giri Dev, V.R., Centrifugal spun ultrafine fibrous web as a potential drug delivery vehicle, *eXPRESS Polym. Lett.* 2013, 7, 238–248.
16. Bao, N.; Wei, Z.; Ma, Z.; Liu, F.; Yin, G., Si-doped mesoporous TiO<sub>2</sub> continuous fibers: Preparation by centrifugal spinning and photocatalytic properties, *J. Hazardous Mater.* 2010, 174, 129–136.
17. Wang, L.; Shi, J.; Liu, L.; Secret, E.; Chen, Y., Fabrication of polymer fiber scaffolds by centrifugal spinning for cell culture studies, *Microelectronic Eng.* 2011, 88, 1718–1721.
18. Sedagha, A.; Taheri-Nassaj, A.; Naghizadeh, R., An alumina mat with a nano microstructure prepared by centrifugal spinning method, *J. Non-Crystalline Solids*, 2006, 352, 2818–2828.
19. Sandou, T.; Oya, A., Preparation of carbon nanotubes by centrifugal spinning of coreshell polymer particles, *Carbon*, 2005, 43, 2013–2032.
20. Suh, H.; Jung, H.; Hangarter, C.M.; Park, H.; Lee, Y.; Choa, Y.; Myung, N.V.; Hong, K., Diameter and composition modulated bismuth telluride nanowires by galvanic displacement reaction of segmented NiFe nanowires, *Electrochimica Acta*, 2012, 75, 201–207.
21. Suh, H.; Nam, K.H.; Jung, H.; Kim, C.Y.; Kim, J.G.; Kim, C.S.; Myung, N.V.; Hong, K., Tapered BiTe nanowires synthesis by galvanic displacement reaction of compositionally modulated NiFe nanowires, *Electrochimica Acta*, 2013, 90, 582–588.
22. Gan Y.X.; Koludrovich, M.J.; Zhang, L., Thermoelectric effect of silicon nanofibers capped with Bi-Te nanoparticles, *Materials Letters*, 2013, 111, 126–129.



## Improving Student Learning of Basic Electric Circuits Concepts Using Current Technology

Zekeriya Aliyazicioglu, Rajan Chandra, Phyllis Nelson, Jolly Kuo, and Shailesh Sujanani  
California State Polytechnic University, Pomona

### Abstract

This paper describes web-based supplemental materials developed at California State Polytechnic University Pomona that enable students at any time during their academic career to review and practice fundamental network analysis concepts. Students interact with these materials via a web browser, making them platform independent. The project targets improving both learning and retention by providing engaging interactive online resources, including lectures, motivated by practical real-world examples and supported by embedded self-tests. These learning materials are being used to enrich student learning in the initial networks course, but can also be accessed by students in follow-on courses to refresh their knowledge at any time. The original project focused on web-based learning materials, but is now being extended to include a variety of related tools including the web-based simulation tools CircuitLab [1] and National Instrument's myDAQ [2] measurement and instrumentation devices. Our preliminary assessment results indicate that the web-based resources improve students' learning. Also, our surveys indicate weak students benefit significantly from our short videos of problem solutions.

### Introduction

Student success in electrical engineering is built on mastery of fundamental network analysis concepts such as Kirchhoff's laws, nodal and mesh analysis, and the Thevenin and Norton theorems. However, the course in which these concepts are taught comes early in the student's post-baccalaureate career. Many students at this level have not yet understood that mastery of these concepts is essential to success in later courses. Enabling students to access these learning materials when they need them, whether during the first course or later in their academic career, helps them to become more active participants in the learning process. Development of new learning materials for basic circuit concepts began with a realization that the course covering these concepts has one of the lowest pass rates in our curriculum. The first focus was on development and assessment of web-based learning materials covering the concepts listed above. The project is now being supplemented with simulations using CircuitLab[1], an online schematic editor and circuit simulator that is free for academic use, and the low-cost National Instruments myDAQ data acquisition device[2] for experimenting with physical components and circuits. Combining the web-based curriculum materials with a circuit simulator and data acquisition device provides students the ability to do the following:

- (a) Watch online problem solving tutorials
- (b) Assess their understanding and receive feedback on their progress with self-test problems
- (c) Verify their results, as well as and investigate the effects of parameter variations and other modifications of a circuit with CircuitLab and,
- (d) Validate their results by building the circuit and testing it with the myDAQ

None of the above activities require specialized laboratory facilities, so a student can work on all phases of circuit analysis and design in their normal study environment (for example, their dormitory room). This flexibility allows students to actively explore circuit concepts and remedy deficiencies outside of the traditional classroom and laboratory. The use of the myDAQ supports a key requirement of engineering pedagogy: comparing actual measurements with the predictions of simulation and analysis.

Our suite of tools can benefit both those who are beginning their study of electrical engineering and those who need to improve their understanding of a specific concept.

### **Prime Motivating Factors and Design Strategy**

Low cost devices such as tablets and smartphones, plus the proficiency of today's students with these devices, suggested web-based technology for providing assistance to students who are currently enrolled in freshmen circuit analysis classes and those who need assistance with basic circuit concepts. The primary goal of developing cloud-based tools is to provide interactive experiences designed to serve students with a variety of learning styles.[5-7] The resource set we have developed includes lectures, example and practice problems supported by step-by-step solutions, online and hands-on circuit simulation, and YouTube videos. Five minute videos replicate the experience of a tutor sitting next to a student and solving the problem on a piece of paper. All of these learning materials are online to enrich freshman electrical engineering learning, but can also be accessed by students in follow-on courses to refresh their knowledge at any time.

Topics were identified by interviewing professors and student club members, and also by conducting in-class surveys. Based on these inputs, the following topics were selected: nodal and mesh analysis, plus Thevenin and Norton equivalent circuits. Lecture notes that provide narrative explanations are being developed. Each topic discussion begins with a relevant practical application. A minimum of four examples are available for each topic. Each example includes a detailed narrative of how to approach the problem, along with equations and figures. The goal of these examples is to teach the problem-solving process. Students can access the solutions in html, pdf, and YouTube video formats, allowing them to choose the medium that best fits their learning style and resource availability. The CircuitLab [1] schematic that is attached to each example provides both verification of the solution and the opportunity for visual and kinesthetic learners to interact more directly with the material.

Several practice problems provide students guided practice in applying each topic. These problems have been supplied by a variety of instructors, and so are representative of the teaching styles and approaches to a topic that are used in our curriculum. After working the detailed examples for each topic, students can attempt these practice problems, receiving feedback not only on their answer, but also on intermediate results. Students also have the option to see a complete hard copy solution directly or watch the video solution on YouTube.

CircuitLab is used to simulate the circuits in the examples and problems [1]. Students can also create a new problem by modifying the circuit to experiment with the sensitivity of the node voltages or branch currents to the component placements and values. A minimum of four exercise problems are provided for each topic. These problems are similar to actual final exam questions, so they test the student's ability to apply the concept in a typical context. We have only provided the final answer to each exercise problem. In the future, we may provide some multiple choice problems so that student can develop experience with this form of testing and also learn to recognize absurd or impossible choices.

The first phase of our project, developing and assessing these web-based learning resources, is now entering the assessment phase. A second phase, adding the National Instruments myDAQ measurement and instrumentation device, will begin in the spring of 2014. The myDAQ, coupled with simulations in CircuitLab, enables replication of the full circuit analysis and design process outside of the traditional classroom and laboratory. Engineering students, especially those who are visual or kinesthetic

learners, gain significant benefit from independently experimenting, gathering data.

### Typical Scenarios of Online Web-Tools in Operation

Online web tools have been created in the HTML5 format for compatibility with many different platforms and web browsers. Each example and practice problem are available in html and pdf formats. A link is provided at the end so that students can watch the solution on YouTube and/or simulate the circuit with CircuitLab. Fig. 1 shows a sample problem with its solution and the links to additional resources. CircuitLab has an in-browser schematic capture and circuit simulation software tool to help students rapidly modify and analyze circuits, as shown in Fig. 2. A video solution for each example and practice problem is available on YouTube. Our short videos encourage students to watch the entire presentation, and also allows them to stop or rewind as necessary for full comprehension. Fig. 3 shows a sample of a video session. This environment makes a student feel that the professor is solving the problem for them one-on-one. Our survey has indicated that this is the most popular format in our toolkit.

**Example 1:** Find the current through each branch.

Step 1: Select the close loop current direction  $I_1$  and  $I_2$ .

Step 2: Apply Kirchoff's voltage law to each closed loop

For first loop

$$10I_1 + 50(I_1 - I_2) + 10 - 20 = 0$$

$$60I_1 - 50I_2 = 10$$

For second loop

$$-10 + 50(I_2 - I_1) + 100I_2 = 0$$

$$-50I_1 + 150I_2 = 10$$

Step 2: Simultaneous Equation

$$\begin{bmatrix} 60 & -50 \\ -50 & 150 \end{bmatrix} \begin{bmatrix} I_1 \\ I_2 \end{bmatrix} = \begin{bmatrix} 10 \\ 10 \end{bmatrix}$$

$$I_1 = \frac{\begin{bmatrix} 20 & -50 \\ 10 & 150 \end{bmatrix}}{\begin{bmatrix} 60 & -50 \\ -50 & 150 \end{bmatrix}} = \frac{20 \times 150 - 10 \times (-50)}{60 \times 150 - (-50) \times (-50)} = 0.3077 \text{ A}$$

$$I_2 = \frac{\begin{bmatrix} 20 & -50 \\ 10 & 150 \end{bmatrix}}{\begin{bmatrix} 60 & -50 \\ -50 & 150 \end{bmatrix}} = \frac{20 \times 150 - 10 \times (-50)}{60 \times 150 - (-50) \times (-50)} = 0.169 \text{ A}$$

Figure 1. Example of problem solution and related links.

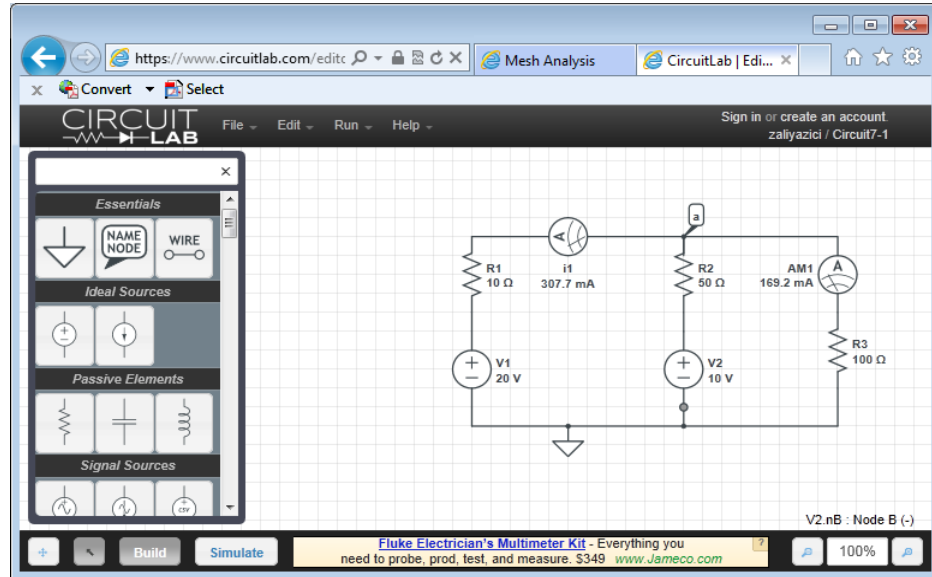

Figure 2. Example of problem solution and links.

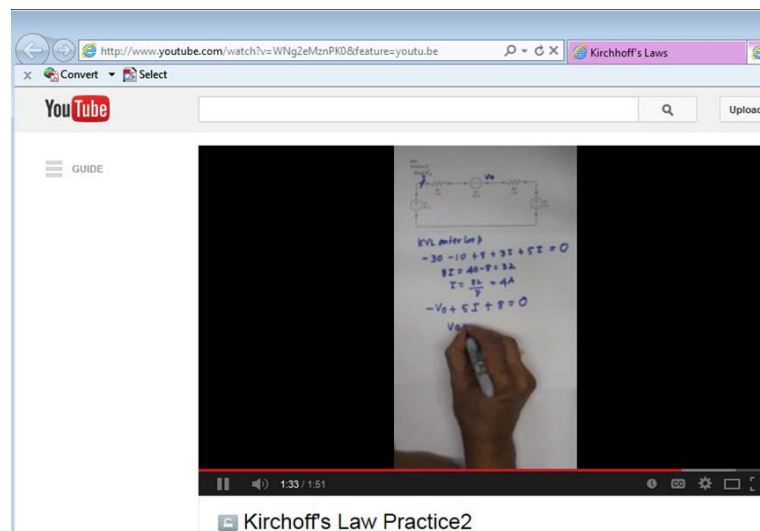

Figure 3. Video session on YouTube.

The myDAQ is an inexpensive data acquisition device that can be used in the Labview environment to provide a cluster of virtual measuring instruments. This device gives students the ability to compare the analytic solution to circuit problems with measurements of a physical implementation [3]. First, students are asked to calculate selected voltages or currents in a circuit. Then they measure the values of these voltages or currents in an actual circuit using the myDAQ. Finally, they can compare the two for any discrepancies between the calculated and measured values. This approach helps build a student's confidence by validating the results of calculation and simulation, and also develops facility with measurements and troubleshooting.

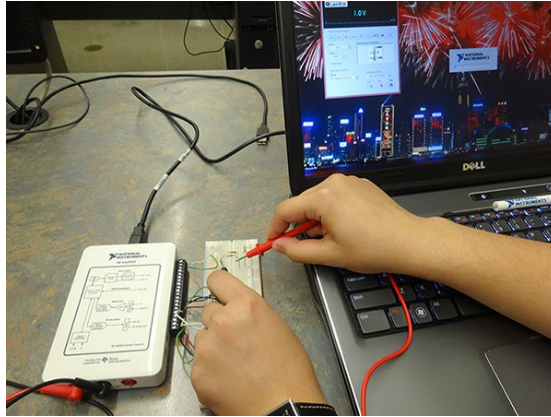

Figure 4. myDAQ experimental setup.

### Performance Assessments

We have developed surveys to obtain student feedback. The survey questions are as follows:

1. The online tutorial provided sufficient information about ECE 109 materials
2. The tutorial examples are in depth and useful
3. The tutorial helped me to better understand fundamental ideas presented in ECE 109.
4. Online videos help me to learn concepts
5. Online examples are helpful in making the course concepts very clear
6. The  
online resources presented would improve my learning of ECE 109 materials and be a helpful reference for future courses.
7. The tutorial has increased my confidence to do well in Circuit Analysis Class.
8. The tutorial helps me in employing right technique for solving to a specific type of problem.
9. Which topics are difficult to understand and needs more help?
10. What did you like LEAST about the tutorial?
11. What did you like MOST about the tutorial?
12. Any suggestion to improve?

Answers to questions 1 through 8 are chosen from one of the following: **SD** = Strongly Disagree; **D** = Disagree; **N** = Neutral; **A** = Agree; **SA** = Strongly Agree.

The survey results are summarized in Fig. 5. It shows that 99% of the students taking the survey agree or strongly agree that “online resources presented would improve my learning of ECE 109 materials and be a helpful reference for future courses.” Also, most of the students agree or strongly agree that the online resources enhanced student confidence to do well in Circuit Analysis Class and make course concepts very clear. A number of these students asked if it would be possible to develop similar study aids for other freshman classes such as the introductory C programming course [4].

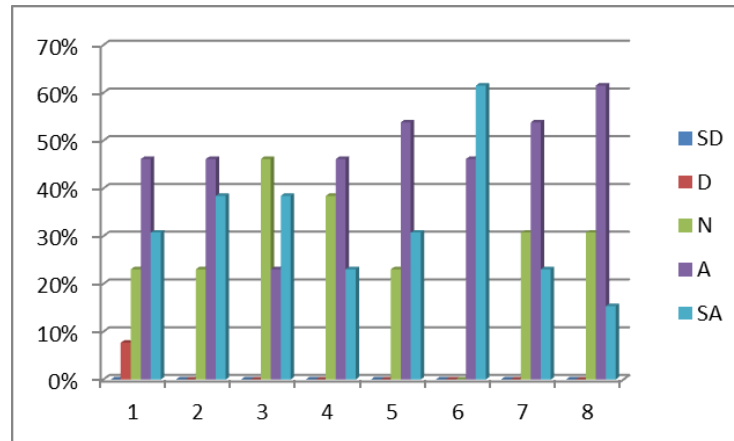

Figure 5. Survey results. (**SD** = Strongly Disagree; **D** = Disagree; **N** = Neutral; **A** = Agree; **SA** = Strongly Agree).

In the fall 2012 and winter 2013 quarters, we offered five sections of our freshman circuit analysis class. Two sections (a total of 82 students) used our course materials. The other students from the remaining three sections (a total of 92 students) were not exposed to our materials. A comparison of the grades received by these two groups is shown in Fig. 6. This data indicates that both the pass rate and the average grade increased in the class whose students used our online web tools.

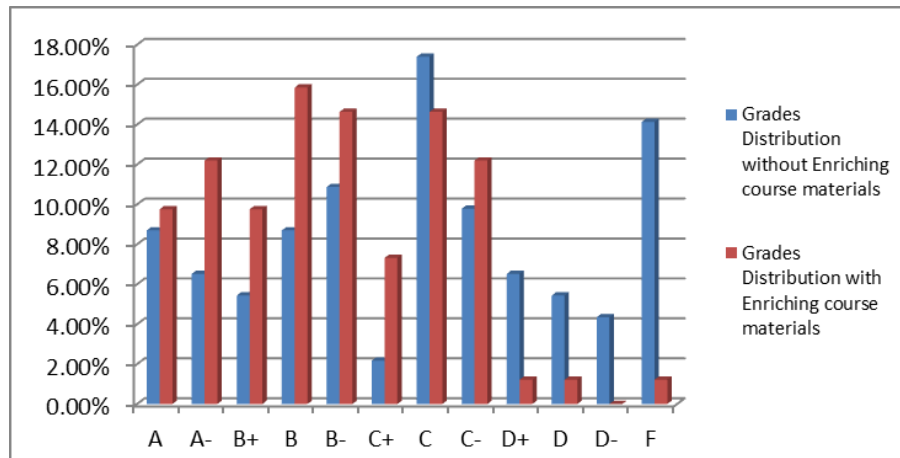

Figure 6. The grade distributions for ECE 109 for two different classes.

## Conclusions

Previous studies [4-7] present different teaching styles and online tools. A suite of web-based instructional tools has been developed and was introduced to freshmen students at electrical and computer engineering in Cal Poly Pomona. Preliminary assessment data demonstrates that students respond favorably to these new learning resources, and also that access to these resources correlated with improved student performance as demonstrated by class grades. Both pass rate and average grade were improved with use of these tools. These learning materials were developed to enrich the introductory electrical circuits course, but are also available to students who need to review. Several important conclusions from this project are listed below:

- The first electric circuits course is one of the significant bottleneck classes for students in our department, having a low pass rate.
- Many different web based resources allow students to choose a format that is most accessible and meaningful to them.
- The YouTube videos of problem solutions are found to be extremely popular with students because it allows a student to clearly see the evolution of the solution process.
- Online circuit simulation software provides students with a means of validating their solutions to given problems, as well as a platform for developing and checking similar problems.
- Use of myDAQ helps students to explore circuit on their own time outside lab. This device also allows students to correlate calculated values with the measured values.
- Students who are using the web tools have indicated that they are more confident about their mastery of circuit analysis concepts.

### **Bibliography**

1. CircuitLab, [www.circuitlab.com](http://www.circuitlab.com)
2. National Instrument's myDAQ <http://www.ni.com/mydaq/>
3. "Incorporation of NI MyDAQ Exercise in Electric Circuits," Catherine Chesnutt and Mary C. Baker, Proceedings of the 2011 ASEE Gulf-Southwest Annual Conference, 2011
4. "Improving Student Learning of Basic Electronic Circuits Concepts using Web-Based Tools," Z. Aliyazicioglu, R. M. Chandra, P. R. Nelson, J. Kuo, and S. Sujanani, ASEE 2014 ASEE Annual Conference.
5. "Recognizing Diverse Learning Styles in Teaching and Assessment of Electronic Engineering," Ayre, Mary and Nafalski, Andrew, IEEE Frontiers in Education Conference, T2B-18, (2000).
6. "Teaching and Learning Styles in Engineering Education," Rajiv J Kapadia, 38th ASEE/IEEE Frontiers in Education Conference, 2008.
7. "Active and Interactive Learning Online: A Comparison of Web-Based and Conventional Writing Classes," B. Mehlenbacher, C.R. Miller, D. Covington, and J. Larsen, IEEE Transactions On Professional Communication, Vol. 43, No. 2, June 2000.

## Teaching and Learning of Database Concepts Using Multimode Teaching Methodologies

Mohammad Amin, Gordon Romney, Pradip Dey, Bhaskar Sinha, and Debra Bowen  
National University

### Abstract

The applications and usage of computers in the Internet, and World Wide Web, have been integrated into society faster than any other major technological change in history. There is a great and growing demand for faster, more powerful, and smaller computers. The use of computers in every aspect of industry, government, academia and research is growing exponentially. The volume of data, likewise, that is used and created has grown at an equivalent or greater rate. Especially during recent decades, database applications have extended into many new usage areas such as computer-aided design and manufacturing, geographical information systems, E-business and real-time intelligent decision making. In this information age, data has become a critical, sensitive and highly valued resource for businesses which cannot be purchased, but can only be generated. Individual sets of data are usually created during business operations and research, and become available for many interdisciplinary purposes. The success of any enterprise depends on how the organization collects, organizes, manages and utilizes data. Fortunately, modern database systems are capable of dealing with all these diverse, critical areas. “Big Data” requirements and cloud technologies are challenging traditional database techniques, and, yet, formal database techniques remain fundamental in resolving the challenges. Database management, by its own nature, is considered a multidisciplinary subject. It is not surprising that this topic remains among the most sought-after and popular subjects taken by students in engineering, science, business and technology disciplines. At most universities, both technical and non-technical graduate and undergraduate programs require at least one database course. Usually, such a course introduces the concepts of relational database design, modeling, implementation and administration. Teaching a database course to students from different disciplines in one class is a challenging task, and, at the same time, it is most rewarding in the creative opportunities provided and outcomes achieved. The authors have taught many database classes over time, and tried various teaching methods using different approaches and technologies. Recently, multimode and agile teaching methods, in graduate-level database courses, were employed that improved the learning process of this highly technical topic. In this paper, critical teaching issues relative to database teaching are addressed and pedagogical approaches to achieving improved student learning are reviewed. Findings of the authors demonstrating improved student learning are supported by tangible metrics including student GPAs and end of course evaluations.

### Introduction

The use of computers, Internet, World Wide Web (WWW), public and private clouds and mobile technologies for delivery of educational material is growing at an unmanageable rate<sup>1</sup>. Today online education has become more popular because of its quality, accessibility and affordability. In a recent research report it was mentioned that 10 percent of adults in the U.S. strongly agree with the quality of online college/university education and another 22 percent support the online offerings<sup>2</sup>. Recently, National University (NU) has made significant innovative improvements on both technology and pedagogy for its online offerings.



During the last decade database applications have extended into almost every aspect of business, including education. For any organization, transactional data is the most valued and critical asset. This cannot be purchased, but can only be generated by doing business. Therefore in this 21<sup>st</sup> century all modern organizations are striving to safeguard their business data from unauthorized access. The success of any business depends on how that organization collects, organizes, manages and utilizes its data. Consequently, database technology is now one of the most popular subjects taken by almost all engineering, science, business and technology majors worldwide. Most modern databases not only consist of numbers and text (alphanumeric), but also contain multimedia data (audio, video, graphics, and pictures)<sup>3,4</sup>. Anything that can be converted into digital form (0s and 1s) can be used as a part of the modern database system. The original Relational Database (RDB) theory was developed by E. F. Codd to manage, by a set of well- defined operations, textual or numeric data in a more reliable manner<sup>5</sup>. With recent advancements in both theoretical and technological areas of databases, relational databases now manage multimedia data also. Object Oriented Database (OODB) systems are designed to manage complex multimedia data but at much slower rates. OODBs, however, are more complex to design and implement<sup>3,4</sup>. Databases for E-commerce, or E-business, are dealing with more complex data structures and facing more challenges in the real world business environments. These E-databases, additionally, are using wireless and cloud communication technologies which are more vulnerable to attack in terms of privacy and security.

The data stored in relational databases is known as structured data, because it is represented in a strict format that uses “relations”. A relation is a two dimensional table that contains a set of horizontal rows and vertical columns<sup>5</sup>. However, many data found in real world applications are not amenable to being structured. Many scientific and statistical data are represented in semi- structured and unstructured formats. The semi-structured data may have certain data structures, but not all the data collected have the identical structure. Some attributes may be shared among many entities, but other attributes may exist only in a few entities. The unstructured data frequently is not of a single data type but, rather, is comprised of a mixture of data types. A typical example of this compound data is a text document that contains other data types of information embedded within it. Web pages using HTML are examples of such compound structures that contain content that is considered to be unstructured data.

### **National University Overview Information**

National University was established in 1971 with the goal of providing lifelong learning opportunities that are accessible, challenging, and relevant to a diverse student population. It is a nonprofit institution dedicated to providing students accredited education, quality service and support; and in a convenient learning environment for the employed students<sup>6</sup>. The university is unique because of its one-course-per-month format, regional campuses for onsite classes and flexible asynchronized online classes for over 100 different graduate and undergraduate degree programs. Students can participate in their classes and complete degree requirements either completely or partially online. The university is well-known for its teaching excellence and values. It strives to serve the community by preparing graduates with high standards of education, training in cutting-edge technology and high ethical standards. The faculty in the School of Engineering and Computing (SOEC) are continually engaged in exploring new types of teaching methods to deliver quality instruction and materials to its students in the real or virtual classroom for higher learning.

## Contributors of This Paper

This paper demonstrates the agile and quality teaching skills of some instructors in SOEC through review and consideration of student learning assessment. These instructors in SOEC are well motivated and trained to adopt new agile, cutting edge technologies as they become available in the marketplace. Some examples of implemented multimode teaching methods and evidences of resulting student learning improvements follow.

## Multimode Teaching

Often people use the frequently-used phrase “*A picture is worth a thousand words*”. This statement is very true as we all have personally witnessed from our own learning experiences. In multimode teaching pedagogy one should use more than one modality of instruction. Multimode learning makes use of the fact that a learner captures information through several, simultaneous sensories and brain pathways. Literature reports that people can understand something better, and retain it longer in memory, when they learn the content in different ways. In the traditional educational system, students learn only by hearing, seeing, reading, writing and doing. Figure 1 shows a histogram of memory retention rates when students learn in this traditional way<sup>7</sup>. With the advancement of technologies students can now learn in many new and innovative ways. The following, Table-1, lists important examples of additional modes of learning.

Table 1. List of some additional popular modes of teaching and learning

- Mode-1: Teaching in lecture mode: Individual students learn individually (without group work)
- Mode-2: Project based teaching mode: Students participate in Group Projects
- Mode- 3: Problem based learning mode: Targeted problem solved by the students
- Mode-4: Agile teaching mode: Effective for a class where students come from different disciplines
- Mode-5: Audio-Visual mode: Highly visual slides/simulations/ videos/Internet/YouTube
- Mode-6: Reflective mode: Ask students to write reflective notes or make reflective presentations
- Mode-7: Asynchronized virtual mode: Distant students can participate anytime from anywhere to get benefits
- Mode-8: Hybrid mode: some classes meet onsite and some through online
- Mode-9: Study tour mode: Field Trip/Educational Tour: Students visit relevant work sites with a tour guide
- Mode-10: Practicum: Students learn by attending seminar/workshop/conference
- Mode-11: Internship/Practical training: Highly experiential
- Mode-12: Social Media: FaceBook, Twitter, LinkedIn, etc. (interacting/chatting with peers/colleagues)
- Mode-n: Multimode: A good mix of several modes in an effective way for better learning

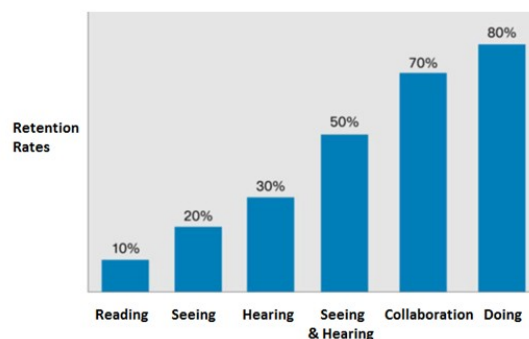

Figure 1. Learning modes vs. memory retention rates [courtesy of Ref. 7].

In a recently published article, researchers discussed the opportunities and challenges of multimode program benefits<sup>8</sup>. In this case, students were given opportunities to work as a teacher and study at the same time under a research-based teacher education program. In this teaching format students were able

to integrate theory and practice into a real, practical context. Another group of researchers recently implemented multimode teaching modes for a Java programming course. In this case, students' 1) learning interest was stimulated, 2) programming skills were increased, 3) analytical skills were improved, and 4) hands-on, or experiential learning was enhanced<sup>9</sup>. Another article discussed the benefits of multimode teaching to school teachers that trained under a practicum program called "The Reflective Practitioner in the School"<sup>10</sup>. Many additional articles have been published on multimode teaching techniques and the resulting benefits to learning<sup>11-18</sup>. In this paper, the authors analyzed one case study and discussed the teaching and learning outcomes that resulted from using multimode techniques.

### **Case Study**

Over the last 15 years one of the authors has been teaching a variety of engineering, computer science, and technology classes including database courses for both graduate and undergraduate students in both online and onsite modalities. This instructor continuously strives to provide quality instructions to students by using a variety of different instructional modes, and reviewing students' assessment feedback in order to facilitate better learning outcomes. For all online classes, NU has adopted the eCollege delivery platform with ClassLivePro. Recently, the university started providing eCompanion (the same version of the online course shell) for every onsite class that greatly facilitates achieving consistency between onsite and online courseware. This change has improved, consistent delivery of content by instructors, and produced greatly enhanced student learning as instructors have been given more latitude to focus on multiple avenues of delivery through multimode teaching.

This instructor strives to present a well-organized and concise discussion of the course material to help students 1) understand new concepts, 2) apply their knowledge effectively, and 3) "think out of the box" to identify and solve new problems. In lectures, the instructor breaks down complex subject matter into easily understandable modules. In the case of theory, he demonstrates the theorems with many examples, and blends theory with practical applications. He encourages communication between students and instructor in the classroom, as well as informal discussions outside the classroom. This helps students clarify topics, and challenges their ability to apply the learned knowledge. He bases his teaching on the belief that the best way to learn is by doing. In comparison, the process of reading examples and studying proofs in textbooks and in lecture notes are valuable resources, but real learning comes through one's own efforts at solving problems, either computational, theoretical, or both. This is achieved primarily through class assignments, but also through in-class discussions and exercises. The instructor views his role as a facilitator for this process. He designs an effective framework in which learning can take place. He then stimulates and nurtures the students' development by giving insightful help of knowledge, techniques, and encouragement. The instructor's goals in teaching are not just to promote learning of the subject matter but how best to apply it in real life scenarios and leverage the analytical skills learned in different future challenges. Helping the students learn to think logically, learn problem-solving methods and techniques, and improve writing skills is a fundamental goal of STEM teaching.

At NU, many graduate and undergraduate programs require at least one course in database technologies which introduces the concepts of relational database design, and database integration and implementation into applications. Teaching a database course to students with different majors or specializations is an especially challenging task. The authors have taught database classes multiple times using multimode teaching methods and achieved remarkable responses to the methods as they have lifted students to a higher level of comprehension. This paper addresses a number of critical topics and shares

the success experienced by multimode database teaching. The paper also discusses positive outcomes of using multimode teaching techniques and the rewarding impact this approach has on student learning. Supportive data for these conclusions include student GPAs and end of course evaluations.

Recently, we have used additional technologies for an onsite database class which include the following: HP tablet, Internet, eCompanion, MS Office, a customized simulation package and custom application software. These classes were computer-equipped classrooms with high speed internet connectivity. All PCs in the class had both audio and video options. The instructor's HP tablet had a built in speaker, microphone, webcam, and free-hand drawing/writing capability. The eCompanion is exactly the same course shell in eCollege that is used for the online class. See Figure 2 for a snapshot of the main page of the eCollege course shell for the database course.

The eCompanion of the database class has course material developed by a subject matter expert (SME) for the online DAT604 database class. Tabs shown in the left pane include course outline, instructor's bio, contact information, university general policies, weekly PowerPoint presentation slides, reading materials, assignments, quizzes, midterm exam, final exam, threaded discussions, chat sessions, project description & guidelines, grading rubrics for individual assignments, prerecorded audio and video files, and research website links. The icons in the upper right corner provide the necessary tools for the course: Course Admin, Gradebook, Email, Live, Doc Sharing, Dropbox, Journal, Webliography, Tech Support, and Help. The instructor conducted all tests, assignment collection, grading, and information exchanges through these tools. eCollege records all course activity in the course shell and students had access to the recorded information 24/7 from remote locations.

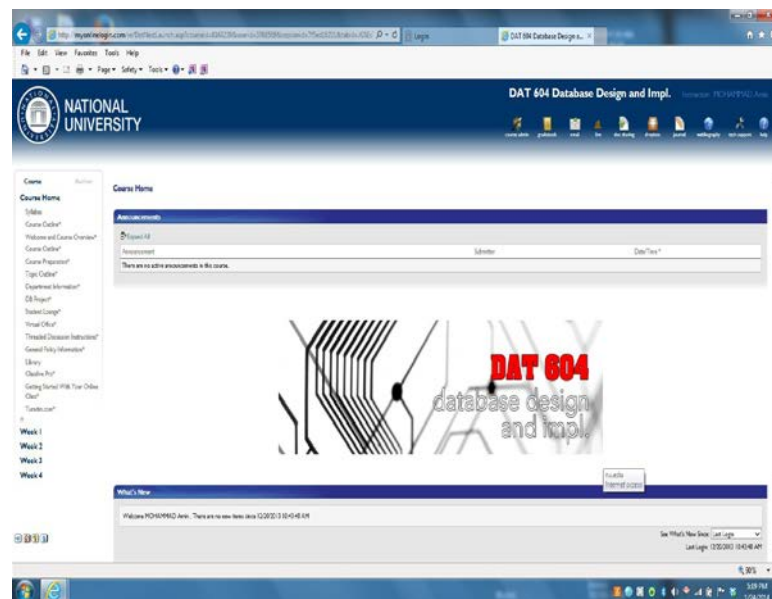

Figure 2. Snapshot of the eCollege main page. <sup>19</sup>

The instructor gave regular lectures using a microphone through ClassLivePro in the eCollege (Live tab) and wrote important/critical notes on the HP tablet screen with a smart pen and shared his desktop with the students on their computer screens. Students could see all the classroom activities on their computers, listen to lectures using earphones and ask questions through the microphone or chat texts. Additionally, students had the full benefit of an onsite class by being in the same room with the instructor. All these

instructional activities were recorded and saved in eCollege. These recorded sessions were made available 24/7 to the students for download and replay at the students' convenience. Figure-3 shows a snapshot of a live interactive presentation (ClassLivePro) screen.

At NU an end of course survey is offered and all students are expected to participate. The onsite class survey is currently being conducted as a hand-written hardcopy while the online class survey is submitted electronically through the internet. In both cases the same questionnaire is used. The survey form used by NU has a total of 22 questions in three major areas: 1) Student Self-Assessment of Learning- 7 question, 2) Assessment of Teaching- 12 questions and 3) Assessment of Course Content- 3 questions. This survey form also allows students to write their comments. Survey participations in onsite classes are always found to be higher in number than the online classes. The university requires that this survey be distributed by one of the students and the instructor is requested to leave the classroom. Survey data is analyzed by the NU Office of the Institutional Research and Assessment (OIRA). A summary of the survey data with student comments are made available to the respective instructors, department chairs and school deans for review and comments. The authors of this paper always review their course survey reports from OIRA carefully and adjust their future teaching plans by improving their pedagogical approach to teaching and adopt different or modified multimode techniques as appropriate.

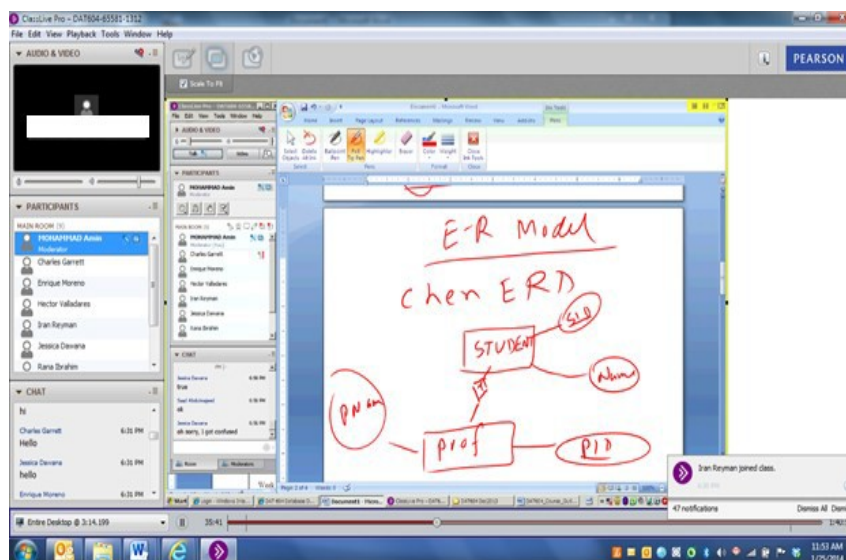

Figure 3. Snapshot of a live presentation screen in the actual classroom. <sup>19</sup>

Table 2 describes the summary of these data for last three onsite DAT604 Database classes taught by Amin, one of the authors. The data in Table-2 indicates that this instructor is consistently receiving high scores on his teaching and students are also learning better.

Students also consistently expressed appreciation for the approach, teaching skills and care of the instructor. Many students explicitly stated on their comments that instructor did an excellent job, explained the topics very well, and presented difficult materials in a simple and understandable format. Instructor used different methods and technologies during the classroom presentations including audio, video, graphic, animated simulations, handouts, and appropriate references. Classes were very organized, structured and well managed. Class time was utilized wisely and interactively with hands on activities. Instructor asked higher level challenging questions to students and expected well thought out

answers. Instructor also encouraged students to ask questions and answered them carefully. Instructor provided a very conducive learning environment where students could get deeply involved and engaged in the class with both instructor and other fellow students.

Table 2. Assessments of instructor's teaching and student learning

DAT604 Classes	GPA	Teaching Mode	Total Students in the Class	Number of Students Responded	Self-Assessment of Student Learning	Assessment of Teaching
May 2013	3.394	Onsite	18	18	4.65	4.81
May 2012	3.342	Onsite	33	30	4.27	4.72
Nov 2011	3.333	Onsite	21	20	4.53	4.70

Another of the authors, Romney, has regularly picked up the students in the course that follows the database course, DAT604, and reinforced the database normalization concepts that Amin taught, by applying them in a Web-Cloud project delivery of a working normalized database. This synergy of reinforcing the same multimode teaching tools in two consecutive courses by two different instructors is an additional proof of the benefit of using multimode teaching methodologies.

### Discussion

The outcomes of this report provide valuable information on both student self-learning assessment and teaching performance of the instructor due to multimode instructional methods in onsite and online classes. After careful review of all data and comments received the instructor was able to use appropriate technologies to provide multimode instructions to the students for better learning. It is clear that properly designed instructional method always helps students understand the subject matters and improve their learning. This report finally confirms that the positive impacts of multimode instructions observed by others at different intuitions are similar. Finally, continuation of the kinds of course assessment discussed in this paper will ensure further improvements to the student learning.

### Conclusions

One DAT604 student comment summarizes the thesis of this paper: "Great job presenting difficult material in a simple and understandable format." The objective of all teachers is to find a way to make the "difficult" subject "understandable." For database instruction that facilitates student comprehension and assimilation of difficult concepts Amin, one of the authors, has succeeded remarkably well in achieving his goal as the previous supporting data shows.

### Acknowledgment

The authors thank other faculty at National University, School of Engineering and Computing, during the continuing research on this subject and the preparation of this paper.

### Bibliography

1. Amin, M., Dey, P., Uhlig, R., and Khan, M. (2011) The Impacts of Direct and Indirect Measures of Assessment of MS in Wireless Communications Program, *Journal of Research in Innovative Teaching*, Volume 4, pages 181-196, 2011.
2. Lumina Foundation and Gallup. (2013). *America's Call for Higher Education Redesign. The 2012 Lumina Foundation Study of The American Public's Opinion on Higher Education*, Lumina Foundation, Indianapolis, IN

- and Gallup, Washington, DC. Retrieved on 12/20/2013 from [http://www.luminafoundation.org/publications/Americas\\_Call\\_for\\_Higher\\_Education\\_Redesign.pdf](http://www.luminafoundation.org/publications/Americas_Call_for_Higher_Education_Redesign.pdf)
3. Harrington, J.L. (1999). Object-Oriented Database Design Clearly Explained, Morgan Kaufmann, ISBN-10: 0123264286
  4. Date, C.J. Darwen, H. and Date, C.J. (1998). Foundation for Object / Relational Databases: *The Third Manifesto*, Addison-Wesley, ISBN-13: 9780201309782
  5. Codd, E. F. (1970). A relational model of data for large shared data banks. *Communications of the ACM* 13 (6):377.
  6. General Catalog (2014). National University, La Jolla, California. [www.nu.edu](http://www.nu.edu)
  7. DAT604: Database Design and Implementation, NU eCollege). National University, La Jolla, California, <http://online.nu.edu/> (available to authorized users only).
  8. SOAR, (2014). National University Database, <https://nus.soar.cci.nu.edu/> (available to authorized users only).
  9. Wang, J., Ruan, Y., Zhang, X., and Zhou, X. (2013, June), Application of Multi-mode Teaching Based on Project and Case Driven in Java Programming Course, *2013 International Conference on Education Technology and Information System (ICETIS)*, Sanya, China, retrieved on 1/25/2014 from <http://www.atlantis-press.com/php/pub.php?publication=icetis-13>
  10. Gilakjani, A. P., Ismail, H. N., and Ahmadi, S. M. (2011). The Effect of Multimodal Learning Models on Language Teaching and Learning, *Theory and Practice in Language Studies, Academy Publisher*, 1(10), 1321-1327.
  11. Ainsworth, S. (1999). The functions of multiple representations. *Computers and Education*, 33, 131-152.
  12. Dubois, M., and Vial, I. (2000). Multimedia design: The effects of relating multimodal information. *Journal of Computer Assisted Learning* 16, 157-165.
  13. Healey, P., Narayanan, N. H., Lee, J., and Katagiri, Y. (2002). Introduction: interactive graphical communication. *International Journal of Human Computer studies*, 57 (4), 243-246.
  14. Kress, G. R., and Van Leeuwen, T. (2001). Multimodal discourse: The modes and media of contemporary communication. London: Edward Arnold.
  15. Vaughan, N., 2007. Perspectives on Blended Learning in Higher Education. *International Journal on E- Learning*, 6(1), pp.81-94.
  16. Mayer, R. E., & Sims, V. K. (1994). For whom is a picture worth a thousand words? Extensions of a dual-coding theory of multimedia learning. *Journal of Educational Psychology*, 86, 389-401.
  17. Moreno, R., & Mayer, R. (2007). Interactive multimodal learning environments. *Educational Psychology Review*, 19, 309-326.
  18. Garrison, D. R. & Kanuka, H., 2004. Blended learning: Uncovering its transformative potential in higher education. *The Internet and Higher Education*, 7(2), pp. 95-105. Retrieved on 12/20/2013 from <http://linkinghub.elsevier.com/retrieve/pii/S1096751604000156>
  19. National University Online Class Materials in eCollege, Authorized Users only. Retrieved on 1/25/2014 from <http://myonlinelogin.com>

## Translating Best Practices for Student Engagement to Online STEAM Courses

Brian Arnold and Jodi Reeves  
National University

### Abstract

As universities continue to offer more distance education through online courses, they face the challenge of translating onsite best practices into online courses in order to enhance student engagement, improve student persistence, and optimize student retention in STEAM (Science, Technology, Engineering, Arts, and Math) programs. This paper describes how we adapted face-to-face classroom engagement techniques related to group discussions (both synchronous and asynchronous) and labs into online courses in applied engineering and digital media design at National University.

### Introduction

The past decade has witnessed more universities offering online courses and degree programs as both traditional and nontraditional students look for flexible undergraduate and graduate education options. Over 62% of US colleges and universities are now offering some sort of online programs with 6.7 million students taking online classes in 2011, up from 6.1 million the previous year.<sup>1</sup> One source predicts that there will be more full-time online students than the onsite students in the next few years.<sup>2</sup> Those courses which are not delivered entirely online are still highly likely to feature hybrid or blended online resources.

National University (NU), a non-profit, private university founded in 1971, features over 50% online delivery across its hundreds of academic programs. In total, NU offers about 100 undergraduate and graduate degrees to approximately 23,000 students, with 70 programs and 1,200 courses being online and accredited by WASC (Western Association of Schools and Colleges).<sup>3</sup> NU provides more master's degrees in education to minority students than any other college or university in California, as well as more master's degrees in all disciplines combined to the state's Hispanics and African Americans, according to *Diverse Issues in Higher Education*. Annually, National University also ranks in the Top 10 nationally in granting master's degrees to women.<sup>4</sup> Currently, NU offers courses delivered in a single month format, using one of four synchronous and asynchronous delivery models:

1. Onsite classes: These are the traditional face to face classes with instructors and students in one classroom at the same time. The classes are offered on nights and weekends to enable students who are employed during the day to attend classes around their work schedule.
2. Online classes: These are asynchronous classes where students can access course content at anytime and anyplace.
3. Web-based classes: These are synchronous classes where some students are in the onsite classroom and some are connected to the classroom at the same time via internet.
4. Hybrid classes: In these classes students get 50% instruction from the onsite classroom and 50% from the online class website.

In 2002, National University founded what is now the School of Engineering, Technology, and Media where almost half of the students in the applied engineering department are enrolled in online courses, over half of the computer science department are enrolled in online courses, and 100% of all the media



students matriculate online. The university's goal is to provide the same high standard and quality of education to all students in both onsite and online courses, no matter what delivery model is used. This paper focuses on how we've adapted persistence techniques for improved student engagement, interaction, participation, ownership, and community to STEAM online courses in applied engineering and media at National University.

### **Literature Review**

When STEAM (Science, Technology, Engineering, Arts, and Math) education is delivered online, student retention and persistence issues increase since online delivery combines all of the traditional challenges of race, gender and K-12 preparation with a delivery model that relies heavily on student ownership of learning and proactive engagement. Even though more students are choosing online education, the literature shows that attrition rates are higher in online courses than in onsite courses. Specifically, attrition rates for classes taught through distance education are 10–20% higher than classes taught in a face-to-face setting. One example of this was described for Tel Aviv University, where the activity of 1189 students in 1897 courses were analyzed and showed that 46% of students either decelerated or quit their online activity by the end of the course.<sup>5</sup>

As the number of online courses continues to increase it is critical that educators put together a proven and effective framework for engaging learners if they wish to increase student retention and persistence. Engaging students' attention early and rigorously keeping them focused on relevant curricula is the key. In order to successfully and consistently engage their students, educators must be armed with techniques and strategies adapted for teaching effective online courses.<sup>6</sup> The often missed opportunity for universities moving courses from onsite to online is the chance to evaluate their practices and only transport over the ones which show the most promise of student engagement and a robust fitness for the online delivery environment. However, initial attempts to adapt onsite teaching methods to online courses achieved little more than copying onsite practices into the digital environment. The sage remained on the stage, simply changing the performance venue. Unfortunately this does not encourage student retention or persistence in either classroom mode. Newer teaching models like the flipped classroom, peer engagement, and student-led engagement are finding favorable results and increased engagement both onsite and online.

According to Dr. Ben Habib in his paper, *Breaking the Ritual*,<sup>7</sup> effective classroom participation requires that students be familiar with key concepts from the topic reading material. His suggestion is that effective classroom engagement works on the flipped classroom model, wherein the majority of factual content is ingested outside the class meeting and the class itself is a place to review, reinforce, troubleshoot and workshop key course concepts. The paper urges instructors to resist the sage on stage model of lecture or frontal presentation and instead focus on creating an inclusive and engaging environment for student learning. The intervention had two primary components; first, a large portion of the initial tutorial was devoted to introductory activities in which the students got to know each other [peer engagement]. Second, subsequent tutorials began with a paired warm-up activity to get the whole class talking immediately, after which each student raised a prepared question for class discussion [student led engagement]. In this way, less confident students can participate in class discussions, more confident students can be managed so they don't monopolize class discussions, and students are enabled to take responsibility for their efforts. This flipped classroom model, with a new structure and tutorial components were used in online classes in applied engineering and media at NU and will be discussed in further detail in the Results & Discussion section.

Engaging learning experiences in STEAM are challenging to design, develop, and implement; in the case of online classes, the students are not physically present which presents additional obstacles. In an online classroom, instructors must begin by building a method of communication within student groups and between students and instructor, and then fashioning the available communications in such a way that students are able to participate in the social exchange of information in a virtual environment.<sup>5</sup>

Typically online classes use two forms of communication between students and instructor. In the synchronous, or real-time, mode the instructor and students meet in a “live” chat session using real-time audio or video and messaging capabilities. In the asynchronous mode, students interact with course materials individually such as watching taped presentations by the instructor, contributing to discussion boards, or reading information that has been linked to the course. In Davidson and Tanner’s, *How Do Students Participate in Synchronous and Asynchronous Discussion*,<sup>8</sup> developers of online learning environments suggest that asynchronous communication may have advantages over synchronous communication and are the preferred mode of discussion. A study by Piburn and Middleton compared asynchronous discussions on a listserv (used for software for managing e-mail transmissions to and from a list of subscribers) to face-to-face classroom discussions, focusing on professor and student interactions. They found that asynchronous held some advantages over the traditional classroom, such as student preferences for the listserv and noted a role reversal with students initiating the conversations rather than teachers.<sup>9</sup> Noting an absence of any analysis or evaluation of online chats in the literature, Jeong found in his analysis that these types of synchronous discussions had a main advantage of promoting highly interactive discussions with a disadvantage for the group to digress from the topic to another.<sup>10</sup> The use of synchronous chat sessions and asynchronous threaded discussion were used in online applied engineering and media classes and will be discussed in further detail in the Results section.

When learners are able to interact with their classmates and instructor, it helps to engender a sense of participation in a true learning community. A learning community comprises individuals participating together in joint activities who have a sense of belonging to one another. Further, that sense of community (SOC) can be fostered through interaction with others who have similar interests and goals.<sup>5</sup> SOC appears to be related to both student-instructor interaction and student- student interaction. In a study of 1,406 students across an entire university system, Swan found a significant positive correlation between students’ perceived interaction with instructors and fellow students and their satisfaction within their online courses.<sup>11</sup> Meanwhile, Woods found in a single course study that a significant relationship exists between student-instructor interaction and learner satisfaction. Interestingly, in Woods’ study there was not, however, an increase in student satisfaction, learning, or sense of community in response to increased personal e-mails from the instructor.<sup>12</sup> Therefore, increased engagement doesn’t seem to be a result of ongoing or frequent communication touch points throughout the course. Rather, increased student engagement in elegantly cultivated SOC settings is the product of an instructor clearly establishing the tone, expectations and interaction level for the course during its earliest meetings. Once properly established, peer interaction becomes the self-sustaining engagement mechanism. Further, this research suggests that instructors may be able to foster interactive relationships with their students, with students perceiving a high degree of instructor availability, with only a minimal amount of initial reciprocal interaction such as video lectures, occasional whole-class announcements, and prompt reply to individual student e-mails (typically within 24 hours). To build community in online classes at National University was the goal of the use of Google Jockey (an induction activity at the start of a live

session wherein the students went online, searched for information on the day's discussion topics and then presented them to the class) in media classes and the use of break-out chat sessions in applied engineering, which will be discussed in further detail in the Results & Discussion section.

## Results and Discussion

### *Building community through the application of instructor video*

For synchronous portions of online classes, one obvious tool for fostering community and increasing engagement is to have the video camera active during live sessions. Students able to use body language to express themselves will be more robust communicators. While nearly all live session solutions include a live video tool, current home online bandwidths and server speeds often result in this function being disabled in order to preserve the continuity of the connection. As commercial bandwidth continues to follow Moore's law, the video tool will enjoy greater adoption.

Some very simple tools can be used to make an asynchronous online course feel more personal (and therefore more engaging for the students) while building a sense of community in the class. Posting an instructor portrait and creating a space for students to (optionally) post their own portraits can improve student's sense of community. Instructors can make a simple video of themselves introducing the course and their credentials. This allows the student to put a face to the name, while simultaneously sampling the voice they will hear in their heads when they read instructor feedback. This can go a long way to regulating the tone with which students read instructor posts.

*Increasing participation through the application of targeted assessment.* Another general method of encouraging online live session participation is to build in assessment measures which can only be fulfilled by meaningful participation. If 10% of the courses grade relates to the live session, student risk losing a whole letter grade if they absent themselves from the sessions. Within that 10% a portion should be dedicated to attendance (showing up) and a portion to meaningful participation. So, the student who shows up but never says anything fails to earn the full 10%.

Similarly each assessment, attendance and participation, should have a clear rubric posted to the course showing students exactly what they need to do in order to be successful. An example rubric from an applied engineering course is shown below. In this case, class participation was worth 25 points for each week (12.5 points each chat session; there were two chat sessions conducted each week). The rubric specifies how the student will be graded based on Quantity of Participation and Quality of Participation as shown below.

Table 1. Participation Grading Rubric

<b>Participation</b> (Scale of 0-12.5)	<b>Quantity</b>	<b>Quality</b>
<5 points = <b>Low performance</b>	Absence = 0 points.	Little to no interaction during chat sessions. Logged on and remained silent.
5-10 points = <b>Moderate performance</b>	Attended most of the class, but either came late or left early	Some interaction with instructor/classmates during chat sessions. No verbal contribution during chat sessions.
10-12.5 points = <b>High performance</b>	Attended entire class	Good verbal contributions during chat sessions showing understanding of the knowledge and application of the topic area.

Rubrics were also developed to encourage student participation in threaded discussions, which is done asynchronously. The educational goal of threaded discussions is to give students an opportunity to reflect on the textbook material and the class discussions and synthesize this knowledge into understanding of the weekly course learning objectives. For this applied engineering course, the threaded discussion assignments were graded based on Quality of information and Delivery of Information as shown in the rubric below.

Table 2. Threaded Discussion Grading Rubric

Threaded Discussion (On a scale of 0-25)	Quality of Information	Delivery of Information
<10 points = <b>Low performance</b>	Response is not related to the assignment; irrelevant remarks are made; response did not answer all questions.	Poor spelling and grammar, "hasty" appearance, professional vocabulary not used, and attitude negative or indifferent.
10-20 points = <b>Moderate performance</b>	Response is related to topic; supporting details or examples are not included in sufficient breadth or depth; the author simply restates concepts made by others (textbook, instructor).	Few grammatical or spelling errors, professional vocabulary used most of the time, and positive attitude displayed frequently.
20-25 points = <b>High performance</b>	Supporting details and examples are both broad and deep; the author shows originality and does not restate the textbook or instructor; all questions are answered.	Consistent grammatically correct posts with professional vocabulary, no misspellings, and positive attitude displayed throughout.

*Building participation through adaptive presentation styles in group discussions.* National University's School of Engineering, Technology and Media hosts an undergraduate degree in Digital Media Design. Delivered completely online on the eCollege learning management system in one month long courses, students are asynchronously exposed to a spectrum of technologies and design principles centered on the creation of satisfying user interface. Each course holds weekly synchronous "live" sessions hosted through either the eCollege ClassLivePro or independent use of AdobeConnect. Either way, the students are expected to congregate and attend the live sessions traditionally held late in the evenings. For their capstone experience two months are devoted to MUL 420 and students are held to a rigorous program of weekly portfolio and thesis milestones. The task of aggregating the best of their 3-4 years' worth of work to a web site, assessing which pieces both represent their skills and could look attractive to employers while simultaneously generating 4,000+ words per week on their thesis is daunting. Outside feedback is essential for the optimal production of marketable work and so ensure maximum metacognition on behalf of the students who are about the begin independent monitoring of their own professional development. To that end the weekly group discussions in the flipped classroom model become even more essential for success in this high- stakes, time-locked scenario.

In group discussions, one method for engaged and fruitful student interaction involves the delicate balance of both establishing authority while simultaneously creating a safe and welcoming environment for students to take risks and brainstorm solutions. What has shown itself to be effective in MUL 420 is the instructor's adoption of the first-among-equals persona. The live session begins with a shock-and-awe review of their credentials; essentially covering how they, they instructor, have done this process

successfully in the past and therefore have credibility. The three key areas to touch upon are subject matter expertise, professional industry experience and teaching credibility. Once authority has been established, the instructor makes a few calculated self-deprecating comments, shares a story of a professional mistake or error and how it was remedied can break the ice and catalyze the aforementioned goal environment.

The use of each student's name when calling on them (an easy task in an online chat where everyone's name is displayed for easy reading) and even calling on the quiet ones when a question is presented to the group can heighten engagement and risk taking. One of the primary keys to this method being successful is the instructor's ability to read their students as individuals and as a group. The instructor who can detect shyness, fear, discomfort or anxiousness in a student and address it in a way that allows the student to save face will win over the group and enhance participation. In the flipped classroom model, if the instructor cannot deviate from their planned agenda for the meeting, it means that they are not reading and adapting to their students and this approach will fail. In order to maximize engagement, the attending students must be made to feel safe sharing their thoughts. This is done by the instructor showing a combination of competence and vulnerability. Once students feel safe and encouraged, participation increases and the level of engagement with the material or the problem solving process rises.

*Increasing participation in applied engineering laboratory courses.* In the applied engineering department, a class in scientific problem solving (EGR 320L) was taught to 28 online students in Fall 2013 using laboratories in mechanical engineering, electrical engineering, and thermodynamics. The students were a mix of computer science and applied engineering majors; the online students took the course asynchronously from multiple locations throughout the United States plus one military student serving in Afghanistan. The online course utilized live webcam-broadcast laboratory demonstrations as well as hands-on laboratory equipment that was shipped to each student to create remote labs and adapt hands-on laboratory learning to online courses as described in other publications.<sup>13,14</sup> Live synchronous chat sessions, asynchronous threaded discussion questions, and other tools and technology were used with the online class to try to inspire and engage students in the challenging laboratory course material. Scheduling live synchronous group discussions in an online environment provides unique challenges, but it is possible through the use of National University's use of eCollege hosted ClassLivePro (CLP) technology, part of the eCollege learning management system that allows instructors to gather students into a large virtual chat room or divide them into smaller groups in separate chat rooms. Within these smaller group chat rooms, each student has audio, video, and whiteboard access to discuss ideas and document notes during the session. The instructor can jump in and out of each group's concurrent chat room sessions in order to encourage and guide students during the discussion. Once complete, the instructor can pull the whiteboard notes back to the main online chat room and reconvene the whole class for individual group reports. The use of this technology tries to closely emulate the onsite interaction between one instructor and several small groups of students in an online laboratory.

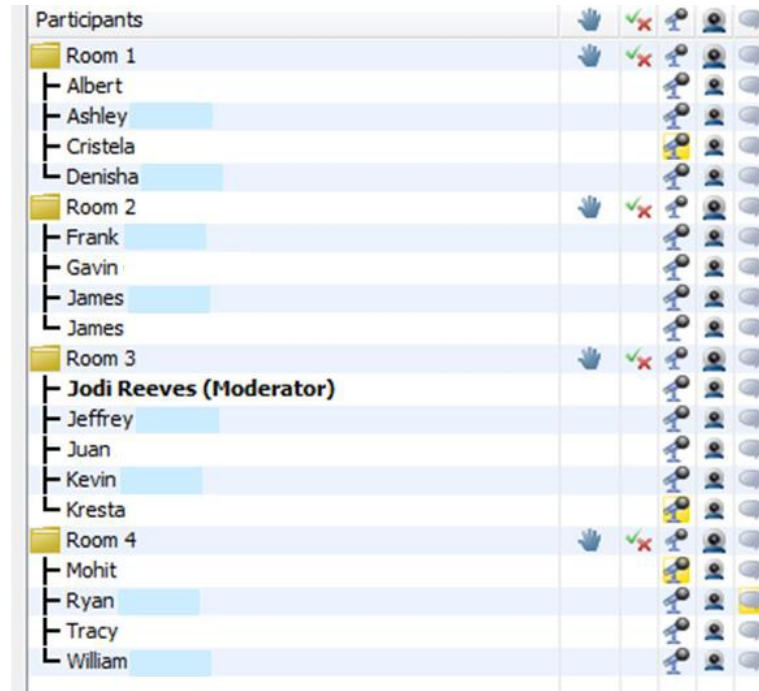

Figure 1. CLP session for small group participation.

In one thermodynamics laboratory preparation, the instructor emailed a sample lab report to the class with instructions to analyze the strengths and weaknesses of the lab report. During the synchronous chat session, the instructor then divided the online students into small groups and placed them in an individual chat session where their task was to grade the lab report using the rubrics that the instructor usually uses. Using the CLP technology described in the previous paragraph, the instructor could then visit the individual chat rooms (shown as Room 1, Room 2, etc. in Figure 1). The instructor could see who was using the microphone when it was highlighted in yellow (the microphone icon in the 4th column in Figure 1) or who was typing in the chat window (the balloon icon in the 6th column in Figure 1).

At the end of the activity, the whiteboard notes from each small chat room were brought into the main chat room for student presentation. Then a spokesperson from each small group described their group results to the whole class. An example of the student-graded lab report is shown in Figure 2, which is the Whiteboard output of the main chat room in the CLP session.

Whiteboard - Main Room (Scaled 170%)  
Room 2 - Thermodynamics Lab

65/200

## Thermodynamics Lab

No mention of thermodynamics or desired learning outcomes

- 10\* (25) Introduction (*Why?*)
  - Learning Outcomes
- 10 (25) Experimental Procedures (*How?*) Simply copied instructions, nothing was added. No ice water test was done. Experiment would be impossible to reproduce with info given.
  - Steps in sample preparation
  - Thermometer calibration
- 15 (50) Data from thermodynamics experiments (*What?*) Layout of graphs was awkward. Experiment was only half done. Chart is labeled with only 25 min. of data.
  - Heat transfer in hot material (coffee)
  - Heat transfer in cold material (ice water)
- 25 (50) Results & Discussion (*So What?*) Precision is unreasonable for a thermometer. Again, only 25 minutes of half the assigned experiment shown. No description of how statistical analysis was determined.
  - Graphical results: temperature vs. time
  - Statistical results:  $\Delta T/\Delta t$
  - Discuss how the graphical and statistical results compare
  - Discuss the heat transfer mechanisms (conduction, convection, radiation) in your two samples
- 5 (25) Conclusions Conclusion didn't say anything.
- 5 (15) References What textbook? No other references.

Figure 2. CLP session for student presentation at end of small group activity.

Student self-assessment of this synchronous small group activity was overall positive, with many suggestions for improvement in the future. The biggest hurdle that needed to be overcome was the fear of trying something new, from both the instructor and the students. Even though over half of the students had taken at least five online courses previously, none had been in a class that used this small group chat function of CLP. The CLP technology enabled a smooth transition of almost 30 online students being moved into small group chat sessions. Some students immediately started to dominate the discussion in their own group, and the instructor had to intervene appropriately. In other groups, participation was sluggish at first with only a few text messages appearing in the chat window, rather than students taking the microphone to discuss the assignment with their classmates. Rapid and appropriate instructor response was key to guiding and motivating the student participation in the CLP chat sessions, just as instructor intervention is needed in onsite classes to keep students on task and participating in the activity.

*Building student ownership through the application of Google Jockey.* Google has a host of tools to facilitate online participation and engagement, from Google Hangouts (a dynamic discussion space) to Google Docs (an interactive document sharing platform). At heart though, Google itself can be harnessed to stimulate robust participation in live online chat sessions, which is known as Google Jockeying. A Google Jockey is a participant in a presentation or class who surfs the Internet for terms, ideas, web sites, or resources mentioned by the presenter or related to the topic. The Jockey's searches are displayed simultaneously during the presentation, helping to clarify the main topic and extend learning opportunities.<sup>15</sup>

The value in synchronous live chat sessions with a Google Jockey is that it both acknowledges that the participants are online and probably surfing during the session while redirecting that activity away from Facebook and sports scores in to course related content. The target of their search should be one to three examples of a key concept or idea covered in the session. By having the students find and deliver the information to the class, the sage on the stage atmosphere transforms into a student driven presentation while also serving as an induction activity that fosters risk taking, participation and community. If any

student-presented information is incomplete (or wrong), the instructor can step in and redirect the focus. The presentation of student found facts, by the students themselves, can quickly become an organic discussion about both the real world application of these facts (relevance) and a higher order analysis of concepts and meaning. Attributes of a good Google Jockey include having a focus on the topic at hand, the drive to explore key concepts, and the goal of stimulating peer feedback. In summary, this method allows the students to present the main ideas, thereby adding a sense of ownership to their learning while fostering participation and community.

*Increasing communication quality within asynchronous threaded discussions.* The asynchronous threaded discussion is a text-based interaction that can be often sterile at best and can be rife with misunderstood tone, meaning and intentions at the worst. Because this form of interaction lacks body language and tone of voice, much of natural communication requires simulation or replacement in order to achieve robust discussion without misunderstandings. To begin, the threaded discussion question should be an open ended question, promoting debate, discussion, investigation and inquiry. In EGR 320L, Scientific Problem Solving Lab, examples are shown below for mechanical engineering threaded discussion questions: “You are walking down the road, listening to your iPod with your earbuds. You trip and your iPod tumbles out of your pocket but is caught by the cable connecting it to your earbuds. How would you calculate the stress in the cable? What assumptions would you have to make? What equations and data would you use?”

For the iPod tripping scenario above, how would you calculate the elongation in the cable? What assumptions would you have to make? What equations and data would you use? You were lucky when you tripped - the cable was strong enough to support the weight of the iPod when it flew out of your pocket. What's the maximum weight that can be supported by the cable attached to the earbuds? How could you test this experimentally?

Examples for electrical engineering threaded discussion questions used in EGR 320L are also shown below: “If you had a meter to investigate the electric power system in your home, what would voltage would you measure for the electricity coming into your home? What frequency is the power coming into your home? Do all devices in your home operate at this voltage and frequency? How do you know?”

Appliances A, B, and C consume 250, 480 and 1450 watts of power, respectively. The system voltage is 120V, and the circuit breaker is rated at 15 amps. Which combinations of the three appliances can be on at the same time, and which combinations will trip the circuit breaker? What assumptions would you have to make? What equations and data would you use? Look around your home at some common appliances - a toaster, fan, space heater, television, computer, etc. Which appliances would you predict draw a lot of current to operate? Which appliances would you predict take a lot of power to operate?

Extra credit project: if you would like to investigate this, there is a device called Kill-A-Watt that can measure current, voltage, and power when electrical devices are plugged into them. Measure 10-15 devices in your home and write a mini lab report describing your data and lessons learned by taking these measurements. And finally, the examples below are for thermodynamics and fluid dynamics threaded discussion questions in EGR 320L:

- *Thermodynamics at home:* The textbook states, “Common household appliances such as dishwashers, microwave ovens, refrigerators, humidifiers, clothes dryers, toasters, water heaters, irons, and pressure cookers rely on principles of thermodynamics for their operation.” Choose



one of these, or another household appliance, and describe what thermodynamic principles are at work.

- *Heat transfer and hot coffee:* You are going on a long road trip and want to take a mug of coffee with you. You would like the coffee to stay as warm as possible for the longest amount of time. What kind of coffee mug would you take with you? Discuss the mug material, size, and other factors that would affect heat transfer (which can occur by conduction, convection, and radiation).
- *Fluid mechanics and transportation:* The textbook states, “The analysis and design of virtually every type of transportation system involves the use of fluid mechanics. Aircraft, surface ships, submarines, rockets, and automobiles require the application of fluid mechanics in their design.” Explain what principles of fluid mechanics are at work in one of these transportation systems.

Once a clear and thought provoking question is posted in the discussion thread, the instructor’s next step for engaging the students is to make sure that the discussion is both meaningful and vibrant. Students often post comments in a stream of consciousness format, neglecting to check for homonymic errors, let alone tone and meaning. As an instructor, there are methods for setting the tone and controlling it as the discussion threads evolve. The choice of language for the question itself suggests the manner in which students will respond. A sloppily spelled, grammatically egregious, or poorly constructed question will likely elicit mirrored attributes in the discussion response. Therefore clear, direct and professional language is essential. If student responses are terse or lack detail, the instructor should prompt them for more detail or ask a new, leading question. For example, this is one threaded discussion question from MUL 300 Convergence Media: “What is interactivity? This is a term casually tossed about in the digital media sphere, but we often fail to consider what it really means. When a client asks for “interactivity” on their web site, it could mean a dozen things. How would you articulate your definition to a client?”

A student response might be, “Interactivity means that the user can interact with it.” An instructor response designed to enhance the threaded discussion might be, “That is a good start, and would you expand on that idea and strive for a definition which does not contain the word itself? List a few specific examples which help illustrate your point.” By acknowledging the value of the student’s initial post and then suggesting areas for improvement the student can enhance their answer without losing face. There are times when the delivery of feedback becomes a delicate act of diplomacy and there are many symbols and phrases which can not only soften the blow of unpleasant news, but give it the tone intended by the instructor. Questions which can soften the blow of pointing out an error or clarify meaning are listed below:

1. Have you considered...
2. Would you please elaborate...
3. Please provide more examples...
4. Help us to better understand what you mean by...
5. What I am hearing [reading] you say is...

In the online Media Storytelling course BRO305, we use Alt-code symbols and persuasive punctuation as ways to increase communication in asynchronous threaded discussions by simulating tone and body language. These techniques are most effective when the students are made aware that they are participating in a formal space and the use of these tools is not to simulate texting, emails or other informal modes of communication, but rather to clarify text based tone and meaning. The goal of

clarifying meaning serves to enhance communication and serve as a tool for engaging students who feel comfortable taking risks and participating in rich dialog in the threaded discussions. Persuasive punctuation is also a handy tool for achieving tone in a threaded post! The judicious use of punctuation and icons (emoticons) can turn a sentence with multiple meanings into a singular directive. For example, the feedback “Nice job” can be read sincerely, enthusiastically, or dripping with irony and scorn. “Nice job!” drastically narrows down the range of possible misinterpretations.

Online text based interactions create opportunities for miscommunication which hurt feelings and often lead to students distancing themselves from the discussion or even the entire course. The unique source of these miscommunications in threaded discussions is the fact that unlike face-to-face interactions, text based interactions lack both body language and tone of voice, two primary methods of communicating. To offset this deficit in written communication, Digital Media Design course instructors have experimented with the application of ALT code icons to offset the lack of tone in the written word. While it is possible for the instructor to simply type “Just kidding.” or “Ha-ha!” the insertion of a ☺ at the end of sentence makes it clear that the statement is meant to be delivered by a smiling speaker. Feedback is much easier for students to digest when delivered by a friendly and empathic evaluator. ALT Code icons can help to reinforce that perception on the part of the student.

Icons can easily be integrated into instructor responses if they have either memorized or have access to a translation of alt-codes. Standard ALT codes can liven up and clarify text. To use them simply hold down the ALT key (works best on the 10 key pad to the right on a standard QWERTY keyboard) and type in the indicated number on the number pad. The Smiley face ☺ is ALT-1, the upward arrow ↑ is ALT-24. It requires a few moments practice, then empowers the instructor to give more precise meaning to their feedback. Figure 3 shows a variety of useful ALT Code symbols which may enhance tone in asynchronous threaded discussions.

NUMBER	1	2	3	13	14	15	24	25	26	27
SYMBOL	☺	☹	♥	♪	🎵	☀	↑	↓	→	←

Figure 3. ALT Codes with number and related symbol

The introduction of emotive elements which correlate to the arenas of texting, emails, chat rooms, and informal conversation require that an equal and diplomatically offered counter element be introduced: namely the explicit delineation between formal and informal spaces. The course structure and instructor must make it explicitly clear that the classroom live sessions and discussion threads are formal spaces requiring formal grammar, punctuation and professional conduct. A smiley face emoticon may signal informality to some, but it must be made clear that it does not grant permission for absent punctuation, incomplete sentences, or inappropriate discourse. Encouraging participants to choose text color during a live chat also heighten ownership while serving as an innocuous ice breaker. In summary, student creativity arises when students feel comfortable taking risks. The ideal environment for student participation is relaxed and safe, but not informal. The air of professionalism must prevail for these communication tools to yield positive results. The tone is set, modeled, and maintained by the instructor. The delicate balance between formal and informal is established by clearly establishing hierarchy, credentials, and assessment criteria for the course. During discussions, the instructor is still the subject matter expert, but they can allow expression of dissenting ideas, methods, and questions in pursuit of the course goals. By maintaining a first-among-equals status in the discussion, the students can hold to the formal standards of discussion, trusting that there is authority-at-rest watching over the process. The

goal of borrowing these conversational tools from casual communication and applying them to asynchronous threaded discussions is to increase the accuracy of formal communication, supplementing the missing body language and tone, and yet not compromise content or behavioral integrity.

### Summary & Conclusions

Overall, including approximations of onsite social norms into the online environment can help improve student engagement, learning, and persistence in both synchronous and asynchronous learning modes. These techniques and tools can be as simple as the use of emoticons from ALT codes and persuasive punctuation or as personal as posting instructor portraits and using real-time videos as a way to connect students to the instructor in online classes. The inclusion of induction activities like Google Jockey at the start of synchronous, live online chat sessions can increase student engagement, sense of ownership and risk-taking potential, thus allowing for a closer approximation of the rich interplay afforded in face to face learning while leveraging the endless resources of an online setting. Flipping the classroom, designing open-ended threaded discussion questions, implementing clear participation grading rubrics, utilizing adaptive presentation styles, and including new technologies like the CLP small group chat sessions into online classes help improve student participation, sense of community, and persistence.

### Bibliography

1. Sheehy, K. (2013) Online Course Enrollment Climbs for 10th Straight Year. *US News & World Report*. Retrieved on 1/30/2014 from <http://www.usnews.com/education/online-education/articles/2013/01/08/online-course-enrollment-climbs-for-10th-straight-year>
2. Nagel, D. (2011) Online Learning Set for Explosive Growth as Traditional Classrooms Decline. *Campus Technology*. Retrieved on 01/29/14 from <http://campustechnology.com/articles/2011/01/26/online-learning-set-for-explosive-growth-as-traditional-classrooms-decline.aspx>
3. Western Association of Schools and Colleges website [www.acswasc.org](http://www.acswasc.org)
4. National University website [www.nu.edu](http://www.nu.edu)
5. Angelino, L.M., & Natvig, D. (2007). Strategies to Engage Online Students & Reduce Attrition Rates, *4*(2),1–14.
6. Hershkovitz, A. & Nachmias, R. (2011). Online Persistence in Higher Education Web-Supported Courses. *Internet and Higher Education*, *14*(2), 98-106.
7. Habib, B. (2007) Breaking the Ritual: Getting Students to Participate in Discussion-based Tutorials in the Social Sciences, in *Enhancing Higher Education, Theory and Scholarship, Proceedings of the 30th HERDSA Annual Conference*, Adelaide, 8-11 July 2007: p. 205.
8. Davidson-Shivers, G. V, & Tanner, E. J. (2001). How do Students Participate in Synchronous and Asynchronous Online Discussions? *J. Educational Computing Research* *25*(4), 351–366.
9. Piburn and Middleton, as referenced by Davidson-Shivers, G.V, & Tanner, E.J. (2001). How Do Students Participate in Synchronous/Asynchronous Online Discussions? *J. Educational Computing Research* *25*(4), 351–366.
10. Jeong as referenced by Davidson-Shivers, G. V, & Tanner, E. J. (2001). How Do Students Participate in Synchronous and Asynchronous Online Discussions? *J. Educational Computing Research* *25*(4), 351–366.
11. Swan 2002 as referenced by Drouin, M. A. (2008). The Relationship Between Students' Perceived Sense of Community and Satisfaction, Achievement and Retention in an Online Course, *The Quarterly Review of Distance Education*, *9*(260), 267–284.
12. Woods 2002 as referenced by Drouin, M. A. (2008). The Relationship Between Students' Perceived Sense of Community and Satisfaction, Achievement and Retention in an Online Course. *The Quarterly Review of Distance Education*, *9*(260), 267–284.
13. Reeves, J. (2013) Enhancing Student Learning in Online and On-Site Courses in Circuits and Electronics. webinar at <http://us.ni.com/webcasts/engineering-education>
14. Reeves, J., Sinha, B., Davis, A., Amin, M. (2013) Innovations in Remote Laboratories/Simulation Software for Online/On-Site Engineering Students. *ASEE Annual Conference*, Atlanta, GA, 23-26 June 2013 #6793.
15. Chen, D. (2006) 7 Things You Should Know About Google Jockeying. *EDUCAUSE* Retrieved on 1/30/2014 from <http://www.educause.edu/library/resources/7-things-you-should-know-about-google-jockeying>

## Teaching Pattern Recognition: A Multidisciplinary Experience

Shadnaz Asgari and Burkhard Englert  
California State University, Long Beach

### Abstract

The solution to many open problems in science and engineering requires approaches that are multidisciplinary in nature. Therefore, state-of-the-art education needs to prepare prospective scientists and engineers to not only explore the boundaries within their own disciplines, but to also understand the basics of other disciplines. Accomplishing this important mission requires careful planning, selection of appropriate topics, and development of realistic educational objectives to promote cooperation and integration between students with various backgrounds.

Aiming for such a goal, in the spring of 2013, a graduate level course on “pattern recognition” was piloted in the Computer Engineering and Computer Science department of California State University, Long Beach. The course was offered under the name “CECS 590-Special Topics in Computer Science” and several graduate students from various backgrounds (Biology, Mathematics and Computer Science) were enrolled. Throughout the semester, students learned about different machine learning techniques and algorithms, and implemented multidisciplinary projects which required the application of those methods in order to solve real-world problems in biomedical science.

In this paper we present the results of our pilot offering. We provide details about the course objectives, structure, assessment tools and outcomes. We also discuss some of the challenges confronted in teaching such a multidisciplinary class and the approaches undertaken to address those issues. Hence, the presented results of our pilot offering could be of value to other multidisciplinary educators.

### Introduction

In the era of global competition to create innovative value, multidisciplinary collaboration has become an essential element for the successful delivery of a product. Hence, employment of multidisciplinary teams; consisting of members with different professional backgrounds working together towards a common goal, has become an industry trend<sup>1</sup>. This recently adopted trajectory accurately reflects the realities of the twenty-first-century: any sustainable solution to the problems humanity is currently facing requires an integrated and interactive mix of sciences, engineering, social sciences, and humanities<sup>2</sup>. As a result, modern education needs to prepare future scientists and engineers to not only explore the boundaries within their own disciplines, but to also understand the basics of other fields.

The Accreditation Board of Engineering and Technology (ABET) acknowledges the importance of multidisciplinary education and explicitly supports it<sup>3</sup>. In fact, the 2013-2014 criteria for accrediting Engineering programs requires the programs to insure that prospective engineers hold "an ability to function on multi-disciplinary teams"<sup>4</sup>. One plausible approach to accomplish this mission is through the curricular concept of integrating or connecting school subject areas. The integrative or multidisciplinary curricular approach related to technology education seeks to help students learn and appreciate the relevancy of how school subjects are tied together and how each subject builds on the other<sup>5</sup>. This can be achieved by designing multi-disciplinary courses where students are exposed to

selected key theories and techniques of various scientific disciplines that are jointly applied to a field of study or professional practice.

Although the importance of multi-disciplinary education is well acknowledged and its integration into traditional education is often sought, significant barriers exist for the execution of supporting activities. Examples of such impediments may include increases in teaching loads, curricular restrictions, the need to attract course participants from outside the sponsoring department, the need for the course instructor to possess some level of expertise in more than one field of study, the difficulty of instructing a heterogeneous student body, prejudice and time constraints<sup>3,6,7</sup>. The administrative and cultural barriers to multidisciplinary education can be ameliorated with proper planning, while the instructional barriers can be addressed through careful selection of appropriate topics, and development of realistic educational objectives that promote cooperation and integration among students with various backgrounds. A pilot offering of a multidisciplinary course provides an excellent opportunity to identify additional relevant challenges and find appropriate resolutions to address those issues.

The current paper presents the result of such a pilot offering at Computer Engineering and Computer Science Department of California State University, Long Beach (CSULB). In the spring 2013 semester, a graduate level course on “pattern recognition” was offered under the name “CECS 590-Special Topics in Computer Science” and several graduate students from various backgrounds were enrolled. Over the semester, students learned about different machine learning techniques and algorithms, and implemented data analysis projects with an emphasis on biomedical applications. The rest of this paper is organized as follows. In Section 2 we discuss the details of the course offering including course objectives, structure and assessment tools. Section 3 discusses our pilot evaluation and its results. Finally, in Section 4 we conclude the paper with a brief summary of confronted challenges and the approaches undertaken to address them.

### **Teaching Pattern Recognition**

Pattern Recognition is a branch of machine learning, one of the fastest growing multidisciplinary fields at the intersection of computer science and mathematics, and concerns the construction and study of systems that can learn from data. A core objective of a learner is to generalize knowledge gained from the experience<sup>8</sup>. Generalization in this context is the ability of a learning machine to perform correctly on new, unseen data samples or tasks<sup>9</sup>. For example, a pattern recognition system could be trained on email messages to learn distinguishing between spam and non-spam messages. After learning, it can then be used to classify new email messages into spam and non-spam folders<sup>10</sup>. Pattern Recognition has a broad range of applications spanning from computational neuroscience and medical diagnosis to stock market analysis and consumer behavior prediction.

A major objective of biomedical pattern recognition is discovering the patterns in the biomedical data that are associated with the onset and/or prognosis of a specific disease (identification of biomarkers). As the size, complexity, and variety of data sets resulting from biomedical research continue to increase at an exponential rate, so does the need to educate future biomedical scientists and engineers to learn about sophisticated algorithms and techniques which could be applied to automatically identify the biomarkers. In response to this need, we piloted a 3-unit graduate level course on “pattern recognition” with emphasis on biomedical applications. In what follows, we provide a detailed description of the organization of the course.

*Course objectives, pre-requisites and textbooks.* For our “Pattern Recognition” class, the course objectives were defined as

- To understand and apply methods for preprocessing, feature extraction, and feature selection to multivariate data.
- To develop prototype pattern recognition algorithms that can be used to study algorithm behavior and performance against real-world multivariate data.

The course pre-requisites were set as

- Basic familiarity with probability and statistics
- Basic familiarity with linear algebra
- Basic familiarity with computer programming

No textbook was mandated, as the instructor planned to cover different topics from different sources. But the following books were recommended:

- R. Duda, P. Hart, D. Stork, "Pattern Classification", second edition, 2000.
- T. Hastie, R. Tibshurani, and J.H. Friedman, "The Elements of Statistical Learning: Data Mining, Inference, and Prediction", Springer Series in Statistics, 2001.

*Recruitment of a heterogeneous student body.* To recruit a diverse body of students, in addition to the Computer Science department, the course offering was advertised in the Mathematics department and the Biology department by sending a prepared course flyer to the Mathematics and Biology faculty members who were involved in multidisciplinary research and by asking them to share it with the potentially interested students. The CECS 590 course requires instructor consent for registration. Based on the pre-requisite requirements, the instructor (first author) authorized the registration of seven students (four students from computer science, two students from mathematics and one student from biology) and the auditing of another student (from biology).

*Course topics.* Aiming at balancing theory and practice, the instructor covered the mathematical as well as the heuristic aspects of various pattern recognition techniques and algorithms throughout the semester. The topics covered in the course were:

- Decision Theory (Likelihood Ratio, Naïve Bayes Classification, Belief Networks)
- Maximum-Likelihood and Bayesian Parameter Estimation
- Dimension Reduction (Principal Component Analysis, Linear Discriminant Analysis)
- Dynamic Bayesian Network (Hidden Markov Model)
- Nonparametric Techniques (Probabilistic Neural Network, Nearest Neighbor Classification)
- Linear Discriminant Functions (Perceptron, Linear Programming)

*Course learning assessment.* Homework was designed for each topic to insure that the students learn the theory. Quizzes were taken every three weeks to assess the students’ learning of the materials throughout the semester. Our course had one paper-and pencil midterm and a final exam. The exams consisted of a variety of questions requiring employment of algorithms covered in the course to solve a problem. In addition, 3 programming projects with Matlab implementation were assigned to exemplify the concepts. Most of the programming assignments were real-world problems in biomedical science and mainly pertaining to the instructor’s previous or ongoing research projects in the area of

Computational Physiology. The most comprehensive programming assignment was assigned during the last few weeks of the class and required employment of various methods that students had learned throughout the semester. The goal of the project was the design of an efficient (in terms of computational complexity) and accurate (in terms of the algorithm's sensitivity and specificity) method which automatically distinguishes valid physiological pulsatile signals from the ones contaminated with noise and artifacts. As noise is a constantly existing problem in any application that involves information extraction from clinical recordings of physiological signals, designing an accurate and efficient method to address this issue is of significant practical value to the clinicians<sup>11</sup>. For the project, the students were asked to apply different dimensionality reduction methods (e.g. Principal Component Analysis, Linear Discriminant Analysis) to a dataset of more than 14,000 arterial blood pressure pulses and compare the results of valid pulse recognition using different classification techniques (e.g. parametric Bayesian, probabilistic neural network, nearest neighbor).

### Evaluating the Efficacy of Teaching

To assess the efficacy of teaching, we use two different measures: students' grades; and students' teaching evaluation results. Figure 1 shows the boxplots of students' grades (normalized to 100) for various exams in the chronological order taken throughout the semester. As the magenta dashed line on the plot shows, average student grades improved over the semester. This observation can be explained as follows: One of the main challenges of teaching a multidisciplinary class with a heterogeneous student body is that the prior experiences and knowledge of the students with respect to the subject of the course are not aligned. For our pattern recognition class, although all the students had (at least) basic familiarity with probability and statistics, and linear algebra, some of them had taken the pre-requisite courses more than one year before the class when they were undergraduate students. These students had more difficulty at the beginning of the semester and needed additional assistance to catch up with the rest of the class. To address this issue, the instructor asked the students to actively attend office hours when more time could be spent on reviewing the pre-requisites and/or any other topic which the students had difficulty to understand. In addition, the instructor made extensive efforts during the first few weeks of the class to adapt and/or adjust course content, teaching techniques and learning activities to align interests, knowledge and foci of students. We believe that these efforts have contributed to the gradual improvement of the performance of the class throughout the semester.

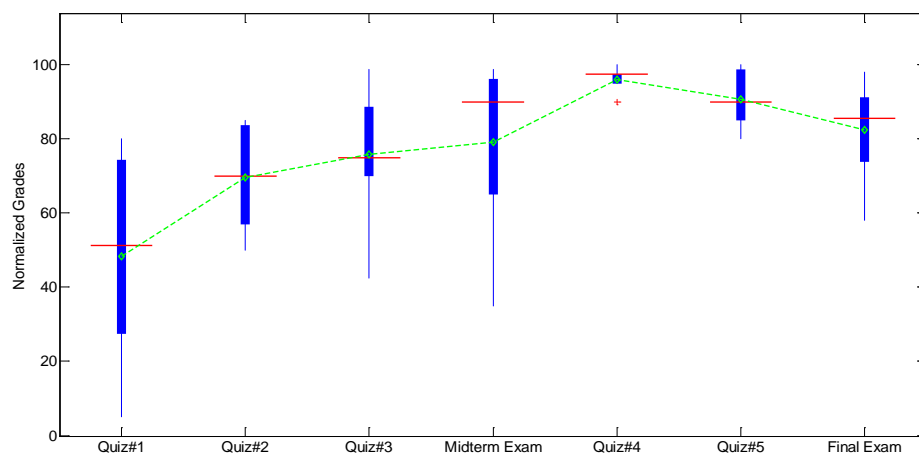

Figure 1. Box plot of students' normalized grades for various exams. The magenta dashed line connects the average grade of different exams

Figure 2 presents the boxplot of the student's grades for three computer programming assignments. Similarly we observe that throughout the semester programming performance of the class improved. Although all the students had basic familiarity with programming, some of them had not implemented any project in Matlab before. Hence, the first computer assignment was challenging for them. Given this observation, the instructor tried to address this issue by providing additional assistance outside of the class and also through email communication with the students. She also defined a simple bonus project before the second assignment to provide an additional opportunity for the students to improve their Matlab programming skills before the second computer assignment. Furthermore, she allowed the students to work in groups of two for the remaining two assignments. These modifications could have contributed to the improvement of the class performance in computer programming.

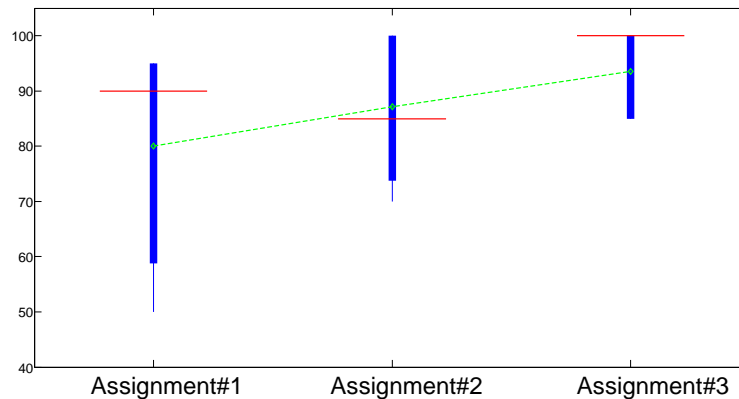

Figure 2. Box plot of students' normalized grades for programming assignments. The magenta dashed line connects the average grade of different assignments

Figure 3 shows the distribution of the final course grades. To calculate the final course grade, the lowest quiz score was not considered, and each remaining quiz accounted for 6% of the final grade. The midterm and final exam had 20% and 26% weight, respectively. Programming assignments accounted for 20% and class attendance for 10% of the total grade. As seen from figure 3, 43% of students received a score of over 90 (an "A"), while 29% of the students received a score in the range of 80-90 (a "B"). Therefore, a total of 72% of the students in the class displayed good or excellent performance in learning the course materials.

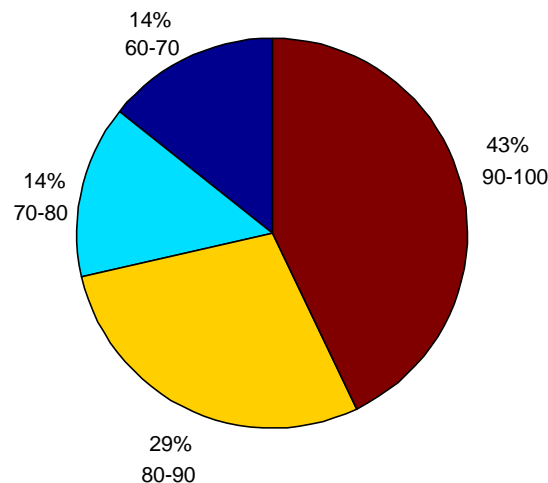



Figure 3. Distribution of course final grades normalized to 100

As a second measure for assessment of teaching efficacy, we exploit the results of CSULB’s Student Perception of Teaching (SPOT) survey conducted on the last day of instruction. This anonymous survey consists of 9 multiple-choice and 3 open-ended questions as shown in Table 1. The possible answers for the multiple-choice questions are: 1: strongly disagree; 2: moderately disagree; 3: slightly disagree; 4: slightly agree; 5: moderately agree; and 6: strongly agree.

Table 1. Multiple-choice and open-ended questions of SPOT survey.

Multiple-Choice Questions
Class Time was used efficiently.
Concepts were presented in a manner that helped me learn.
Assignments contributed to my learning.
The instructor responded respectfully to student questions and viewpoints.
The instructor was effective at teaching the subject matter in this course.
The instructor communicates well.
Graded assignments were returned promptly.
The grading criteria for this course were clearly defined.
The instructor was available during the office hours.
Open-Ended Questions
What contributed most to your learning in this course?
Did anything interfere with your learning in this course?
What suggestions or recommendations do you think would help your instructor prepare to teach this course again?

Figure 4 shows the results of students’ responses to the multiple-choice questions. The comments that students made in response to open-ended questions are summarized in the Appendix.

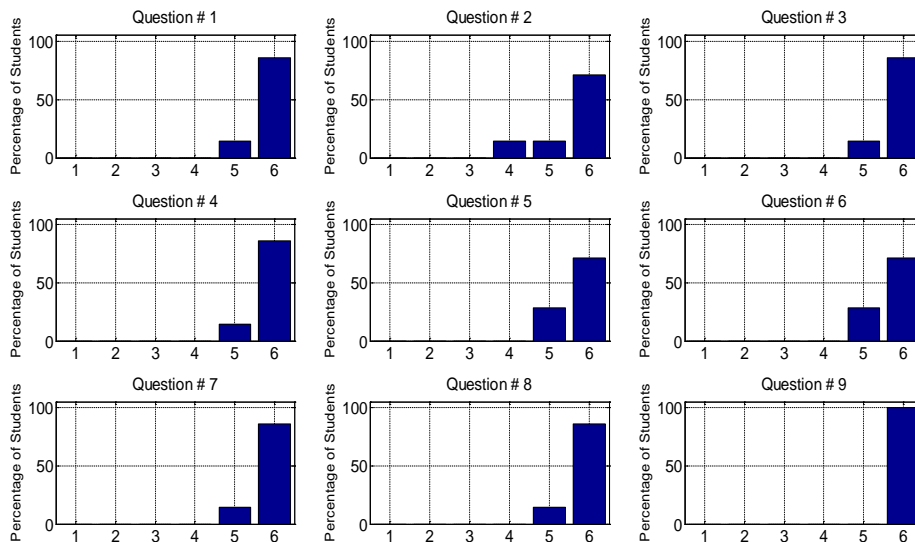

Figure 4. Student responses to the multiple-choice questions of the CSULB SPOT survey

From Figure 4 we observe that at least 70% of the students strongly agreed with all the statements of the SPOT survey. More specifically, about 85% of the students strongly agreed that the class time was used

efficiently (question #1). As mentioned earlier, our “pattern recognition” class was offered as a standard computer science course named “CECS 590-Special Topics in Computer Science”. This course has only 2.5 hours contact hours per week without any lab session. Hence, the instructor of “pattern recognition” had to carefully plan the course flow and manage the limited class time to cover both the theory and the computer programming aspect of each technique. For example, there was one topic (decision trees) that the instructor had originally planned to cover, but due to time constraints at the end of the semester, she decided to skip that topic and not compromise the quality of teaching with the quantity of the materials covered. Overall, as evidenced by student responses to question #1, the instructor’s efforts to efficiently manage the limited class time have been effective.

For question #2, about 70% of the students strongly agreed that the concepts were presented in a manner that helped them understand, while 15% of them moderately agreed and the remaining 15% slightly agreed with this statement. This variability in the students’ responses could be explained by the fact that achieving a single teaching approach which optimally works for every student in a heterogenous class is almost inconceivable. In our class, the students came from three different majors: computer science, mathematics and biology. While students majoring in mathematics may be more interested in learning the theoretical aspect of a technique, computer science or biology students would require a teaching approach mainly emphasizing the heuristic aspects of the discussed techniques. Therefore, keeping the perfect balance between theory and practice in such a multidisciplinary class can be really challenging.

About 85% of the students strongly agreed that the given course assignments have helped them in the enhancement of their learning experience (question #3). We believe that this success in delivering the learning objective grew out of the use of real-world examples and projects from biomedical science. Students’ comments (See Appendix) do substantiate this theory, as well. We also believe that assigning a comprehensive project at the end of the semester which required the application of different techniques learned throughout the semester could have concluded our efforts to enhance students learning.

To complete the evaluation of teaching efficacy for our “Pattern Recognition” class, we studied the students’ response to the remaining multiple-choice questions of SPOT: About 85% of the students strongly agreed with the statements of questions # 4, 7 and 8, while all the students strongly agreed with the statement of question #9. About 70% of the students strongly agreed and 30% of students moderately agreed that the course teaching has been effective (question #5).

## **Conclusion**

As it is expected for teaching any multidisciplinary class, instructing “pattern recognition” to a group of students with various backgrounds was challenging. Although the group of participating students was carefully selected, fairly early in the course, we realized that the knowledge, experience and foci of students were not aligned. While students majoring in mathematics had a solid theoretical foundation for learning the concepts, they needed additional assistance (specially at the beginning of the semester) with respect to implementation of computer programming assignments. There were also few computer science and biology students who had no prior Matlab coding experience. Hence, these students experienced some difficulties with programming assignments, as well. As CECS 590 had no associated lab, we tried to address this issue by providing additional assistance outside of the class and also through email communications with the students. Furthermore, we defined a simple bonus project that helped the students to increase their programming skills.

For a few students the lack of sufficient knowledge in probability and statistics was another hindering factor. Leveraging on the additional contact time provided during office hours, the instructor assisted those students to catch up with the rest of the class by reviewing the related pre-requisite materials and answering their questions in details. The use of real-world examples or projects related to biomedical science substantially enhanced students' learning, as evidenced by their comments. Hence, the result of our teaching experience is in agreement with the accepted belief that project-based learning can be an efficient teaching approach for multidisciplinary classes. We also learned that in order to further enhance the learning experience in a multidisciplinary class, the instructor needs to have a careful but flexible plan in terms of course content, teaching techniques and learning activities which allows for continuous adjustments of strategies depending on the class dynamics or educational needs of the students. Although the inclusion of some level of flexibility in teaching of any course is necessary, the need for adaptive teaching is more significant in a multidisciplinary class, because alignment of interests, knowledge and foci of a heterogeneous student body requires more considerable effort.

In summary, our pilot offering of "Pattern Recognition" has been a challenging but rewarding experience. As our next step, we plan to leverage on our current experience in teaching such multidisciplinary class and develop and offer a course on "Applied Data Analysis" which is tailored for a heterogeneous Engineering student body.

### **Bibliography**

1. Joachim S, Petra BS. Thinking in design teams-an analysis of team communication. *Design Studies* 2002;23:473-96.
2. Williams R. The Challenge of Multidisciplinary Education for Undergraduates. *MIT Faculty NewsLetter* 2007;19.
3. Hendrickson CT. Encouraging Multi-Disciplinary Education and Inter-disciplinary Research. *Third National Congress on Civil Engineering Education*; 2001; Houston, Texas: American Society of Civil Engineers. p. 1-5.
4. Accrediation Board for Engineering and Technology (ABET). *Retrieved on March 3, 2014 at <http://www.abet.org/>*.
5. Wicklein RC, Schell JW. Case Studies of Multidisciplinary Approaches to Integrating Mathematics, Science and Technology Education *Technology Education* 1995;6.
6. Dekhtyar A, Goodman AL, Montana A. Teaching Bioinformatics in Concert: an Interdisciplinary Collaborative Project-based Experience. *2013 American Society for Engineering Education Pacific Southwest Conference*; 2013; Riverside: American Society of Engineering Education. p. 147-68.
7. Tang HH, Hsiao E. The advantages and disadvantages of multidisciplinary collaboration in design education. *5th International Congress of International Association of Societies of Design Research (IASDR)*. Tokyo, Japan.2013:1-10.
8. Bishop CM. *Pattern Recognition and Machine Learning (Information Science and Statistics)*: Springer-Verlag New York, Inc.; 2006.
9. Mohri M, Rostamizadeh A, Talwalkar A. *Foundations of Machine Learning*: The MIT Press; 2012.
10. Maldonado S, L'Huillier G. SVM-Based Feature Selection and Classification for Email Filtering. In: Latorre Carmona P, Sánchez JS, Fred ALN, eds. *Pattern Recognition - Applications and Methods*: Springer Berlin Heidelberg; 2013:135-48.
11. Asgari S, Bergsneider M, Hu X. A robust approach toward recognizing valid arterial-blood-pressure pulses. *IEEE transactions on information technology in biomedicine : a publication of the IEEE Engineering in Medicine and Biology Society* 2010;14:166-72.

### **Appendix**

Here we include the students' responses to open-ended questions of the course SOPT survey. Please note that not all students answered these questions.

**Question:** What contributed most to your learning in this course?

"Good execution of real-world examples and real-world projects."

"All the applicable methods that are useful for classification."

“Lectures that were presented clearly.”

“The examples in class and the programming assignments.”

“Lecture and quizzes were the most helpful. Programming exercises were insightful, but also very tedious at times and didn’t help that much.”

“The assignments that we had. Instructor tried to make sure that all students understand the materials.”

“Examples and problems in class.”

**Question:** Did anything interfere with your learning in this course?

“None.”

“None.”

“None.”

“Lacking mathematical foundation necessary for the course.”

“The programming assignments. It was hard to know if my code was correct or wrong, or what might have gone wrong.”

**Question:** What suggestions or recommendations do you think would help your instructor prepare to teach this course again?

“Maybe more homework and projects.”

“I sometimes felt that it was hard to both keep up with the concepts that were being explained while taking notes at the same time. Perhaps notes can be written a little more sparingly and concepts can be elaborated on a little bit more from time to time before moving to the next part of a lecture.”

“I think the homeworks were great, I really liked the class and I learned a lot.”

“Maybe have some “example” data we could test our code on w/ associated “example” answers to see if it was working correctly.”

## Research and Projects-Based Courses to Validate Practical Engineering Solution Techniques

Jeff Ashworth and Will Quinn  
Embry-Riddle Aeronautical University, Prescott Campus

### Abstract

Many courses in engineering education are based on teaching the undergraduate student how to solve engineering problems without including the knowledge of what they are solving or why they are using a particular technique. Professors sometimes propose a computer solution or technique the student does not understand; therefore, the student cannot evaluate the accuracy of the results. Without knowledge of the boundary conditions or required assumptions, the student will not fully comprehend or be able to apply the technique to real world problems after graduation. Many of the major university engineering programs familiar to the authors have reduced the student design experience from an entire vehicle to only designing a small component of the overall product. The students may then use one solution routine for the component without having knowledge of the “best” solution for the entire product. Without being exposed to a variety of solution techniques and product integration, the student may not choose an appropriate solution. Instructors in these programs are giving the students the how, without instilling the knowledge of what or why.

To connect the how, what, and why of engineering problem solution, a three-course series of practical aircraft performance and design has been developed. Each course is one semester in duration and must be accomplished in sequence to meet maximum student learning objectives. The first course establishes practical aerodynamic and aircraft performance knowledge that fills the student toolbox with the basic techniques to analyze aircraft parameters across a wide range of operating conditions. The next two courses make up the senior capstone aircraft design sequence. In the preliminary design course, the students are given aircraft performance specifications and must utilize current design methodology to completely design an aircraft. In the detail design course to follow, the same students take the aircraft design and begin the Research, Development, Test, and Evaluation (RDT&E) process. A model of the aircraft is tested in the wind tunnel, modified, and re-tested to verify the effectiveness of the proposed changes. Feedback from students and industry evaluators overwhelmingly support this aircraft research and projects-based process for enhanced student comprehension and retention.

### Introduction

The students in the three-course sequence gain valuable experience by working in groups both small (2 to 3) in the first course and larger (6 to 8) in the capstone courses. The larger groups are task oriented and perform much like the industry model of Integrated Product Teams (IPTs). These industry IPTs are single teams, split into sub-groups, to design individual components that come together to form cohesive products. All major aircraft companies assign significant design tasks to IPTs for projects ranging from conceptual design to fabrication. Each phase of the courses is treated like an industry milestone and requires a formal report, presentation, or both. The final presentation in each of the two design courses is evaluated only by a team of experts from industry and critiqued based upon a specific set of evaluation metrics. Therefore, the success of the process is documented each semester by industry representatives from outside sources, such as Air Force Flight Test Center, Boeing Aerospace, Raytheon, Scaled Composites, and many others.

The initial course in the sequence is titled Aircraft Flight Mechanics and Performance (AE 395N). This course applies research and project-based techniques from numerous sources to validate practical solution methods and compare results with published data for existing aircraft. The second and third courses in the series are the aircraft preliminary and detail design capstone courses. In the Aircraft Preliminary Design (AE 420) course, the students work in groups of 6-8 to accomplish conceptual and preliminary design of an aircraft in response to given performance specifications. On larger aircraft designs, a Mechanical Engineering Propulsion Group is integrated into the process to complete capstone design requirements and design the engine for the aircraft. In the Aircraft Detail Design (AE 421) course, the same group continues with its aircraft design into the RDT&E process by building and testing a wind tunnel model. After initial testing, the group recommends modifications to the model and re-tests to verify the modification effectiveness and recommend a final aircraft configuration for full-scale testing. At the end of each semester's design course, industry representatives evaluate the design presentation for valid techniques and reasonable results. Each of the three courses contains essential components for building the knowledge to understand not only the how, but also the what, and why of engineering problem solution.

### AE 395N, Aircraft Flight Mechanics and Performance

The first in the set of three research and project-based courses that teaches the students practical aeronautical engineering problem solution is titled Aircraft Flight Mechanics and Performance (AE 395N). The objective of this course is to review essential background information from previous courses such as basic aerodynamics and aircraft static stability, and to expand on practical performance techniques. The course also provides the students with an initial introduction to aircraft design concepts; therefore, this course fills the void between previous theoretical courses and practical application in the aircraft design sequence.

The AE 395N course is different from other courses in most curricula because it is a research and project-based course rather than a lecture-assignment-exam-based course.<sup>1</sup> The students work together in teams of 2-3 students and select an existing aircraft to research. The teams then apply basic aircraft parameters in order to calculate and verify the total aircraft performance. In the aerodynamics portion of the course, the teams research the airfoil that makes up the wing of their selected aircraft. Aerodynamic principles are applied to the airfoil to determine the total lifting capability of the wing. An example of a two-dimensional (2-D) airfoil to three-dimensional (3-D) wing conversion of a lift-curve is shown by Figure 1.

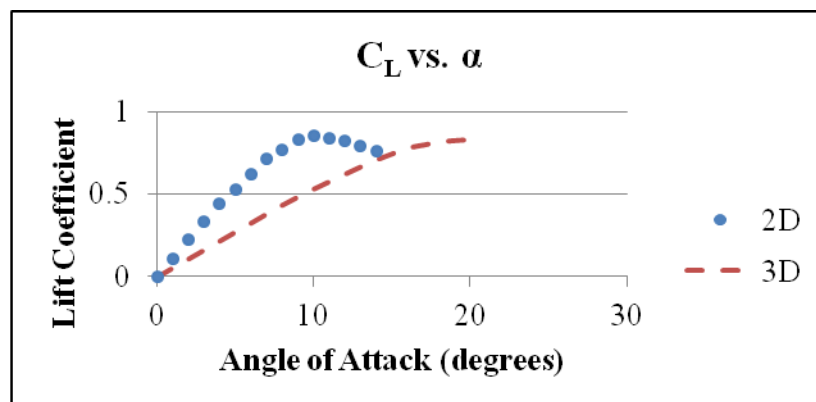

Figure 1. 2-D and 3-D lift curves.

The lift curves in Figure 1 show the difference in lift coefficient ( $C_L$ ) with varying angles of attack ( $\alpha$ ). The 2-D curve is for an airfoil that spans the entire wind tunnel test section. The 3-D curve is for an entire wing where wingtip effects are applied. Vortices at the tip of a wing have the effect of lowering the maximum lift coefficient and increasing the angle of attack where stall occurs.<sup>2,3,4</sup> A drag build-up technique, covered in the lecture/research portion of the course, is accomplished for each component of the aircraft.<sup>2,4</sup> The calculated drag along with researched aircraft engine data predict the overall velocity performance capability of the aircraft. The drag produced by the aircraft is equal to the thrust required ( $T_R$ ) to maintain airspeed at a given altitude.  $T_R$  and thrust available ( $T_A$ ) are plotted to determine the aircraft performance at a flight altitude and condition. An example of a  $T_A$  and  $T_R$  plot is depicted in Figure 2. The difference between the  $T_A$  and  $T_R$  curves indicates the aircraft's ability to change energy state (climb or accelerate) from its current flight condition.<sup>2,5</sup> The close correlation between the calculated (AE 395N) and published (Actual) curves indicates the validity of the process used by the students.

In the final phase of the course, an analysis of the static stability derivatives is conducted to determine the aircraft response to perturbations.<sup>2,3</sup> This analysis familiarizes the students with aircraft static stability requirements that are encountered in the aircraft design process. By presenting the students with projects that allow them to apply practical engineering techniques to existing aircraft, the students are able to gain an understanding of the design aspects that must be considered when creating a new airplane. This course leads the students through the why and how some theory can be applied to the real-life design of an entire aircraft. By the end of the AE 395N course, the students are prepared to use their knowledge to design an aircraft in the first design course. This preparation for the follow-on courses is a vital outcome from the course.

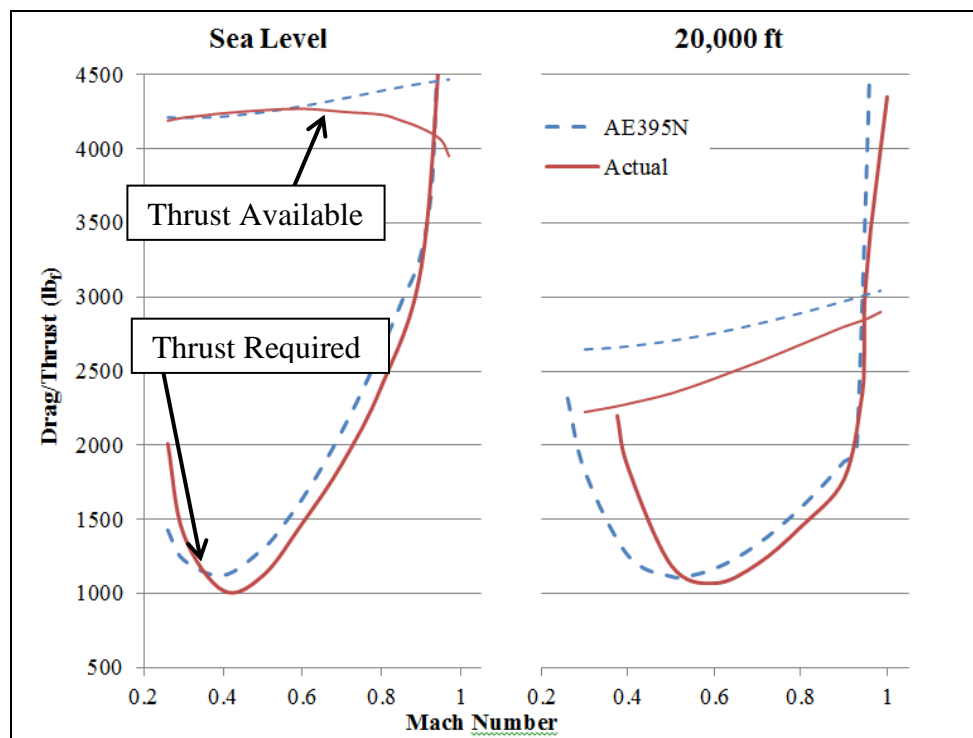

Figure 2. Thrust available and thrust required.<sup>1</sup>

### **AE 420, Aircraft Preliminary Design**

Aircraft Preliminary Design (AE 420) is the first part of the aeronautical engineering capstone course sequence. During this course, the students work in 6-8 member teams to design an entire aircraft to meet the performance requirements specified in a Request for Proposal (RFP) or Code of Federal Regulations (CFR). An RFP invites industry to submit a proposal to compete in the design process. The students must utilize all the knowledge they have learned in the engineering curriculum along with the design methods learned in the AE 395N course. The objective of this course is to give the students the opportunity to utilize their knowledge to design an entire aircraft when given nothing more than performance specifications. This course also teaches students how to work together in a group as they would in an IPT. On occasion, aircraft preliminary design teams must work alongside mechanical engineering preliminary design teams in order to produce a cohesive aircraft and powerplant design.

The students are presented with many RFP's for different types of aircraft such as remotely piloted vehicles, general aviation aircraft, heavy-lift aircraft, fighter aircraft, and space launch-vehicles. These RFP's dictate the mission specifications and objectives to be met by the aircraft they choose to design. The course is divided into four phases, and reports and presentations of each phase are evaluated to determine if the project should proceed to the next phase.

The first phase in the preliminary design process is to research similar air vehicles. The teams research existing aircraft that have similar missions to the selected RFP. The teams then determine a design space for their aircraft based upon assumptions or constraints of the RFP and CFR. Determination of the design point allows the teams to begin initial sizing of the aircraft based upon takeoff thrust to weight ratio  $(T/W)_{TO}$ , takeoff wing loading  $(W/S)_{TO}$ , stall speeds in different configurations, and certain regulations from the CFR or Military Specifications (MIL-SPECS). This process of researching similar aircraft and determining a design point gives the teams a basis upon which to begin to calculate essential design parameters.<sup>6</sup>

The critical design parameter to be determined in the second phase is the take-off gross weight of the aircraft. Once the take-off gross weight is determined, the specific flight conditions can be predicted. An airfoil selection can be made based upon how much lift is needed using knowledge from the previous course (AE 395N) and wing geometry. The fuselage is fashioned based upon the mission requirements, and the wing and empennage surfaces are designed based upon the static stability requirements of the aircraft.

A drag component build-up method learned in AE 395N is performed for the aircraft in the third phase.<sup>2</sup> This drag build-up allows the team to determine what powerplant is sufficient to meet the demands of the design specifications. Thrust data from the engines are compared with drag data from the aircraft design to determine the performance characteristics of the aircraft.<sup>1,2</sup> During the fourth phase of the preliminary design process, the details of the aircraft design are completed, and any shortcomings in the preliminary design that the team detects are addressed. Finally, the design is iterated until it meets the design and static stability requirements. In the final presentation, the teams defend their preliminary design to a panel of industry engineers who give a full critique. By the end of the AE 420 course, the students have used their knowledge to produce an entire aircraft design to meet performance specifications. The illustration in Figure 3 depicts a specific excess power ( $P_s$ ) plot for the preliminary design of a heavy-lift aircraft. Specific excess power defines the performance of an aircraft and is a



function of the difference between the power available and power required at a certain airspeed and altitude divided by the weight. Specific excess power defines the energy capabilities of an aircraft.<sup>5</sup>

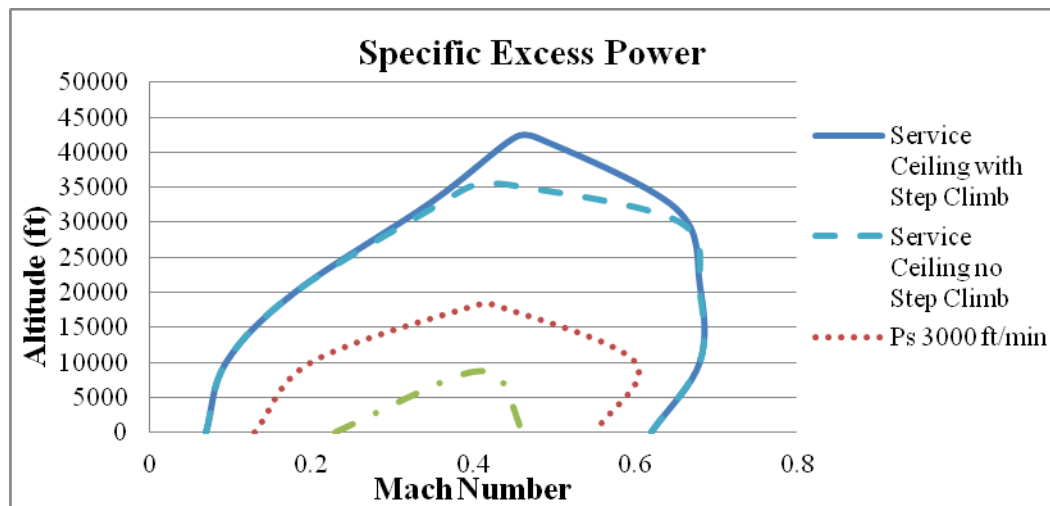

Figure 3. Specific excess power plot.

Figure 4 depicts the preliminary design of the aircraft represented in the data in Figure 3 at the end of the final phase of AE 420 last year. The students also learn team dynamics and how to work in large integrated product teams, as well as to manage individual schedules to meet design deadlines.

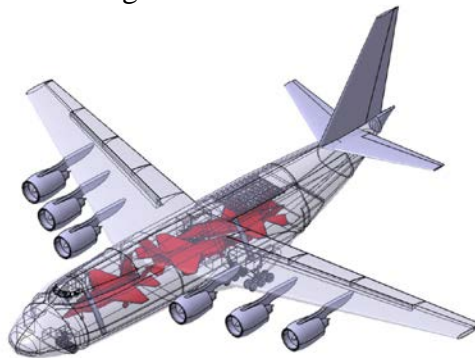

Figure 4. Preliminary design of an aircraft.

### AE 421, Aircraft Detail Design

The Aircraft Detail Design (AE 421) course follows the AE 420 course in the next semester. The student teams and the aircraft design continue throughout the two semesters. The detail design process mirrors industry practices and begins the RDT&E process. This process involves the test and evaluation of the aircraft previously designed in the AE 420 course. The objective of the AE 421 course is to allow teams to evaluate and modify the aircraft design based upon test data. The process involves building a model of the preliminary aircraft design, testing, evaluating, and improving upon the original design in order to produce the best aircraft possible. The first phase of the detail design process involves designing the wind tunnel model and writing a test plan that will result in an accurate assessment of the quality of the preliminary design. The preliminary design of the aircraft must be scaled to account for the wind tunnel size and wind tunnel balance constraints.<sup>7</sup> The majority of the model structure is printed with a 3-D printer using CATIA, and the internal support structure is designed to give the model

strength and to allow the model to be mounted to testing equipment. A CATIA drawing of a scaled model from last semester with internal structure is depicted in Figure 5. When the model design is complete, dimensioned drawings of each component are created so that the model may be fabricated.

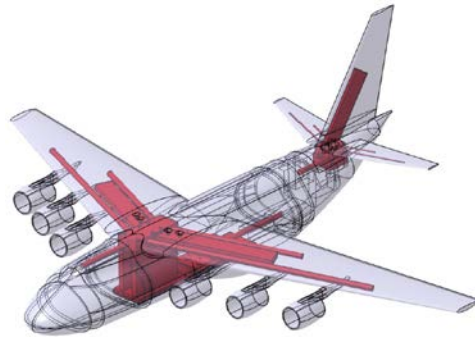

Figure 5. Scaled model with internal structure.

The parts of the model are printed, fabricated, and assembled during the second phase of the detail design process. Once the model has been constructed, the wind tunnel test plan is performed. A completed model is shown in Figure 6.



Figure 6. Completed wind tunnel model.

The data from the wind tunnel test allows the team to accurately assess the parameters determined from theoretical calculations during the preliminary design process. The parameters are also evaluated based on the requirements specified in AE 420. The parameters that fall short of the requirements are addressed and suggestions for a redesign are proposed. Figure 7 shows a comparison between the theoretical lift curves that were calculated in AE 420 (Theory) and the actual lift curves that were produced during initial wind tunnel testing (Entire A/C).

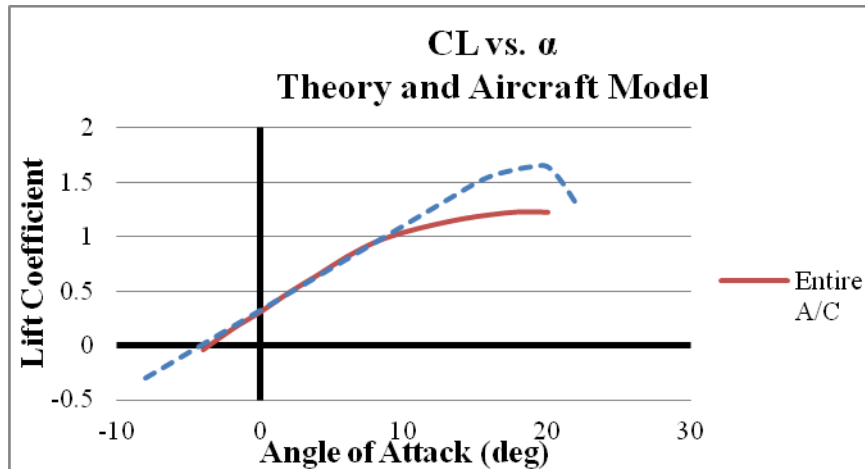

Figure 7. Lift curve comparison.

The lift curves in Figure 7 show close correlation at angles of attack between -5 and 10 degrees; however, the maximum lift coefficients of the model and theoretical data vary significantly. Therefore, the team made recommendations to the design that increased the maximum lift coefficient of the aircraft. In the third phase, the most viable options for redesign are selected and the model is modified. The model is then re-tested to determine the performance effects of the modifications. The team evaluates the total effects of all design changes and makes final suggestions for alterations to the design before recommending the best design to go to the flight test portion of RDT&E. The teams then defend the final design of the aircraft to a panel of industry professionals and receive a full critique.

By the end of the AE 421 course, the students have learned how to develop test plans to adequately evaluate critical parameters of their design. The students learn how to develop a model that is designed and scaled to work in conjunction with testing equipment. Also, the students have learned to compare the wind tunnel data to full-scale aircraft data and propose changes based upon the results of testing. Finally, in the two design courses, the students learn team dynamics by mid-semester, instructor-led, team evaluations where each student submits a written statement of how the team is functioning, and provides suggestions for improvement for the remainder of the semester. The students also submit peer evaluations at mid-semester and at semester's end of the efforts of all team members. This provides group feedback and documented team dynamics performance metrics that are tabulated and reported each semester.

### Conclusions and Recommendations

Applying basic concepts to an aircraft the students are interested in motivates them to learn more, quicker, and retain knowledge better. At the end of each semester's design course, a panel of industry representatives evaluates the design presentation for valid techniques and reasonable results. Three questions on the industry evaluation sheet for the capstone design courses are documented for university annual reports and ABET outcomes assessment. The evaluation metric scale is from 1 to 5 (5 is best) and is based on three criteria: realistic constraints, appropriate methodology, and team skills. The average score for all three criteria over the last five years has always been above a 4 (80%), and is usually above 4.3 (86%). The industry panel evaluations, student end-of-course critiques, and peer evaluations provide the assessment of the technique. These metrics have been extremely positive in validating student knowledge and preparation for success after graduation. This three-course series of practical research and projects-based verification of connecting the how, what, and why could be

applied to any engineering discipline. The reinforcement of practical engineering techniques improves student understanding, retention, and motivation for success.

Often, in the current high speed environment, our students are assumed to be completely comfortable with the basics, so course time is spent teaching advanced techniques or processes. Students may not fully understand these techniques nor really ever have the opportunity to use them. If students have the basic knowledge required by their discipline, there is no problem adapting to whatever specific environment is encountered in initial job tasks as an entry-level engineer. If new graduates have specifics without the basics, it will be difficult to adapt unless the initial tasks are identical to their educational environment. So, to motivate students and give them the best background possible, professors should teach the basics through a team, projects-based delivery and then compare to real world systems.

The student co-author and co-presenter has the experience of being one of the first to complete this three-course sequence. It is recommended by the authors that engineering programs adopt some scale of practical, research and project-based program and evaluate the progress and student success compared to a more purely theoretical approach. Increased student enrollments, retention, and job placement have, and may continue to be a result.

## **Bibliography**

1. Ashworth, J. C., Shaghoury, S. (2013). *Practical Lecture, Research, and Projects Based Engineering Education*. ASEE, 2013.
2. Raymer, D. P. (1999). *Aircraft Design: A Conceptual Approach* (3rd ed.). Reston, VA: American Institute of Aeronautics and Astronautics.
3. Yechout, T. R. (2003). *Introduction to Aircraft Flight Mechanics*. Reston, VA, USA: AIAA.
4. Nicolai, L. M., & Carichner, G. E. (2010). *Fundamentals of Aircraft and Airship Design: Volume 1—Aircraft Design*. Reston, Virginia, USA: American Institute of Aeronautics and Astronautics.
5. Mattingly, J. D., Heiser, W. H., & Pratt, D. T. (2002). *Aircraft Engine Design, 2nd ed.* Reston, VA: American Institute of Aeronautics and Astronautics, Inc.
6. Roskam, J. (2005). *Airplane Design Part 1: Preliminary Sizing of Airplanes*. Lawrence, KS., USA. DAR Corporation.
7. Pope, A., Barlow, J. P., & Rae, W. H. (1999). *Low-Speed Wind Tunnel Testing, 3<sup>rd</sup> ed.* New York, NY, USA: Wiley, John & Sons, Inc.

## Student Learning and Engagement through First Year Programs

Selyna Perez Beverly  
California State Polytechnic University, Pomona

### Abstract

The Cal Poly Pomona first year programs are engaging diverse populations of students through facilitated faculty interaction, hands-on learning, teamwork and communication skills, and defining high yet attainable expectations for students. By focusing on a learning-centered approach, the First Year Experience course (FYE), the First Year Advising program, and the Women in Engineering Program are intentional in engaging students within the College of Engineering. The purpose of these programs is to facilitate student success in the first year and to equip students with both the skills and tools to effectively progress within their respective engineering major. All three programs have revealed increases in retention among the first year student population as well as enhanced student engagement within the engineering community.

### Introduction

Cal Poly Pomona is a medium-sized public Hispanic Serving Institution that offers multiple degree programs and is widely acknowledged for its engineering program. The engineering program at Cal Poly Pomona recruits diverse individuals from across the state of California and values student and faculty interaction thus embodying a ‘learn by doing’ philosophy. Students in the Cal Poly Pomona engineering program receive both technical and practical skills to prepare them for the engineering workforce. Small class sizes and the integration of a multitude of labs in the engineering curriculum provide for a robust experience for the student in preparation for a career as an engineer. The student-centered philosophy of the institution supports student involvement and programmatic efforts that increase student success and learning. The College of Engineering is the largest college at Cal Poly Pomona serving approximately 5,000 undergraduate and graduate students. The student population consists of a large number of first-generation, low-income, and underrepresented racial minorities. The college has placed emphasis on a student’s first year to provide students with both the skills and knowledge to be successful engineering students in the college and to increase the college’s retention rates. The three first year programs which include the Engineering First Year Experience course, the First Year Advising Program, and the Women in Engineering Program have proven effective in shaping a community of students and increasing overall student success in the College of Engineering.

### Literature Review

Student departure and lack of persistence at the university is a current critical issue in higher education<sup>1</sup>. Tinto’s Theory of College Student Departure used a longitudinal model to explain how a student’s integration or lack thereof into the academic and social systems of the university predicted student drop out<sup>2</sup>. Tinto<sup>1</sup> explained that academic systems encompassed study skills and academic environment whereas social systems involved finding a supportive social group or mentor. According to Tinto<sup>1</sup>, dropout behavior results from a student being unable to integrate into the university academically and socially. Therefore students who do not feel connected to the university through academic programs or social connections (i.e. student clubs and student activities) are more likely to have difficulty persisting at the university.

First year programs that focus on integrating students into both the academic and social systems in college play an important role in increasing student persistence in college. According to Kuh<sup>3</sup>, student success is a direct result of student engagement. Kuh<sup>4</sup> explains that student engagement results in the amount of time students invest in the educational environment around them and what institutions do to effectively engage students. Thus, both student behaviors and institutional programmatic efforts have a role in affecting student success<sup>4</sup>. Successful methods of student engagement, as described by Chickering and Gamson<sup>5</sup>, include encouragement of student and faculty contact, active learning, high expectations, facilitating cooperation amongst students, and acknowledging diverse ways of learning. Tinto<sup>6</sup> discusses commonalities between institutions that have higher retention rates. This includes the creation of a community of students, faculty and staff, having a student-centered focus, and valuing students' educational needs. Tinto<sup>6</sup> also explains how developing diverse programs to focus on integrating students into academic and social systems are the most effective practices to promote student success and overall learning. Among these programs are first year programs which have the ability to impact students in a positive way leading to both student engagement and retention.

### **First Year Experience Course (EGR 100)**

With the increase of diversity amongst current students, there is also a need for pedagogical shifts in higher education<sup>7</sup>. A majority of students that enter college are not academically prepared for the rigor of college and need instruction on the basic skills necessary to succeed<sup>7</sup>. First year experience courses provide an excellent method to impact student learning and development while providing students with the necessary tools to be successful both in their major and in college. The College of Engineering developed *EGR 100, Engineering, Society and You*, a First Year Experience course (FYE), to address retention issues within the college, to focus on strengthening students' commitment to engineering, and to better equip students with skills to be successful engineering students in the college. The class incorporates not only a lecture but a lab component as well. The lecture focuses on discussing expectations of engineering students in the college, connecting students to campus resources, increasing their college readiness skills, and introducing them to the opportunities within the engineering field. The lab requires students to work on team projects and engage in experiential learning activities enhancing teamwork and communication skills.

Preliminary data analysis from the initial cohort of students that took the course in the 2007-2008 academic year reveals that dropout rate from college was 10 percent less than those that did not take the class. Two years later, the GPA of students who took the course was 8 GPA points higher on average than those that did not take the course. Overall campus data has revealed that first year experience courses, including the College of Engineering's FYE course, affect student's GPA and retention in a positive way. Within both the lecture and the lab, student learning outcomes are assessed on a variety of projects and coursework including writing assignments about engineering and the campus community, interactions with engineering faculty, and group-level presentations. Student surveys are disseminated for both the lecture and the lab and results of both surveys consistently indicate that the learning outcomes of the course have been successfully met. Students cite time management and resources as the top skills gained specifically from the lecture. The lab survey indicates students' development of teamwork and communication skills. The Fall 2013 survey results reveal that 90 percent of students would recommend the class to other students who have not yet taken the class.

When the course was initially implemented, approximately 234 students enrolled in the course throughout the academic year. The number of students that enroll in the course has steadily increased

from 2007 to the present even though the course is not mandatory. Currently, through constant communication with first year students about the positive effects of the course before orientation, during orientation, and through the first year advising program, enrollment in the course has increased significantly. Students are encouraged to take the FYE course to fulfill a General Education requirement which has also helped boost enrollment in the course. In 2012-2013, approximately 550 students or 73% of first year engineering students enrolled in the course, which is predicted to be similar for the 2013-2014 academic year. The FYE course also incorporates teaching partners from Student Affairs to build partnerships between Engineering and Student Affairs and to bring additional areas of expertise to the course. Faculty and teaching partners are invited and encouraged to attend professional development workshops to become familiar with the goals of the course, the teaching methods used in the course, and to engage in the FYE course material to strengthen the mission of the course. Faculty that teach the course meet on a regular basis throughout the academic year to discuss the course, share best practices, plan joint activities, and give feedback regarding the course.

### **First Year Advising Program**

The changing characteristics and diverse needs of students have also affected academic advising methods within higher education. The current generation of students are technologically acute and desire quick methods of gathering information<sup>8</sup>. The characteristics of current students necessitate the development of innovative methods focused on delivery of information inclusive of curriculum, policies, procedures, and tools and skills for success. Developing an advising relationship with the student is also an important part of academic advising and adapting the relationship to fit the student's needs can be challenging. Jordan<sup>8</sup> suggests incorporating the use of technology as well as continuing to incorporate developmental advising to students so that the advisor and advisee relationship is continued. The First year Advising Program has a learning-centered approach as well as a student development approach to advising students. The overall goal of the advising program is to encourage student success and to promote student development through intrusive learning outcomes based advising. NACADA, the National Academic Advising Association, strongly believes and supports the notion that "Advising is Teaching" and critical to student success and retention. The College of Engineering First Year Advising Program developed strategic ways of providing both informational and developmental advising to more than 700 freshmen per year across all seven engineering disciplines.

Through group advising and the utilization of technology, the First Year Advising Program incorporates a developmental advising program to meet student's diverse learning styles and to increase the relationship between advisor and advisee. In the Fall and Winter Quarters, and in coordination with the Registrar's office, students receive a hold on their account that prevents them from registering for the consecutive quarter. Students are notified of the hold through email and are given two options to complete the advising requirement: a group advising session or an online video tutorial. An online registration system is set up for students to register for a group advising session. If they choose to take the online video tutorial, they are instructed to go to the University's online learning tool and are given specific directions on how to access the information. A total of twelve general group advising sessions are hosted in the Fall and Winter quarters. The online video tutorial consists of a video recorded through Adobe Presenter along with a quiz that students are instructed to complete. Upon completion, students are instructed to meet with an advisor one on one. The group advising presentations and the recorded advising video consist of an interactive power point presentation which includes the following learning outcomes, outlined in Table 1, that are consistent with the university outcomes and utilize the advising domains stipulated by the CAS Standards<sup>9</sup>.

Table 1. Learning outcomes for advising program.

<p><b>Intellectual Growth (P, T, L)</b></p> <p>Students will be able to explain campus and department policies and procedures such as withdrawal, grade forgiveness, leave of absence, and repeats.</p> <p>Students will be able to articulate campus and departmental academic policies related to academic standing.</p> <p>Students will know where to find curriculum sheet and flowchart and be able to interpret it accurately.</p> <p>Students will comprehend general education requirements and be able to explain how to find requirements using the online catalog</p>
<p><b>Personal and Educational Goals (T)</b></p> <p>Students will develop at least one short-term goal and one long-term goal.</p> <p>Students will be able to describe and identify what they like about college and discuss concerns, if any.</p>
<p><b>Realistic Self-Appraisal (P, T)</b></p> <p>Students will identify challenges and successes from a previous quarter and be able to articulate a method of overcoming the challenge.</p> <p>Students will connect engineering tips such as working hard, smart, and with a positive attitude to be successful in the College of Engineering.</p> <p>Students will conclude whether or not engineering is the right fit for them.</p>
<p><b>Clarified Values (P)</b></p> <p>Students will identify EGR 100, the First year experience engineering course, as a course that is beneficial for their success in the College of Engineering.</p> <p>Students will connect importance of getting involved on campus to success in the college and in their careers</p> <p>Students will identify passion as being an important part of the pursuit of a career in engineering.</p>
<p><b>Career Choice (T, L)</b></p> <p>Students will be able to locate Career Services and name at least one function of Career Services.</p> <p>Students will demonstrate understanding of purpose of CPU 100, Resumaniacs, and career assessment tests.</p>
<p><b>Independence (P,T,L)</b></p> <p>Students will demonstrate effective use of Bronco Direct and identify where important items are such as the unofficial transcript and degree progress report.</p> <p>Students will describe campus resources, such as the Learning Resource Center and the Maximizing Engineering Potential Program Academic Excellence Workshops, and connect them to improving success in the College of Engineering.</p> <p>Students will identify important requirements and tests necessary for the College of Engineering, such as the Math Diagnostic Placement Test.</p> <p>Students will interpret assist.org to discover what courses transferable from community college to CPP.</p> <p>Students will be able to locate petitions on the registrar's website.</p> <p>Students will recognize the importance of time management and visiting professor's office hours</p> <p>Students will be able to identify which courses to take in the consecutive quarter.</p> <p>Students will locate the AP and IB articulation sheets to identify which classes they receive credit for completing the AP/IB tests with 3s or better.</p> <p>Students will recognize important dates such as registration dates and withdrawal dates.</p>
<p><b>Effective Communication (P,T)</b></p> <p>Students will articulate their responsibilities as a learner and student in the College of Engineering.</p> <p>Students will be able to explain FERPA to peers, parents, or other administrators.</p> <p>Students will recognize when they need to meet with an academic advisor if they are</p>



---

seeking help with curriculum choice, personal referrals, or general campus information.

**Meaningful Interpersonal Relationships (P)**

Students will meet at least one student in the advising session in the College of Engineering and discover something about that person.

Students will describe their experience in college to other college students.

Students will articulate to another student what went well in first quarter and what they could improve upon.

---

A survey was conducted to measure the learning outcomes and to gather feedback about the advising program. Approximately 359 students out of 397 students indicated that they plan to see an advisor in the near future for a separate advising meeting. Feedback for the advising sessions has been positive. Students who attended the group advising sessions indicated that they enjoyed meeting other engineering students in the advising sessions. Students who attended the group advising session or the one on one advising meetings indicated that the sessions were both helpful and informative. The advising program also has an intake method to monitor the amount of students that are served on a daily basis. All seven majors are reviewed to determine which majors utilize the advising services consistently. The data has also been used to identify peak times in which students utilize advising services the most. As a result, the advising program has created a daily walk in schedule and has incorporated appointment times to suit the needs of the student population. Both the online tutorial option and the group advising sessions were developed to fit the multiple and diverse learning styles of first year students within the College of Engineering. Approximately 550 students utilized the group advising session option while approximately 200 students opted for the online tutorial which included a one on one meeting with an advisor.

### **Women in Engineering**

Current trends in higher education indicate a low number of women pursuing degrees in the STEM (science, technology, engineering, and mathematics) fields compared to the number of men pursuing such degrees<sup>10</sup>. In both science and engineering, women comprise less than one third of degrees attained<sup>11</sup>. Research indicates that both negative academic and societal views of women in the STEM fields contribute to their unwillingness to pursue a STEM career<sup>12</sup>. As a result of these findings, it is important to recognize the marginalization of women that occurs in the STEM fields. Creating support programs that include areas such as mentorship, community, and academic and social support is a way to improve the challenging environment women experience. The Cal Poly Pomona Women in Engineering Program (CPP WE) began in the Fall of 2012 in response to the low number of women in the College of Engineering. CPP WE was developed to increase the number of women in the college, retention rates among females in the college, and to increase the participation of women in the field of engineering. The program focuses on fostering female student success through outreach and retention activities. Through strategic efforts, CPP WE places emphasis on first year females to integrate them into a learning-centered community of women. CPP WE provides opportunities for female faculty interaction as well as connections to other female students in the college.

CPP WE has initiated various programmatic efforts to improve the retention of women in the college. The CPP WE Ambassadors program was developed to provide support for both outreach and retention initiatives and to provide current female students with leadership opportunities. Ambassador Coordinators undergo an application and selection process and are the leaders of the group of Ambassadors. Students apply for the Ambassador position as a volunteer and are invited to attend quarterly meetings to plan events and activities for the academic year. Currently there are 38 Ambassadors. A majority of the Ambassadors are first year freshmen and as representatives of the

College of Engineering are involved in various outreach events as presenters, tour guides, and resources. They are also utilized for high school outreach visits and any other large scale events focused on outreach to females in the community. The CPP WE Ambassadors also assist with any community building events that are hosted throughout the academic year and are asked to be representatives of the program at events hosted for the current students in the College of Engineering. The college focuses on integrating female first year freshmen at the beginning of the academic year. Female first year freshmen are invited to attend a lunch during the first week of school to welcome them to the College of Engineering community. A select number of current female students in leadership positions are invited to serve as guides, resources, and mentors to the new females. Female faculty and staff are also invited to welcome the new students. The Welcome Lunch is an effort to provide a friendly environment for the students and to introduce them to the opportunities available through CPP WE. Besides the welcome event for females, the College of Engineering has partnered with Housing and Residential Life to incorporate a residential wing dedicated to females pursuing degrees in Engineering. The residential wing is marketed to incoming females and they are encouraged to elect to be a part of the residential community. Activities include facilitating peer to peer relationships through community building activities through collaboration with the College of Engineering. Female faculty are also involved in the residential floor by hosting talks and attending social activities to augment relationships with the female students.

A significant part of the retention component is facilitating and fostering interaction between female students and female faculty. Burke<sup>11</sup> indicates that female faculty mentorship is crucial for women's success in pursuing STEM degrees. As a result of WEPAN's ENGAGE research<sup>13</sup>, CPP WE developed a program for female faculty and students to connect and learn about each other. CPP WE Chats with Faculty were developed and the following learning outcomes for the program were established:

1. Students will learn something new about a female faculty that they did not know before.
2. Students will feel more confident in their abilities as an engineering student.
3. Students will feel comfortable approaching female faculty.
4. Students will be able to seek out a female faculty as a mentor.
5. Students will want to participate in future CPP WE activities.

The program provides women in the College of Engineering an opportunity to have lunch with female faculty from their respective departments. Faculty engage in conversation about their career path to engineering, challenges they have faced in the engineering field, and advice to women pursuing an engineering degree. The Chats are attended by all year levels, including first year students. Assessment indicates increased levels of confidence in engineering abilities among the women, the desire to seek out the faculty hosting the chat as a mentor, increased knowledge about the faculty's life and career, and the desire to attend more events like the one hosted through CPP WE. CPP WE also implemented an alumnae speaker series, CPP WE Talks, to increase positive connections with alumnae and industry partners. One of the factors found to cause attrition in scientific disciplines among women are stereotypes of women pursuing scientific careers<sup>14</sup>. Through the CPP WE Talks, students are able to view alumnae as positive role models for their own career pursuits. The following learning outcomes were developed for the program.

- Students will identify at least one way to overcome a challenge in the workplace related to being a female engineer.
- Students will describe at least one way they can be academically successful in the College of Engineering.
- Students will describe at least one way they can be personally successful in the College of Engineering.
- Students will be able to articulate and describe the job of the featured engineer.

- Students will conclude that an engineering career is both possible and achievable with hard work/persistence.
- Students will discover ways in which they can improve their resume to make themselves more marketable to potential employers.
- Students will identify what steps they need to take to get the job/career they want.
- Students will connect the speaker's experience to their own.

Assessment results have revealed that after the WE Talk, students felt an engineering career to be possible and learned about ways to market themselves to employees. Students indicated that being confident, assertive, and working hard in the workplace are ways of overcoming challenges in the workplace. Students also learned the importance of building a strong network for career opportunities. CPP WE focuses on increasing outreach to women and improving the retention of female students in the College of Engineering. Assessment of the various CPP WE programmatic efforts in 2012-13 yielded positive results. Female students are learning about the engineering field and are excited to pursue an engineering degree and career. Female students are also developing a sense of community and connections not only with each other but with faculty as well. Table 2, shown below, shows the first year female retention rate to the second year from the last two years. Table 2 shows the increases in female retention consistent with the retention rates within the College of Engineering. The female retention rate has considerably risen to almost 90% particularly after the Women in Engineering program began in the Fall of 2012.

Table 2. Retention rates of female engineering students after the first year

<b>Academic Year</b>	<b>Continuation Rate into the Second Year</b>
2007-2008	69.17%
2008-2009	72.28%
2009-2010	77.55%
2010-2011	88.51%
2011-2012	86.92%
2012-2013	89.92%

### **Conclusion**

Overall, the first year programs initiated by the College of Engineering have been successful in engaging and retaining first year students. As highlighted in this paper, first year programs are important to encourage and facilitate student success in college. The programs within the College of Engineering were created to focus on enhancing student learning and development as well as assisting students with integration into the engineering community. Retention is an important component of all three programs. The First Year Experience course began in Fall 2007 while the Advising Program was initiated in Fall 2012 along with the Women in Engineering program. The data below in Table 3 indicates how retention rates have increased over the years with a slight discrepancy from Fall 2010 to Fall 2011 but increasing again to 88% when both the Advising Program and the Women in Engineering program began.

Table 3. Retention rates of engineering students after the first year.

<b>Academic Year</b>	<b>Continuation Rate into the Second Year</b>
2007-2008	73.44%
2008-2009	78.53%
2009-2010	81.43%

2010-2011	88.09%
2011-2012	87.12%
2012-2013	88.38%

The First Year Experience course was designed to enhance both teaching and learning within engineering education in the college. The course has demonstrated success by both increasing student retention and academic success in the college. The First Year advising program has also increased student engagement in the college and is better preparing students for continued success within the college. The program's integration of technology and group advising supports students' multiple learning styles and focuses on initiating an important advisor and advisee relationship that contributes to student achievement in the college. The Women in Engineering Program, although designed to support all students in the college, focuses on developing a sense of community for first year female students and retaining them in the college. First year female students are highly involved in this program both as volunteers and participants of the events and activities. All three programs focus on developing students that embody the institution's 'learn by doing' philosophy and fully integrates student into the engineering community so that they are successful not only as students but in their careers as future engineers.

## Bibliography

1. Tinto, V. (1993). A theory of individual departure from institutions of higher education. In V. Tinto, *Leaving college: Rethinking the causes and cures of student attrition* (pp. 84-137).
2. Pascarella, E. T., Terenzini, P. T. (1980). Predicting freshmen persistence and voluntary dropout decisions from a theoretical model. *The Journal of Higher Education*, 51(1), 60-75.
3. Kuh, G.D., Kinzie, J., Schuh, J.H., Whitt, E.J., & Associates (2005). *Student success in college: Creating conditions that matter*. San Francisco: Jossey-Bass.
4. Kuh, G.D., Cruce, T.M, Shoup, R., Kinzie, J., & Gonyea, R.M. (2008). Unmasking the Effects of Student Engagement on First-Year College Grades and Persistence. *Journal of Higher Education*, 79 (5), 540-563.
5. Chickering A.W. and Gamson, A.F. *Seven principles for good practice in undergraduate education*. Racine, WI: The Johnson Foundation, Inc., 1987.
6. Tinto, V. (1990). Principles of effective retention. *Journal of the Freshman Year Experience*, 2, 35-48
7. Upcraft, M. L. & Stephens, P. S. (1999). Teaching and today's changing first-year students. In M. S. Hunter & T. Skipper (Eds.), *Solid foundations: Building success for first-year seminars through instructor training and development* (Monograph No. 29) (pp. 13-23). Columbia, SC: University of South Carolina, National Resource Center for The First-Year Experience and Students in Transition.
8. Jordan, P. (2000). Advising college students in the 21st century. *NACADA Journal*, 20(2), pp. 21-30.
9. Council for the Advancement of Standards in Higher Education. (2006). *CAS professional standards for higher education* (6th ed.). Washington, DC: Author.
10. Hughes, R. M. (2010). Keeping university women in STEM fields. *International Journal of Gender, Science and Technology*, 2 (3), 416-436.
11. Burke, R.J. (2007). Women and minorities in STEM: A primer. In R.J. Burke & M.C. Mattis (Eds.), *Women and minorities in science, technology, engineering and mathematics* (3-27). Northampton, MA: Edward Elgar Publ, Inc.
12. Jones, J. (2010, July). Closing the Gender Gap. *Civil Engineering*, 60-63.
13. Berry, T., Fletcher, S., Metz, S. S., & Matt, D. (2012, October 26). Two time-effective strategies to improve undergraduate retention in engineering [Webinar]. In *WSKC Webinar Presentations*. Retrieved from <http://www.wskc.org/web/wskc-webinar-presentations/home>
14. Burke, B.A. & Sunal, D.W. (2008). Proceedings from National Association for Research in Science Teaching (NARST) annual conference: *Women in undergraduate physics, chemistry, mathematics, and computer science: How can we sustain them through graduation?*. Baltimore, MD.

## The Study of Gyroscopic Motion through Inquiry-Based Learning Activities

Kathryn Bohn, Jeff Georgette, Brian Self, and James Widmann  
California Polytechnic State University, San Luis Obispo

### Abstract

Students typically struggle with sophomore level dynamics – this difficulty is compounded when the material is extended to three dimensions. To help students gain a physical appreciation for gyroscopic motion, an Inquiry-Based Learning Activity (IBLA) was created. Although most dynamics instructors routinely use a spinning bicycle wheel as a demo, few students get to experience the motion first hand. Similarly, toy gyroscopes can be used to help teach students about precession and demonstrate how gyroscopic navigational devices operate. These hands-on laboratories can be much more powerful than demonstrations and lecturing – the students can actually feel the gyroscopic moments generated. The IBLA was assessed through two problems on the final examination. The first asked what happens to the motion of a gyroscope when you push gently on the outer gimble. The second involved the action-reaction moments involved with gyroscopic motion (e.g., if you are riding your bike and lean to the left, which way do you have to push on your handlebars). Scores on these different problems along with subjective survey results were used to assess the effectiveness of the IBLA.

### Introduction

Due to time constraints and the difficulty of the material, very few universities include three dimensional kinetics and kinematics in their undergraduate curriculum. Cal Poly offers a three- unit dynamics course (on the quarter system) with a subsequent intermediate dynamics class. This intermediate course is a four-unit combined lecture and lab curriculum that facilitates the effectiveness of the hands-on mini-labs and includes significant programming with Matlab. A review of 2D kinematics and kinetics is covered during the first four weeks, including an introduction to computer simulation and numerical techniques. The remainder of the quarter is devoted to three-dimensional motion. During the final week of the course, we cover gyroscopic motion. This is a very difficult concept for most students to grasp, and simple instructor demonstrations don't allow the students to actually feel the gyroscopic moments. To help remedy this situation and hopefully create better conceptual understanding, we created a gyroscopic inquiry-based learning activity.

As a form of active learning, Inquiry-Based Learning Activities (IBLAs) encourage students to actively engage in learning the course material, which is unlike the more passive lecture style typically seen in classrooms. Instead of a professor telling the student's why certain results occurred, the students take charge of their own learning and allow reality to act as the 'authority'. Similar to an experimental procedure, our research had students use the IBLA method to first predict the results of the physical model, then conduct the experiment and finally to complete a worksheet that asks probing questions to test the student's conceptual understanding. Through the hands-on exploration of reality by use of IBLAs, the students will develop conceptual understanding of the intended topics and hopefully break any previous misconceptions. Although most of the research featuring IBLAs is focused on physics, researchers Prince and Vigeant have found evidence that promotes the success of IBLAs in engineering fields. Their research demonstrated the improvement of student's conceptual understanding from the traditional lecture style to the participation in appropriate inquiry-based learning activities<sup>4</sup>.

### Gyroscope IBLA

The activity was composed of three stations involving precision gyroscopes, a bicycle wheel with handles, and a lazy-susan platform. The first station had students apply a moment to a precision gyroscope by attaching a weight to the outer gimbal and observe the resulting precession (Figure 1). The second station had students translate the gyro around the flat table to demonstrate that angular momentum is unchanged in the absence of external moments. They then pushed on the side of the gimbal and observed the precession (similar to one of the final exam questions). On the third station, students held a spinning bicycle wheel by its two handles and yawed about a vertical axis (the spin axis is perpendicular to the outstretched arms). Next, the student held the spinning bicycle wheel by just one handle and rotated it to the side (the spin axis is in the same direction as the outstretched arm). The students also had to apply a roll-moment to the bicycle wheel when standing on a free-spinning turntable, as well as suspend a spinning wheel using a rope attached to its handle.

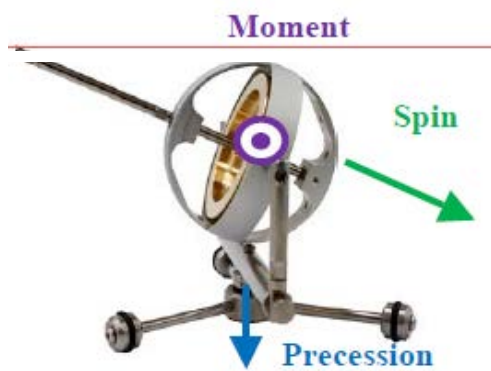

Figure 1. First station figure.



Fig. 2. Students working through station two In Gyroscope IBLA.

Students made predictions (see Appendix A) before running the experiment at each station. Next, they recorded the results on a worksheet (see Appendix B), and responded to the worksheet prompts. Through the inquiry activity, students revisited their predictions and previous ideas after seeing the physical results, and later went on to create informed conclusions. During the hands on activity, the professor and teaching assistants walked around and checked up on student teams to make sure they were doing the activity correctly and helped to answer their questions. The instructors offered additional guidance on how to position the gyroscopes during the activity and how to set up the bicycle wheel on the rope. The concepts that were addressed in this activity were simplified gyroscopic equation (containing moment, precession, and spin) and angular momentum (magnitude and direction). One concept emphasized in the stations was the direction of the applied moment is equal to the cross product of the precession with the spin, where:

$$\vec{M} = I\vec{\Phi} \times \vec{\Psi}, \text{ where } \vec{\Phi} \text{ and } \vec{\Psi}$$

are precession and spin, respectively. For example, if the spin axis is as shown in Figure 1, with the moment coming out at you then the cross product of spin with moment yields the precession pointing downwards.

The concepts in this activity, 3D kinetics and kinematics and angular momentum, are important to understand dynamics. Gyroscopic behavior is very non-intuitive and challenging, thus the physical

activity allows students to see the precession and spin directions and to physically feel the moments applied to spinning rotors. This activity was done for the Intermediate Dynamics class at Cal Poly for the 2012-2013 year. Teams were comprised of three to four students.

### Predictions review

Over the past year we have revised the gyro mini-lab to allow the students more time to discuss the activities in their groups. Originally the activity included four stations, two gyroscopes and two bicycle wheel stations, but in the Spring section the bicycle wheel stations were combined. Students made individual predictions before each station of the activity; the results are compiled in the table below. The prediction questions and worksheet for the Fall section are found in Appendix A and B. There have been some slight changes to the worksheet over the course of our research as the Spring and Winter quarters had the same tasks to complete, but labeled the stations differently (4a-4b turned into 3c-3d). In Fall, we omitted question b of station 3 and question a of station 4 to shorten the activity and allow for more discussion time.



to  
in

been

At station 1 the students were asked to predict how adding a weight on the gyroscope would affect the precession and how changing the weight would change the precession. The students were then asked, in station 2 how translating the gyroscope would affect the spin direction and how an additional force would cause precession. The station 3 prediction questions asked the students to determine the direction the wheel would move when changing its position. This is not intuitive as we are asking them about the resistive forces of the motion. Station 4 asks the students to predict the behavior of the wheel when rotated, again this question deals with the resistive forces from the gyroscopic motion.

Table 1. Prediction correct percentages, winter and spring 2013

Prediction Question	Station 1a	1b	Station 2a	2b	Station 3a	3b	Station 4	4b
Winter 13 (n = 66)	57%	68%	65% <sup>1</sup>	58% <sup>2</sup>	67%	43%	70%	56%
Spring 13 (n = 59)	71%	83%	70%	81%	68%	48%	44%	58%
Fall 13 (n = 85)	73%	-	74%	-	44%	-	-	63%

<sup>1</sup> Erroneous results due to directions not drawn on figure, fixed for spring '13

<sup>2</sup> Mentioned correct concepts on open ended question

Some of the prediction questions appear to make more sense than others to students as the overall prediction scores at each station show no particular trends. The low prediction scores hint that there is room to better understand the concepts by the end of the class term. Student groups rotated through each station at different times – some performed the precision gyroscope station first, while others performed the bicycle wheel station first. The figure below outlines the progression of student understanding as they move through the stations.

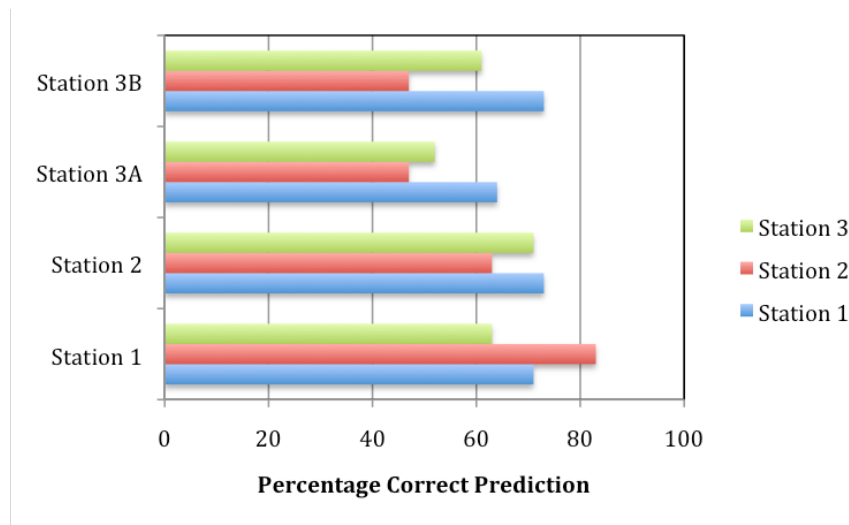

Fig. 4. Percentage of correct responses to prediction sheet questions as the student progressed throughout the stations in the Fall '13 class

For the most part, the student's responses improved as they progressed throughout the mini-labs. The students who started at stations 2 and 3 had a larger improvement than those that started at station 1. We noticed a trend of students who struggled with the prediction question for station 3a, which was independent of what station they started at. Overall, the students appear to have gained conceptual understanding of the topic as they progressed through the labs. In some cases the students demonstrated improvement while others have not fully grasped the concepts. When asked how they made their predictions, some students replied that they used principles taught in the class to make an educated guess while others said that they had played with a gyroscope and knew it would behave that way. For future activities, we want to encourage the students to make predictions using conceptual understanding so that by performing the activity reality will act as the teacher and support the conceptual basis.

### Worksheet Review

Students filled out worksheets in teams for the activity. The research team noted the common conceptions and misconceptions as follows.

#### *Fall Worksheets Response Themes*

On the worksheets, student teams identified fundamental concepts, such as: angular momentum changes when a moment is applied, the simplified gyroscopic equation  $\vec{M} = I\vec{\Phi} \times \vec{\Psi}$  (Moment = Precession x Spin) (Figure 4), the angular impulse momentum equation  $\vec{H}_1 + \int \vec{M} dt = \vec{H}_2$ , and that angular momentum keeps the wheel from falling to horizontal (rope bike-wheel station).

Students wrote different explanations on the worksheet, such as "moment applied causes angular momentum to increase, leads to precession increase." The correct idea is that the angular momentum magnitude stays constant in these experiments, and thus precession is also constant. Also, the moment causes the direction of the angular momentum vector to change, similar to how a force can cause the direction of linear momentum to change.



*Winter Worksheets Response Themes.* Besides answering the worksheet questions correctly, students exhibited the following ways of thinking. Their correct concepts included: moment causes a change in angular momentum thus leads to precession; when precession and spin point co-linearly the cross product is zero thus moment is zero; and angular momentum of objects resists changing orientation unless a moment is applied. They did a good job of writing physical experiment results, what they felt and saw from the experiment. Teams did not utilize the conservation of angular momentum equation much and focused more on the simplified gyroscopic equation. On the other hand, their misconceptions included: precession direction is opposite of the change in angular momentum. Similarly to the previous quarter, one misconception was not putting correct directions for moment-spin-precession axes.

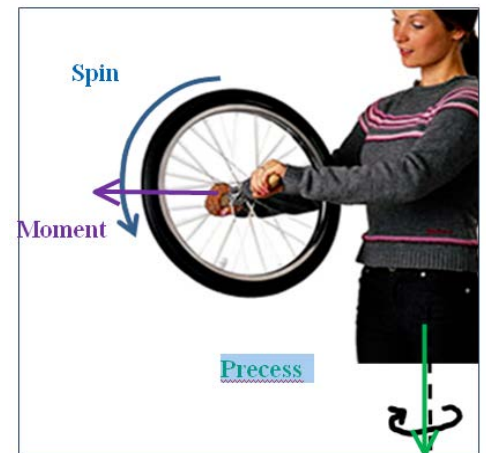

Fig. 5. Precession occurs as person turns to right, they apply counter moment to wheel to keep it in place; station 3a

*Spring Worksheets Response Themes.* Students observed and explained multiple concepts, such as “moment applied to the disk causes a change in the direction of angular momentum, which causes a precession”, and that angular momentum is conserved. On the other hand, misconceptions were listed, such as ‘the spin causes the rod to precess because the new angular velocity changes the angular momentum’. The spring worksheet had spin direction drawn on the figure for station 2, which aided the analysis of the cross products. Students explained their thinking in a way that we could see what they were trying to say, by using figures and vectors.

### Final Exam/Quiz Question

Around the time of the activity, a homework assignment and quiz were given. The homework and quiz were different for each quarter, but shared the idea of reinforcing and testing the relevant concepts. The homework assignment featured an electric fan with a weight on the end to induce precession (winter ‘13) or the precession of a top, and the precession of a simplified space station (spring’13). The quiz featured a) a person holding a bicycle wheel pointing outwards, then turning to the left, and b) find the resultant moment when an automobile’s tires turn during a right hand turn (spring ’13). At the end of the ten-week quarter a final exam problem (see Figure 5) was given to the students to assess their understanding of the gyroscope concepts. The gyroscope at the right (Figure 6) has a spin direction as shown, with angular velocity in the positive  $x$  direction. If you push gently on the outer gimbal in the negative  $x$  direction (shown as force  $F$ ), what will happen (be specific)?

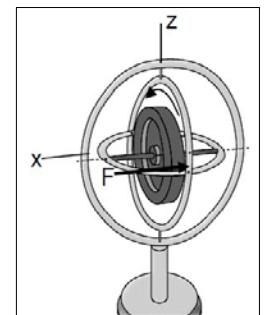

Fig. 6. Final exam question

The grading of the final exam questions follows the format from previous implementations:

- Score of 5 was given if students recognized that the result was a precession of the disk, could apply the correct equation, and compute the axis and the correct direction of the precession.

- Score of 4 was given if students did everything, including finding the correct axis, but gave the wrong direction of precession.
- Score of 3 was given if the students recognized that the result was a precession, wrote the governing equation but then applied it incorrectly.
- Score of 2 was given if the students either recognized precession, or wrote the governing equations but not both.
- Score of 1 was given if student made a basic observation that the force caused a moment, or made some other basic observation.
- Score of 0 was given when the student gave no response or the response showed no understanding of the system.

A second problem, based on a jet engine, (Figure 6) asks students to find the resulting moment acting on the spinning rear-turbine when the aircraft rotates. This problem was modified to the context of a helicopter in motion for the spring quarter '13, and asks the same concept. The assessment scoring is as follows:

- Score of 3 was given if the axis and compensation decisions were both correct
- Score of 2 was given if students found the correct axis, but drew the wrong conclusion on how the pilot should compensate
- Score of 1 was given if students found wrong direction of moment and wrong direction of pilot compensation

The gyroscope activity taught in the 2012-2013 year is different from the activity in 2007 due to a different instructor and an improved worksheet. The same final exam question was asked for different implementations (albeit slightly different contexts for the helicopter problem). Results from the final exam questions are shown in Table 2.

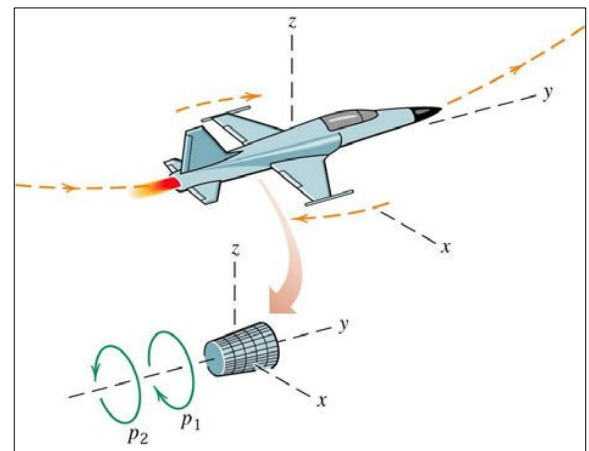

Fig. 7. Final exam question two, rotating turbine in jet. From Meriam and Kraige, 2006

The scores on the final exam problem indicate improvement on the gimbal problem, but a decrease in performance on the jet turbine/helicopter problem. The change in exam scores from spring '07' to fall '07 was found to be not statistically significant (from the ASEE 2008 paper<sup>5</sup>). From looking at the final problem (helicopter problem in spring '13) most students found the correct direction of the rotor moment. But only a few students figured that the moment on the rotor blades is equal and opposite of the moment acting on the craft body. Some students got the symbols mixed up (spin and precession) or did not put terms into the correct units (which changes the magnitude of the answer). On the final gimbal problem, most students figured out the correct resulting precession direction; we attribute this in part due to the hands on activity.

Table 2. Gyroscope exam question score summary

Class	Quiz	Final Gimbal Problem /5	Final Problem Jet turbine/Helicopter /3
Spring '07 (no lab)	-	3.23	2.1

Fall'07 (mini-lab)	-	3.45	2.26
Winter '13 IBLA (n = 29)	-	3.48	2.38
Spring '13 IBLA (n = 69)	6.7/10	4.06	1.9

### Subjective Survey

Students provided feedback on the course, the activity, and their experiences in the subjective survey, summarized in the tables below. A Likert scale was used: 1 = strongly disagree to 5 = strongly agree. The activity was reported as motivating and helpful to students.

Table 3. Gyroscope survey summary.

Class	The gyroscope lab was interesting and motivating	...helped me learn about angular momentum and 3d kinetics	You should do the gyro lab in future sections of the course
Winter '13	4.1/5	4.0/5	4.3/5
Spring '13	4.3/5	4.0/5	4.3/5

The survey also asked when the gyroscope concepts made sense. Each number on the right column states the number of students that realized the concepts made sense for the first time, and understood the concepts afterwards. Through this survey, we found out that 91% (Spring '13, n = 64) claimed to understand the topic after participating in the activity sequence. The breakdown of the survey results indicates the primary times when the students reported understanding were after the first lecture, during the activity and after the process was over. This can be seen in Table 4.

Some selected responses from students on the survey:

- “Gyros are really cool and aren't intuitive.”
- “Gyroscopic motion confused me the most. Partly because it was at the end of the quarter and everything felt rushed. I always confused the moment and the precession.”
- “Gyroscopic motion: It was a difficult concept to grasp because I hadn't seen anything like it before. Working through the activity definitely helped and it all seemed to click once I saw the bike wheel demonstration.”

Table 4. When did the concepts make sense? (Spring 2013)

<i>First time understanding concepts</i>	<i>Percentage of Students</i>
Beforehand	0%
After first lecture	18
During activity	14
Talking with teammates	5
After activity	15
Discussion in class	5
Studying it later	2
After homework	9
During/after post quiz	23
Still confused	9
<i>Total Class size</i>	(n = 65)

When separately asked on the survey “what topic in the course confused you the most?” the response gyroscopes were mentioned 25% of the time (Spring ’13, n = 64).

### Discussion

Overall the hands-on IBLA provided a physical experience with using gyroscopes and bicycle wheels in order to learn the relevant concepts of 3D kinetics and kinematics. Students could feel precession and moments needed to sustain certain spinning motions and witness the non-intuitive nature of precession. Students made sense of the simplified gyroscope equation and were able to apply it to new situations. Students captured the significant concepts of the gyroscope equation and conservation of angular momentum through their worksheet responses. The data from the final exam question suggests slight improvements from using no activity to using the IBLA implementation. The instructor does not do an intervention or explanation for the gyroscope IBLA. Instead, students teach themselves by performing four stations in accordance with the inquiry principles. The subjective survey suggests the activity was helpful and motivating, and should continue in the future as reported by students.

### Improvements

The worksheets will be revised with each implementation in a similar fashion to other IBLA activities developed by our team. Perhaps increasing time to complete the activity will be beneficial towards student learning. Some student suggestions for improvement are:

- *“Make the activity itself more about observing what happens with gyroscopes rather than why it happens. Perhaps the explanations on the worksheet could be completed as homework after the activity rather than everyone rushing to complete them.”*
- *“Due to the order of activities and that everyone started at different stations, the questions grew redundant. If there is a way to make it so that the most basic questions/concepts are always answered wherever you start, and then become more involved from there, it would be better for a growth of knowledge.”*

In addition to altering the prediction sheets and worksheets to give the students plenty of time to conduct the experiment and discuss the results, we will be improving our coding method to analyze the responses. We have begun tracking the students’ responses and after a few more iterations of the mini-labs we hope to see a trend in improving student conceptual understanding. Moving forward, we have begun to revise the gyroscope IBLA to further improve the number of students who truly understand the concept, as illustrated by the results of the final exam. To further promote student discussion, we have condensed the activity to two stations for this upcoming quarter. Students will have a longer time to ‘play’ with the gyroscopes and bike wheels. In addition, an intervention will be added to both activities to further guide the students in their conceptual understanding.

### Conclusions

Overall, the gyroscope IBLA appears to improve student learning and motivation. Most students appreciated the gyroscope IBLA. Although overall performance on exam problems did not improve greatly between Spring and Fall quarters, there was a substantial increase in those who fully understood the question based on a precision gyroscope. The students also made several suggestions to improve the lab, including having a graduate student present to help explain the labs, linking the lab to additional homework problems, and providing a summary to clarify what was done in the lab. By implementing some of these suggestions, we hope to see even greater improvements in future quarters.

## Bibliography

1. Tongue, B. H. and Sheppard, S. D. (2005) Dynamics: Analysis and Design of Systems in Motion, John Wiley & Sons.
2. Meriam, J. L. and Kraige, L.G. (2006) Engineering Mechanics, Volume 2, Dynamics, 6th Edition, John Wiley & Sons.
3. Self, B. P. and Redfield, R. (2001) New Approaches in Teaching Undergraduate Dynamics. Proceedings, American Society for Engineering Education Annual Conference and Exposition.
4. Prince, M. and Vigeant, M. (2006) Using Inquiry-Based Activities to Promote Understanding of Critical Engineering Concepts. Proceedings, American Society for Engineering Education Annual Conference and Exposition.
5. Self, B. P., Birdsong, C. and Rossman, E. (2008) A new spin on teaching 3D kinematics and gyroscopic motion. American Society for Engineering Education Annual Conference and Exposition.

## Appendix A: Gyroscopic Prediction Sheet

### Anonymous Prediction Sheet S 13

**STARTING STATION:** STATION 1 → STATION 2 → STATION 3 → BACK TO 1

Before conducting the experiments, please individually record your predictions on this sheet of paper. Your answers will not be graded so do not worry if your predictions are wrong!

#### Station 1

a) When you release the rod, which direction will the gyro precess?

\_\_\_\_\_ *CW*      \_\_\_\_\_ *CCW*      (*view from above*)



b) How does the added weight change the speed of precession?

83.05% *Speed up*      \_\_\_\_\_ *Slow Down*      \_\_\_\_\_ *No speed change*

#### Station 2

a) When tripod base is translated around the table, what direction will the spin axis of the gyro move?

\_\_\_\_\_ *Precess +z axis*      \_\_\_\_\_ *Precess +y axis*  
 \_\_\_\_\_ *Precess +x axis*      \_\_\_\_\_ *No directional change*

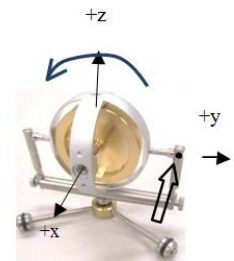

b) If you push on the right side of the gimbal as shown, what will happen to the rotor?

#### Station 3

a) As the wheel spins away from you and you turn your body to the right, what direction will the wheel tilt? (as shown in the figure)

\_\_\_\_\_ *Tilt to your right*      \_\_\_\_\_ *Tilt to your Left*      \_\_\_\_\_ *No tilt*



b) What direction does the wheel make your arm move?  
 (see figure for spin directions)

Up       Down      (from looking out perspective)  
 Left       Right       No change

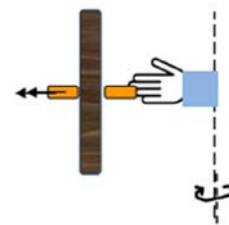

**Station 4**

a) Make a prediction about which direction you will yaw on the platform.

Rotate Left       Rotate Right       Rotate Left



b) Predict the behavior of the wheel when it is supported by a string attached to the outside of the handle (explain your answer)

**Appendix B: Gyroscope Worksheet**

Gyroscope Mini-Lab (you will turn this in at the end) SPRING 2013

Recall : --  $I \vec{M} = \dot{\vec{\phi}} \times I \dot{\vec{\psi}}$  and  $\psi$  are about spin axis,  $\phi$  denotes precession

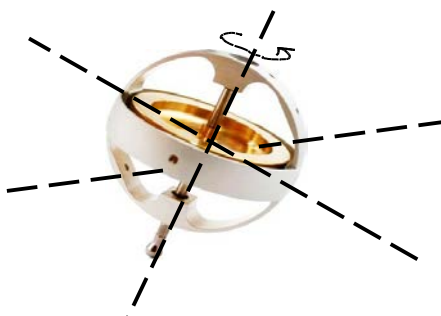

**Precision Gyroscope (Please do not drop these; they are very expensive)**

Please record your predictions on a separate, anonymous sheet.



**Station 1**

*Make your prediction under Station 1(a) on the Prediction Sheet*

To spin-up the gyro, connect the electric motor to the top part on the gyro, and turn on the switch on the motor box. Looking at it from the top (where you attach the motor), the rotor will rotate counterclockwise. Make sure to remove the motor from the gyro after spin-up. A short rod is attached to the outer ring; hold the rod in the air at an angle above horizontal and release.

*What causes the rod to precess?*

*Watch the gyro precess. Push up or down gently on rod. How does the motion change as the rod is moved up and down? Are you surprised by the force necessary to move the rod up or down?*

*After the experiment, Sketch a figure with vectors to help explain. Describe in words what is happening with regards to the angular momentum.*

*Read the next description and Make your prediction under Station 1(b) on the Prediction Sheet. Next, attach the weight to the end of the rod. How does the added weight change the speed of precession?*

## **Station 2**

*Read the description below for the next activity, before doing the activity, and make your prediction under Station 2(a) on the Prediction Sheet.*

Let the rotor point at some oblique angle (not vertical or horizontal). While holding the base, slowly slide the system around on the table. (Prediction 2a). After that, slowly lift a base leg off the table surface, no more than 1 inch high. Do this for each leg. (No prediction for lifting a base leg off the table). The orientation of the rotor should point the same direction even if the base moves since there is no moment applied to the rotor (due to the gimbals).

*Why does the spin axis remain at the same orientation? If the rotor has constant spin speed, how might a spinning rotor be used to help orient a satellite?*



*Make a prediction under Station 2(b) on the prediction sheet about the gyro tilt direction from pushing on the right side of the gimbal.*

With the rotor spinning in the vertical plane as shown, gently push on one side of the gimbal.

*Explain what happens using a figure and the gyroscopic equation.*



## **Station 3**

### **Gyroscopic Bicycle Wheel**

*Read the description below for the next activity, and before doing the activity, make your prediction under Station 3(a) on the Prediction Sheet.*

Have one person on the team hold the wheel as shown, and a second person push down on the wheel to get it spinning (spin direction on figure). Rotate your body to the right, (clockwise from above), over  $360^{\circ}$ .

*After doing the activity, what do you feel from the handles as you turn your body right? What do you have to do to the wheel to make this motion happen?*

*Read the description below, and before actually doing the activity, make a prediction under Station 3(b) on the Prediction Sheet.*

Hold one of the wheel handles with one hand, so the other handle pointing straight away from you. As you look out from your body/arm, spin the wheel CW. Then rotate your arm and body to the right.

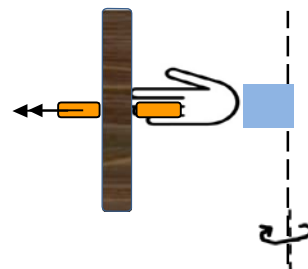

*After running the activity, show how and why this happens using a sketch and appropriate equations.*

### Station 3 Continued

*Read the description below, and before actually doing the activity, make a prediction under Station 3(c) on the Prediction Sheet.*

You will need to share one of the rotating platforms with the other bicycle wheel groups, so some of you should start with part d.

c) You will need to get the wheel spinning fairly fast and do the demo right after it starts spinning. Hold the wheel in front of you like shown in the picture. Tilt the bike wheel to the left about 30 degrees (if you did this through a full 90 degrees it would be horizontal).



*After doing the exercise, What happens? Move it back. Describe what and why this happens.*

d) *Read the description below, and before actually doing the activity, make a prediction under Station 3(d) on the Prediction Sheet.*

Lastly, spin the wheel in a vertical plane as fast as you can with the string attached onto a side handle (like the figure at right). Then hold onto the string and watch what happens to the wheel gyroscope.

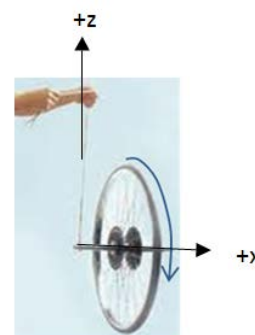

*After running the activity, What happens and why? Explain your answer using a sketch of the vectors and the simplified gyroscopic equation*



## **Cyber Education Motivated the Creation of the Virtual Instruction Cloud CLaaS, a New Distance Learning Modality**

Baird Brueseke and Gordon Romney  
iNetwork, Inc./ National University

### **Abstract**

Cyber security training and skills can best be learned by hands-on, experiential learning. Virtualization facilitated the delivery of the computing resources needed to complete hands-on lab exercises. The accelerated need for cyber warriors in the workforce led to the design of an online MS in Cyber Security (MSCS) program in an internet-paced delivery modality of one-course-per-month format. Usage of a virtual computer lab for hands-on learning in both the online and onsite curriculum became the signature differentiator for this MSCS program. Out of necessity, the delivery infrastructure evolved from a LAN to a private cloud as virtualization facilitated cloud deployment. The progression has been “hands-on”, “virtualization”, “need for accelerated teaching”, “online”, “one-course-per-month” to “cloud”.

The constant challenges of managing a sophisticated private cloud for National University led the authors to identify the requirements embodied in the class/lab module of the Virtual Instruction Cloud (VIC), a new model for distance education. CLaaS, or Computer Lab-as-a-Service is a trademark of iNetwork and embodies features of the class/lab module. Additionally, recent advances in technology including new mobile devices, the ability of MOOCs to reach thousands of students (distance learners) and the wide spread use of social media as a ubiquitous communication method have reshaped the educational environment, reinforcing the need for CLaaS.

A Computer Lab as a Service (CLaaS) in the cloud enhances the educational content delivered by MOOCs; and specifically, cyber MOOCs. Together, VIC and its computer class/lab module, herein referred to as CLaaS, deliver new technology, provide provenance for new forms of educational content, protect developer IP and also protect academic revenue streams. This paper describes CLaaS. CLaaS allows the instructor to return her focus to teaching. Today, CLaaS is particularly useful in meeting the special needs of the cyber education community in its drive to better prepare cyber warriors to secure the future of our global infrastructure and economy.

### **Introduction**

There are ongoing debates regarding the relative value of theoretical versus practical knowledge. Computer Science and computer-intensive disciplines require students to utilize both theoretical and practical methods of learning. Successful entrepreneurs do not succeed in the modern world if they cannot combine theory with practical application of algorithms that perform useful functions. Ever since the advent of computer technology education in the 1960s, academic institutions have invested large sums of capital to equip their programs with the computing equipment necessary to support the learning outcomes defined in their computer related curricula<sup>1</sup>. Innovative programs provide students with an educational experience that conforms to this axiom. Distance learning methods have now evolved to the point that academic institutions have the ability to offer students vetted course credit via instruction methods that

invoke both methods of computer science learning (theory and practical application of knowledge).

Siemens pioneered open Connectivist courses for over 15,000 students and educators in thirty countries and his colleagues, in 2008, named these the first Massively Open Online Courses (MOOC)<sup>2</sup>. Siemens, Groom and Couros base their online teaching on a pedagogical participatory model (Siemens, 2012; Groom, 2012; Couros, 2012) that differs from the elite and well-funded university model (Coursera/EDx) that was initiated in 2012-13 and is more publicized. Siemens distinguishes between the two as being Connectivist (Siemens, Couros) versus Constructivist (Coursera, EDx). The Connectivist model is an online teaching method based on a participatory pedagogical model. Constructivism is a learning model which is now vying for a place in the mainstream educational process as a new educative practice. As Egan stated in 2004: “.. the Constructivists adopt a traditional view of knowledge and learning. Instead of distributed knowledge networks, the Constructivist courses (now, generally referred to as MOOCs) are based on a hub and spoke model with the faculty (knowledge) at the center and the learners replicators of knowledge) as spokes.<sup>3</sup>” However, these diverse Connectivist and Constructivist perspectives can be combined in a hybrid model, CLaaS, which is the premise of this paper. The Computer Lab as a Service platform developed by the authors is a tool that Computer Science instructors, being the focus of this paper, will find useful in their delivery of both educational theory and hands-on instruction.

### **CLaaS Definition**

Computer Lab as a Service (CLaaS) is a cloud based system that provides educators with a platform to create and deliver computer based laboratory (lab) exercises to students. CLaaS is ideally suited to provide unique capabilities for distance education, and it also functions in a traditional brick and mortar environment. CLaaS combines virtual machines and network resources in a lab configuration that emulates real world computing technology supported by a pedagogical learning infrastructure that makes the lab useable by instructors with minimal personal administration, configuration and maintenance.

The lab environments created in CLaaS are tied directly to specific learning outcomes and more granular learning objectives defined in the academic progress tracking system. CLaaS is one instance of the Class/Lab module identified in the Virtual Instruction Cloud (VIC) patent developed by the authors. The CLaaS product features are a product of industry observation (iNetwork, Inc.) and analysis which occurred during the agile development of an MS in Cyber Security and Information Assurance (MS-CSIA) program created and deployed at National University (NU).

The Virtual Instruction Cloud (VIC), of which CLaaS is just one component, represents a new pedagogical model for higher education which synergistically incorporates current social behavior in an academic system. VIC combines both Connectivist and Constructivist theories in a way that provides structured accreditation for MOOCs and preserves the revenue stream for traditional academic institutions. Increasingly, virtualization (and changing trends in on-line education such as MOOCs) provides a greatly enhanced service capability at a significantly reduced cost per student. The Constructivists disagree, pointing out that their MOOCs are based on a hub and spoke model which maintains the faculty and the knowledge at the center and the

students external to that nexus. VIC falls somewhere along the continuum, depending upon administrator preference, between the Connectivist and Constructivist models and, consequently, the traditional fee structure and higher education revenue model will still apply.

The premise of this paper is that CLaaS provides university administrators, department chairs and faculty with a tool that reduces capital expenditures by changing the financial model for hands-on-computer technology labs from a capital outlay to an operating expense. At the same time, CLaaS represents a transformative educational technology which shifts the computer education landscape and refocuses it on emerging Web 2.0 and 3.0 trends in student directed learning represented by MOOCs, YouTube videos, Coursera and other new on-line learning methodologies.

### **Computer Lab Libraries**

Based on the observations of current industry trends, as well as additional work done by the authors researching CompTia, SANs Institute and ECC certificate programs, the following labs have been defined and pre-configured in the CLaaS Lab library.

#### Individual Labs (one student, one virtual machine)

Kali Linux	Ruby on Rails
Backtrack 5	MySQL Database Server
Metasploit	Apache Web Server
Security Onion	OWASP
Win2k10, IIS	Burp Suite
Win2k10, Domain Controller	Vyatta Router
Wireless Access Points (virtual)	PSI firewall

#### Teaming Labs (multiple students, multiple virtual machines)

Red vs. Blue Team  
 Penetration Testing  
 Small Business, Single Domain, Multiple Departments  
 Enterprise Business, Multiple domains, virtual WAN

In addition to these pre-defined labs, the authors have dialoged with professors at the University of Southern California (USC) Viterbi School of Engineering, Information Sciences Institute (ISI) about the possibility of integrating some of the DeterLab<sup>4</sup> functions currently used in the USC Cyber Security Master's program with a remotely accessible CLaaS portal. The pre-defined lab environments listed above are specific to the Cyber Education space. Although the Cyber Education space represents the initial target market for CLaaS, the implementation of specific laboratory environments for a large variety of computer science educational topics is consistent with the ease of use concepts embodied by the CLaaS eGUI and database structures.

There have been a number of papers published on the implementation of educational computer science laboratory environments using virtualization (VLabs). During the requirements definition phase of the CLaaS product development process the authors referenced their own experience dating back to 2001, as well as that of their academic peers which was discovered during abstract and journal research on VLabs and distance education. As result they would like to acknowledge and thank their peers in both the Department of Defense<sup>5</sup> as well as the

commercial space<sup>6,7,8</sup> for their efforts to publish innovative ideas on VLabs. For researchers in any field, it is most helpful to observe experiences by others that corroborate one's own assumptions, theories and models. The CLaaS product features presented in the following sections build on the general capabilities represented by virtualized and cloud-based computing resources to create a unified virtual computer laboratory system which higher level (Department Chairs and Professors) educators can use to create and maintain a variety of computer laboratory environments.

### CLaaS Educator Graphical User Interface (eGUI)

Instructors interface with CLaaS via a user-friendly educator graphical user interface (eGUI) that provides setup and configuration functions for virtual machines as well as virtual appliances such as routers, switches and firewalls. A variety of network infrastructure models are supported including single and multiple virtual local area networks (vLANs), multi-level tree structures and virtual wide area networks (vWANs). Students interface with CLaaS via their own computer and a VPN connection into an "Arena" (think sandbox) environment, preconfigured with the virtual machines, appliances and the network structures necessary for course specific learning outcomes. Outside observers have the opportunity to monitor both instructor and student actions. The following screen shot depicts the CLaaS Main Menu:

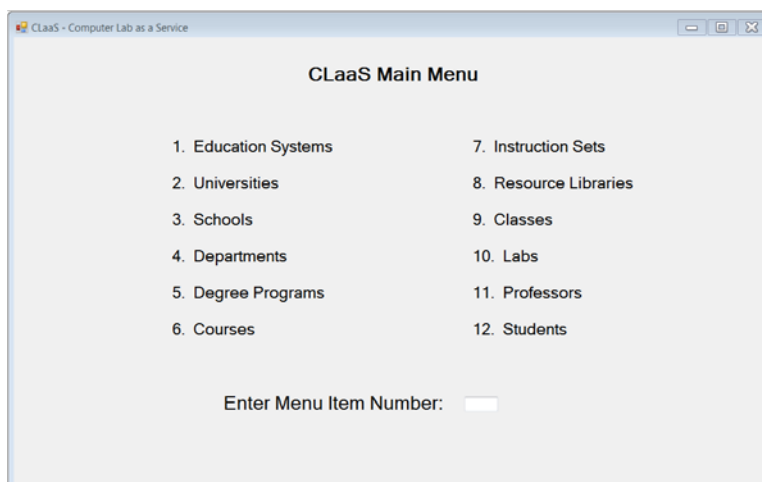

Figure 1. CLaaS main menu.

### Academic Variables

As indicated in the preceding section, many individual professors and the schools they are associated with have experimented with and implemented a variety of virtual lab (vLab) environments. CLaaS is unique because it builds on these experiences to define an approach to vLabs that incorporates both academic-administrative and technological parameters. Academic-administration is addressed as opposed to technological administration (for example system administration of a network infrastructure) that would be covered in the technological area.

Many universities have attempted to setup and administer vLab environments thinking that it is simply a matter of outsourcing technology, when, in reality, there is an academic-administration requirement that must be filled because faculty want to teach and not administer. This is where CLaaS becomes unique and stands out as it provides both a technological as well as an

academic-administration solution. Courseware must be developed and maintained as the labs just do not magically come together for a given class without structure and organization simply by assigning a group of virtual machines to a specific semester class. This section will describe some of the database table structures which CLaaS implements to track student progress against specific course objectives and learning outcomes. The CLaaS Academic Progress Tracking System uses the following database tables structures as part of the laboratory setup and configuration process:

<i>Table Name</i>	<i>Sample (examples) Table Entries</i>
Education System	University of California or California State and their various campus locations Bridgepoint Ashford and other institutions
University	UCSD, UCLA, SDSU, Cal State San Marcos Ashford is a University, but also part of Bridgepoint National University (NU) is a single entity with 28 schools Coleman is a single college
Schools	Viterbi School of Engineering (USC) Forbes School of Business (Ashford) School of Engineering Technology and Media (NU)
Course	A defined set of material with specific learning objectives
Instruction Sets	A set of content objects sequenced in a manner that facilitates learning. Specifically, the knowledge acquisition and retention of the information defined by learning objectives associated with the successful matriculation of the course.
Resource Library	A collection of content objects which includes educational material in many forms including word documents, power point presentations, video clips, pictures, animations, audio tracks and virtual environments.
Class	One instance of a course A defined group of students are enrolled in a course A class has a professor A class may be taught on-site and have a classroom number A class may be taught on-line and thus not have a physical room A class may have one or more laboratory environments (arenas) An arena may have one or more lab assignments The Class table is a container which in conjunction with other database tables will track student academic progress
Lab	A laboratory assignment may have one or more learning objectives Labs, via their association with a class will have specific students

A lab assignment will have a student performance rubric  
 Labs may be persistent (re-entrant) or non-persistent  
 Final lab configurations will be maintained beyond the last day of  
 class to accommodate both grading and protest periods

These database structures are presented to the user (typically lead professor) in a menu driven graphical user interface that facilitates the definition of specific course learning objectives, which then serve as the driving factors for class specific assignments. In addition, the database tables listed below support a variety of other administrative functions such as:

- | <i>Table Name</i>                   | <i>Sample Table Entries</i>  |
|-------------------------------------|--|
| • Tracking                          | Student ID:course:date:cohort:grade                                |
| • Demographic Info                  | Student ID:Name:Specialization:Status (active/drop out)            |
| • Student Enrollment Status History | Contact info, User/Password, Qualifications, Pre-Requisite History |

### Virtual Machine and Network Structures

The CLaaS laboratory arena setup and configuration function provides the user (typically lead professor) with a menu driven system that makes it easy to choose and define specific technical elements. Some of these functions include:

- Virtual Machine (vm) Templates: currently the library contains more than 100 vm ISOs including a variety of Windows and Linux operating systems
- vLan Types: Null, Flat, 2 vLans, 1 level Tree (3 vLans),
- Virtual Switches
- Virtual Routers
- Virtual Firewalls
- Virtual Wide Area Networks (vWan), Simulated ISPs, vWAN with multiple domains

The following screen shot depicts the CLaaS Network Selection GUI:

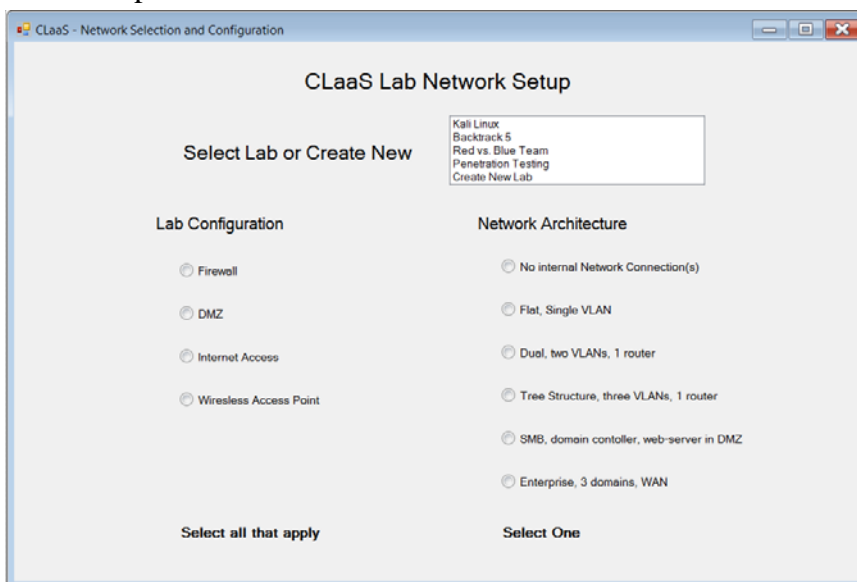

Figure 2. Laboratory network setup.

The following screen shot depicts the virtual machine selection process:

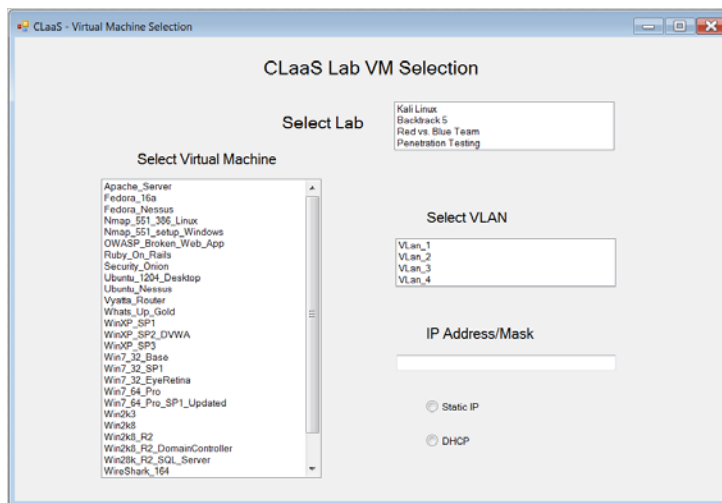

Figure 3. Laboratory virtual machine selection.

One of the unique features of CLaaS is the ability to support teaming environments. CLaaS goes beyond the simplistic one student, one virtual machine concept. CLaaS is capable of using multi-factor authentication combined with Active Directory credentials and two factor authentication<sup>9</sup> to provide role based access to specific sets of computing resources. Figure 4 depicts a multi-student, teaming environment.

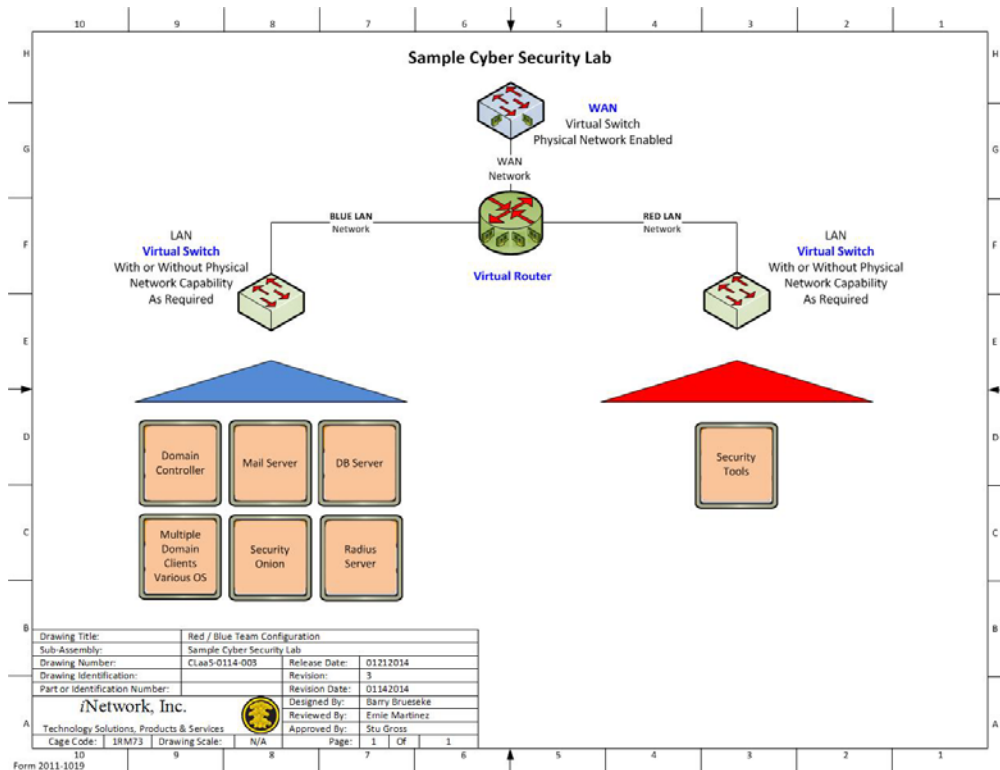

Figure 4. Example, multi-student/multi-team lab configuration.

This multi-student, teaming capability expands the teaching horizon from individual exercises to include team based assignments such as Capture the Flag and Red/Blue team warfare simulations. Access to multiple resources provides curriculum designers with the ability to simulate both small/medium sized businesses (SMB) and larger, enterprise class environments.

“Hands-on lab exercises play an important role in teaching a computer and network security course because they can help students apply basic security principles and techniques to the protection of real world computer and network systems.<sup>6</sup>” The ability to incorporate real world scenarios in a hands-on environment provides the academic institution with the ability to promote the unique and superior nature of its computer science education program. The CLaaS Academic Progress Tracking System records student participation in laboratory exercises and facilitates the class grading process used by the instructor to ensure students have completed the associated rubrics to necessary for academic credit.

### **CLaaS Deployment**

Content specific vLabs, setup using the CLaaS modules shown in Figures 2 and 3 are available (7x24) at a website portal accessible by anyone with a broad band internet connection and valid login credentials. The vLab setup and configuration process can be performed by faculty. An alternative is available in the form of a professional services team, trained to ensure that specific learning objectives are implemented, tested and ready for use prior to the 1<sup>st</sup> day of student activity. The product is currently in beta testing, with full deployment scheduled to support the 2014 fall semester. There are multiple pricing tiers dependent upon the complexity of the desired vLab configuration. For example, vLabs with multiple vLans and multiple virtual machines (VMs) per student will cost more than simple vLabs consisting of a flat network and a 1:1 student/VM ratio. The target price for basic CLaaS vLab configurations is the cost of an expensive text book. The business model assumes that academic institutions will develop (setup/configure) vLabs with specific learning objectives prior to the start of a semester and then reserve vLab space in the CLaaS portal based on expected enrollment for the course(s) to be taught during a semester. It is anticipated that institutions will have the ability to pass the cost of vLabs on the students in the form of a lab fee.

### **Conclusion**

Advances in virtualization technology have provided academic institutions with opportunities to deliver computer science education using innovative techniques. These opportunities have brought with them both change and conflict. Many instructors have embraced the chance to provide their students with hands on experiential learning opportunities using cutting edge technology. Conflicts arise when academic institutions are unable to approve curriculum changes in a timely manner. Additionally, the responsibility for system maintenance and repeatable delivery of consistent laboratory experiences from class to class is a challenge that grows larger as the use of virtualization methods increases.

The system administration role in computer science laboratories has traditionally been performed by graduate students and/or representatives from the academic institutions Information Technology department. The increasing adoption of virtualization technology has made it possible for instructors to define and create lab environments tailored to their teaching methods.



Now that this practice is become widespread, institutions need new methods to define and deploy easily laboratory configurations in a repeatable manner which is consistent with course learning objectives. This need applies to courses taught in both brick and mortar classrooms as well as the virtual classrooms populated by distance learners.

The nation faces an ever growing number of cyber security threats from causal hackers, cyber criminals, adversarial nation states and other bad actors. These threats are evolving at an exponential pace. There is presently a significant shortage of qualified cyber security engineers in the workplace. The academic community has the opportunity to address this shortage with new computer science programs focused on computer network defense and other areas of cyber security study. New tools are required to develop and implement the new curriculum in a time cycle required to keep pace with the rapidly evolving field of cyber security.

The Computer Lab as a Service platform CLaaS developed by the authors meets these needs. CLaaS provides Department Chairs and Lead Professors with a tool which maps computer science labs to learning objectives and learning objectives back to specific courses. In addition, CLaaS provides an Academic Progress Tracking System which records Professor and Student activities and accomplishments. CLaaS is unique in that it combines these important academic functions with an innovative graphical user interface that allows users to easily establish libraries of various computer science laboratory configurations. A CLaaS lab configuration can range from a simple collection of virtual machines in a non-networked environment all the way up to a complex simulation of an enterprise network environment consisting of multiple domains connected across a virtual wide area network. The library function addresses the important issue of repeatability. Once defined, the particular lab associated with a course's learning objectives can be easily redeployed for each new class of students, ensuring hands-on learning experiences consistent with the standards of education excellence demanded by institutions with rigorous accreditation standards. Most important, CLaaS standardizes the use of virtualization technology and allows the instruction to return their focus to teaching.

In the last few years, virtualization has facilitated the delivery of the computing resources needed to complete hands-on lab exercises. The use of virtualization has brought with it increasingly more time consuming setup and administrative tasks which have grown beyond the normal duties performed by faculty and staff. CLaaS allows the instructor to return her focus to teaching. Today, CLaaS is particularly useful in meeting the special needs of the cyber education community. In the future, CLaaS will be used to deliver a broad range of experiential learning activities to the growing population of distance learners.

### **Glossary of Information Technology Terminology**

*Agile:* Ability to move quickly as applied to pedagogy, delivery, development and management.

*Authentication:* Validating identity of a person or object.

*CLaaS:* Computer Lab as a Service. Specific computer services delivered via cloud resources.

*Cloud:* The internet or network of computing resources; may be either public or private.

*Cloud computing:* The delivery of computing resources or services via the internet.

*Cyber security:* The discipline of securing computer resources and information.

*Firewall:* A hardware or software system designed to prevent unauthorized access to an infrastructure.

*Golden image:* A deployed 'iso' image of a virtual machine ready for use and lab exercise.

*Hypervisor:* Computer software or hardware that manages and executes virtual machines.

*Infrastructure:* Physical computing hardware and resources that are part of a network, a cloud or the internet.

*Private cloud:* A cloud that is private to an enterprise and may be physically local to the user.

*Public cloud:* A cloud available to the public at large and normally physically remote from the user.

*Virtual laboratory:* Facilitates the use of virtualization in laboratory exercises.

*Virtual machine:* An instance or emulation of a real, physical computer with its own segmented, private, unshared operating system and memory space.

*Virtualization:* The act of using a hypervisor and virtual machines to provide a virtual, non-physical computing resource environment.

*VM:* A virtual machine.

*Web 2.0:* The second stage of implementation of the World Wide Web or internet characterized by social networking and general collaboration.

*Web 3.0:* The next, future and anticipated evolution of the World Wide Web that has been under definition for at least five years.

*Wi-Fi:* Wireless technology that uses high frequency radio waves to send and receive data and normally connects with the internet.

*Wireless network:* A computing infrastructure that supports cable-less connectivity of computing and mobile devices frequently through Wi-Fi technology.

## Bibliography

1. Romney, G.W. & Brueseke, B. W. (2014). *Merging the Tower and the Cloud through Virtual Instruction: The New Academy of Distance Education*, The Journal of Research in Innovative Teaching (JRIT), La Jolla, CA, Vol. 7, Issue 1, March 2014, p. 93
2. Siemens, G. (2012). *What is the theory that underpins our moocs?*, ELEARNSPACE, retrieved December 4, 2013 from <http://www.elearnspace.org/blog/2012/06/03/what-is-the-theory-that-underpins-our-moocs/>
3. Egan, K., (2004). *Getting it Wrong from the Beginning -- Our Progressivist Inheritance from Herbert Spencer, John Dewey, and Jean Piaget*, New Haven, CT: Yale University Press.
4. Deter Project (2013). <http://deter-project.org/deterlab-cyber-security-science-facility-capabilities>
5. Brown, C, Crabbe, R.D, Greenlaw, R., Hoffmeister, C., Monroe, J., Needham, D., Phillips, A., Pollman, A., Schall, S., Schultz, J., Simon, S., Stahl D., Standard, S. (2012). *Anatomy, Dissection, and Mechanics of an Introductory Cyber-Security Class's Curriculum at the United States Naval Academy*, Computers in Education Journal, United States Naval Academy, Annapolis, Maryland 21402.
6. Yue, C., Zhu, W., Williams, G.L., Chow, E. (2012). *Using Amazon EC2 in Computer and Network Security Lab Exercises: Design, Results, and Analysis*, in proceedings of the ASEE National Conference, San Antonio, 2012
7. Li, P., Jones, J.M., Augustus, K.K. (2011). *Incorporating Virtual Lab Automation Systems in IT Education*, in proceedings of the ASEE conference, 2011.
8. Anderson, R.C. & Romney, G.W. (2013). *Comparison of Two Virtual Education Labs – Closing the Gap Between Online and Brick-and-Mortar Schools*, IEEE ITHET, 2013Conference, Antalya, Turkey, In Press
9. Romney, G.W. & Juneau, P.D. (2009). *Implementation of Efficient Two-Factor Authentication for University Computer Systems*, ASEE-PSW 2009 Conference, San Diego, CA March 19-20, 2009

## **Learning by Doing, a Method to Engage Underrepresented Minority Students Learning Electrical Circuits**

Marissa Buell, Nehad Dababo, Rene Figueroa, Peter Moala,  
Amelito Enriquez, Kanjun Bai, Hamid Mahmoodi, Cheng Chen,  
Kwok-Siong Teh, Hamid Shahnasser, Wenshen Pong, and Hao Jiang  
Cañada College/ San Francisco State University

### **Abstract**

Basic electrical circuit analysis is always perceived to be a hard-to-comprehend course for most undergraduate electrical engineering students, especially those from underrepresented minority groups. To help those students gain a strong fundamental understanding of basic electrical circuit theory, a learning-by-doing approach was designed for students who have recently taken a basic electrical circuit course. Funded by a NASA CIPAIR (Curriculum Improvements and Partnership Award for the Integration of Research) grant, four underrepresented minority (*i.e.*, 3 Hispanic and 1 Pacific Islander) students from a community college were recruited to design, assemble, and test a printed-circuit-board (PCB) based circuit in the summer of 2013. The circuit is capable of taking in power at 1.6 KHz with a very low voltage level ( $\sim 200\text{mV}$ ) and converts it to 5 V DC power to power-up biomedical implants wirelessly. First, the students were asked to run the circuit simulator (*i.e.*, LT-spice) to optimize the existing previously designed circuit. Then, they designed their own board and assembled the components. In the end, they thoroughly characterized the circuit that they put together. In the ten-week period, the students went over the complete board-level circuit development flow: from the design to the test. Their understandings of electrical circuit theory was dramatically improved as manifested in their project report and final presentation. The feedback from the students demonstrates that the NASA CIPAIR is an effective method to engage underrepresented minority students to learn electrical circuit theory with the learning-by-doing method.

### **Introduction**

Electrical Circuit Analysis is a fundamental course that is of great importance for many electrical engineering (EE) disciplines. Nationwide, it is a required course in the EE undergraduate curriculum. In spite of its importance, most students perceive the circuit course as one of the most abstract courses in the undergraduate curriculum<sup>1</sup>. This perception is largely attributable to the following reasons: 1) the classical approach of teaching circuit principles is based on linear algebra and complex number. The traditional chalk/blackboard instruction is in many cases difficult to follow for students with weak mathematics skills and they often feel lost; 2) students perceive the course is “too theoretical”, therefore, irrelevant for their education<sup>2</sup>. Students lose interest in the course as soon as they fail to see how the principles that they learn in the course relate to practical applications<sup>2</sup>. The prevailing perception for students is that circuit analysis is difficult, esoteric, boring, and irrelevant, disengages them in learning it. Minority students in the community college feel the course is even more of a challenge, which results in low success and retention rate in the field the electrical engineering. How to actively engage students, especially underrepresented minority students in this area is a challenge to engineering educators nationwide.

“Replacing standard laboratory courses with discovery research” is one of the five effective

methods to engage and excel underrepresented minority students in the STEM field in the 2012 PCAST report<sup>3</sup>. To facilitate community college students' learning the basics of electrical circuit, especially those from underrepresented minority groups, Cañada College, a Hispanic serving community college, joined forces with San Francisco State University, a four-year university, to create an internship program that provides opportunities for underrepresented minority students to carry out circuit related projects. Supported by NASA 2013 CIPAIR program, four students joined the Electrical Engineering research program at SFSU.

### Project Background

The project was to miniaturize the receiving coil size in the two-coil wireless power transfer scheme, by significantly reducing the turn-on voltage of the AC-DC boost converter that is used to rectify the harvested AC power. The circuit is to be used for biomedical implants so that the miniaturized receiving coil can be fit into miniaturized implants. The research group in SFSU has proposed a new approach, which uses a controlled switch, to efficiently convert the received low-voltage AC power to a high-voltage DC power<sup>4, 5</sup>. The participating students were asked to improve a prototyping board, as shown in Fig. 1 (a), to eliminate all the extra wires, so that the final circuit is like Fig. 1(b).



Figure 1. The printed circuit board for this project. (a) the prototype, (b) the improved version.

### Project Description

Four students (i.e., 4 Hispanic including 1 female) students from Cañada College participated in a ten-week research project to design a power harvesting apparatus for implantable medical devices. The project is divided into three phases.

*Phase 1: Understand the Circuit Operating Principle.* First, all four students are asked to read prior publications<sup>4, 5</sup> as illustrated in Fig. 2. The operating principle of the proposed circuit is the following: With the main switch on, the current takes the path of least resistance and charges the power coil (receiver coil), as in Fig. 2 (a). When the main switch is shut off, as in Fig. 2 (b), the current flows through the rest of the circuit, where each of the components creates a voltage drop. The current that returns to the coil is much less than the current provided by the power coil. The voltage across an inductor is proportional to the change in current over time. The large decrease in current over a short period of time yields a large jump in voltage. With the main switch off, the coil acts as a voltage source and charges the load. Through this principle, a large DC output voltage of  $\sim 5V$  is attained from a small AC input voltage of  $\sim 200\text{ mV}$ .

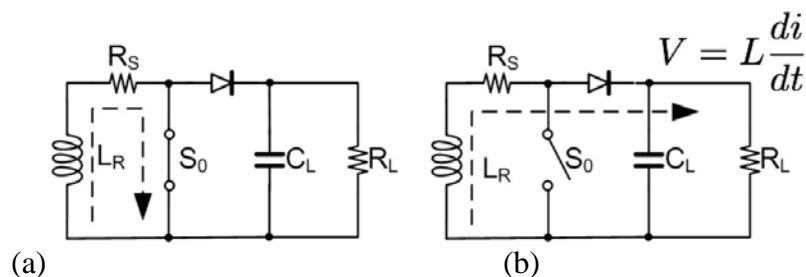

Fig. 2. (a) With the main switch closed, the current rises through the power coil. (b) With the main switch open, the magnetic energy stored in the power coil is released and the coil acts as a voltage source, providing a large DC output voltage to the load. Students also carry out LT-spice simulation to fully understand the circuit operating principle. Fig. 3 shows the fundamental operating principle of the whole circuit.

Fig. 3 illustrates the current direction in a rectifying process.

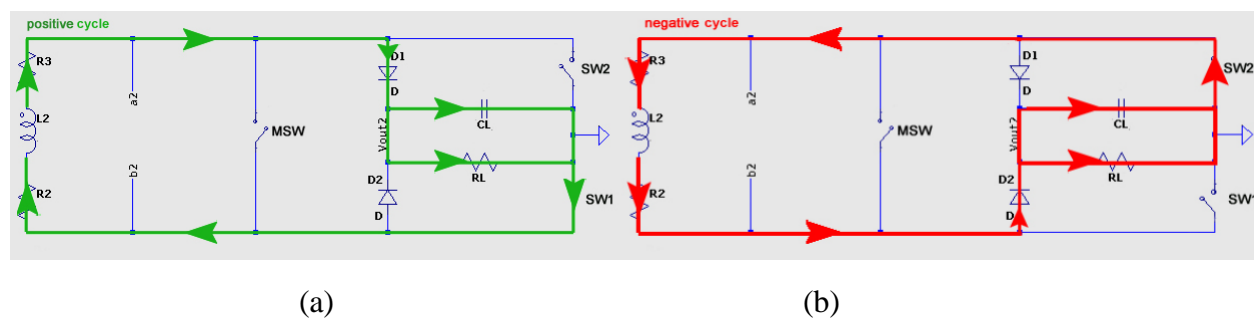

Figure 3. LTSpice simulation, schematic and simulation results. (a) and (b) stand for opposite voltage/current polarity

*Phase 2: Improve the existing circuit.* Once students are familiar with the circuit's operating principle, they were asked to optimize the circuit, following the flow illustrated in Fig. 4. Eagle was used for the schematic and layout development. The schematic is redeveloped and further simplified. Creation of the layout necessitates careful planning. Parasitic effects are detrimental between certain components and negligible between others. In this phase, a new printed circuit board is designed.

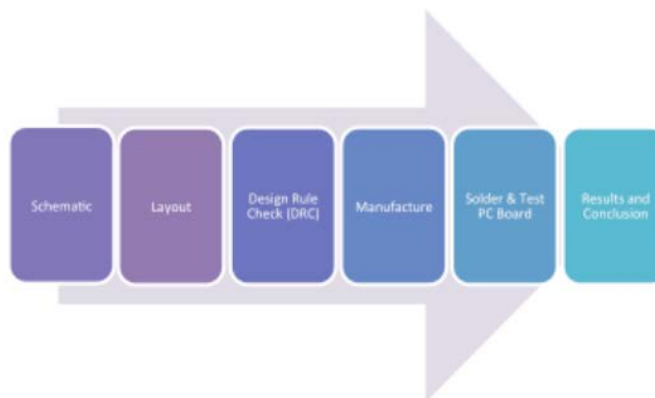

Figure 4. The flow chart of making a printed circuit board.

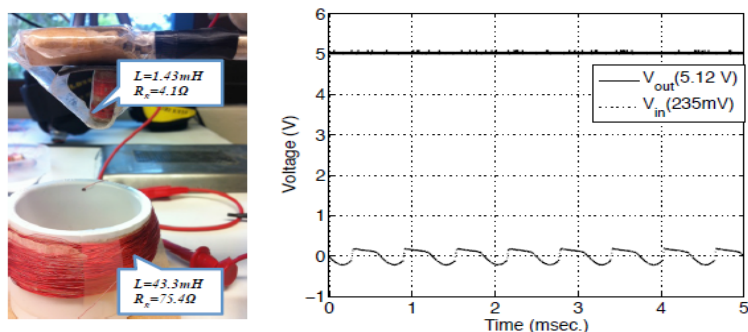

Figure 5. (a) Measurement setup (b) Output voltage vs open circuit input voltage for the 1.43 mH coil with a conversion ratio of 21.8 output-input voltage

*Phase 3. Characterize the improved AC-DC boost converter.* The wireless power is generated with a coil, as seen in Fig 5(a). The transmitter coil is composed of copper wire wrapped about a PVC pipe of radius 2.825cm and a length of 4.000cm. The coil possesses an inductance,  $L$ , of 43.3mH and an internal resistance,  $R_s$ , of 75.4 $\Omega$ . It is hooked to a power supply that provides the coil with an AC voltage of a square waveform. The receiver coil is comprised of a copper coil wrapped about a ferrite rod of radius 2.5mm and length 20mm. The output voltage is measured using a receiving coil with 1.43mH inductance and 4.1  $\Omega$  resistance, as shown in Fig. 5(b). The circuit successfully boosts the input AC power with very low voltage to 5V DC power.

### Project Assessment and Future Improvement

Students who participate in the research on the design and optimization of an innovative power harvest device for miniaturized biomedical implant are very enthusiastic about the selected project, and highly motivated to learn electrical engineering. A survey is conducted after the internship to obtain the assessment of the project. The survey includes four questions that students were asked to rate their level of agreement with each question in a five point scale (1 – Not at all useful; 2 – A little; 3 – Some; 4 – Quite a bit; 5 – A lot), and three questions that students were asked to write their comments. The survey is conducted anonymously so that students are able to express their opinions freely. Students in the internship program are very enthusiastic about the research, although they just finished engineering preparation courses in the community college and are ready to transfer to a four-year college. Table 1, which extracted from the survey, clearly indicates students' enthusiasm towards the research. Table 1. Students' responses on the results of the internship program (Question: As a result of your participation in the program, how much did you learn about each of the following?)

Activity	Average Rating
Performing research	4.94
Designing/performing an experiment	4.88
Creating a work plan	4.81
Working as a part of a team	4.81
Writing a technical report	4.63
Creating a poster presentation	4.69
Making an oral presentation	4.81

When asked the question “what do you like most about the NASA CIPAIR Internship

Program?”, Electrical Engineering students’ responses are: “The opportunity to gain hands on experience and write a research paper with the potential for publish. Also, as a person who experiences anxiety with presentations, it has helped me improve my presentation skills for future work.”, “The subject that we were working on the team work and the final presentation”, “It was a really good learning experience overall. There were many skills that I gained such as presenting, soldering, writing and many other things that are important to know in the engineering field. Not all of these are taught in the regular school curriculum which is unfortunate. I also liked working in groups, the work became easier to tackle and forming plans was very important to stay up to date with timelines”. Students who participate the program are very committed in electrical engineering. Students put down comments like: “I like that I got to learn about what it would be like doing electrical engineering, a very reputable and challenging career path. I can go as far as to say that I liked being in the lab and getting to work with others on a team in electrical to the point where I am strongly considering electrical engineering as a major. I really enjoyed collecting data and being able to communicate with other professionals in electrical engineering, it feels so gratifying. I liked being on NASA's campus and learning more about their career paths with engineering in general, I also enjoyed learning about what a lot of the professors thought about certain engineering ideas like power efficiency, nuclear engineering, and other government applications involved in engineering that expanded my horizon and level of thinking.”, and “It has been the best summer I have had! I have gained so much experience and I will be applying for more internships next summer. This program reinforced my decision to keep working on getting my B.S. on electrical engineering and go on to graduate school”. These comments show students are interested in electrical engineering.

### Summary and Conclusion

The summer internship supported by the NASA CIPAIR program has dramatically improved the underrepresented minority students’ understanding of the fundamental electrical circuit theory. Students who participated in the program have indicated that the program has not only enhanced their circuit knowledge, but also exerted a positive influence in their future STEM learning and practicing.

### Acknowledgement

This project is sponsored by NASA Office of Education through the Curriculum Improvement Partnership Award for the Integration of Research (CIPAIR), Grant Number NNX10AU75G.

### References

1. J. Vandewalle, in *Electrical and Electronics Engineering (ELECO), 2011 7th International Conference on*, 2011), p. II.
2. R.A. Amarin, K. B. Sundaram, A. Weeks, and I. Batarseh, in *Global Engineering Education Conference (EDUCON), 2011 IEEE*, 2011), p. 792.
3. J.P. Holdren and E. Lander, (President's Council of Advisors on Science and Technology, Washington, DC. , 2012).
4. H. Jiang, D. Lan, D. Lin, J. Zhang, S. Liou, H. Shahnasser, M. Shen, M. R. Harrison, and S. Roy, in *34 Annual International Conference of the IEEE Engineering in Medicine and Biology Society EMBC2012*, San Diego, 2012), p. 1675.
5. H. Jiang, B. Lariviere, D. Lan, J. Zhang, J. Wang, R. Fechter, M. Harrison, and S. Roy, in *Biomedical Wireless Technologies, Networks, and Sensing Systems (BioWireless), 2014 IEEE Topical Conference on*, 2014), p. 1.

## **Electronic Laboratory Notebooks versus Paper Laboratory Notebooks: A Comparison of Undergraduate Experimental Engineering Laboratory Submissions**

Mary Cardenas  
Harvey Mudd College

### **Abstract**

Electronic Laboratory Notebooks (ELNs) are computer-based solutions for creating, storing, retrieving, and sharing electronic files. Such electronic records are now considered equivalent to paper-based records, when it comes to patent filing as well as other legal and technical issues. Advantages of ELNs include the ability to search electronically; electronic linkage and storage of potentially large data files (including newer types of electronic files, such as video); and increased accessibility and collaborative functions. A number of different software solutions are available, usually grouped by technical field and potential application of the work. In this paper, literature on Electronic Laboratory Notebooks is summarized, with a particular focus on applications to undergraduate laboratory work. An ELN system consisted of a learning management platform (Sakai) and typical word processing and spreadsheet-based programs has been adopted at Harvey Mudd College for use in a sophomore-level experimental engineering course. The ELN system and the experimental engineering course are described in detail. Four semesters of undergraduate student work from this experimental engineering course were examined: two semesters of student lab work submitted in the form of the usual paper laboratory notebooks (PLN), and two semesters of electronic submissions (ELN.) Examples of student work are presented, with a focus on assessment of good laboratory notebook practice. In particular, recording of raw data and presentation of test rig schematics were assessed. Although expectations were that raw data would be easier to record and store using the ELN, no major differences were seen between PLN and ELN student submissions. Some inclusions of photographic and video media were seen in ELN student work, but in general, students did not seem to be taking advantage of the electronic medium. Faculty experiences with the management and grading of the student laboratory notebooks is discussed. This includes storage and access of laboratory notebooks, as well as issues of grading and release of scores to the students. Faculty and grader access was improved when using the electronic system, but there was significant annoyance and resistance due to the idiosyncrasies and peculiarities of the learning management platform, as compared to the simplicity of paper laboratory notebooks.

### **Background**

The Electronic Laboratory Notebook (ELN) is defined as a computer-based solution for creating, storing, retrieving, and sharing electronic files. Electronic records such as ELNs are now considered equivalent to paper-bound records, in terms of patent filing and intellectual property rights<sup>1</sup>. Advantages of ELNs include the ability to search electronically; electronic linkage and storage of potentially large data files (including newer types of electronic files, such as video); and increased accessibility and collaborative functions. A number of different software solutions are available, usually grouped by technical field and potential application of the work. ELNs are much more common in industry, compared to academia; ELNs are rarely used in undergraduate



science and engineering education, although their use is beginning to be explored. In particular, the pharmaceutical industry has adopted ELNs<sup>2</sup>.

### **Laboratory Notebook Practices: Paper versus Electronic**

One of the most important pieces of information regarding good lab book practice is the timestamp. For paper laboratory notebooks (PLNs), which have been used for centuries to document scientific and engineering endeavors, the timestamp indicated a dated entry, in ink, which is never to be altered. For electronic storage of information, the timestamp is called metadata, or meta-information, and often refers to tagging a computer-based file (perhaps containing raw data, or information about experimental settings) with the time the file was modified. In industrial work, meta-information can also include the name of the author of the “entry.” In addition to timestamps, a typical entry in a laboratory notebook is a sketch or schematic indicating the test set-up or rig. For PLNs, this can be a hand-drawn figure directly entered in ink onto the paper. Related to the test rig schematic are equipment lists. Good laboratory notebook practice emphasizes describing both the test set-up and the equipment used in an experiment. For PLNs, quickly sketching on paper has proven to be a simple solution. Hand-written equipment lists can be tedious to inscribe, but has been a staple of PLNs.

These two types of entries can be incorporated into an ELN. There are software solutions to capture sketches (which can be saved and either linked into an ELN, or inserted into a document as an image) but one would need the particular software and a computer with touchscreen inputs. Equipment lists could simply be typed and included in a document or saved as a file and linked into an ELN. Raw and processed data are a third type of entry common to laboratory notebooks. For PLNs, raw data was often handwritten into the notebooks, and the date of the entry was noted. Over the past few decades, it became more common to see cut-and-pasting of data which had been entered directly into a computer spreadsheet, and printed on paper so that it could be taped or glued into the PLN. Although this was likely not a best practice, it has become very common. Processed data were generally presented in the PLN by showing a sample calculation (changing the raw data into whatever useful processed information necessary for the experiment.) Typical examples include running a measured voltage through a calibration equation, converting units, or calculating non-dimensional numbers from measured quantities. Once sample calculations were presented, tables or plots of the processed data were typically entered into the PLN. Although hand-graphing of data was done in the past, and can obviously still be performed, computer-based graphing programs have become ubiquitous, and PLNs often contain printed graphs and tables that have been pasted or taped into the PLN. Obviously, direct linking/insertion of computer-generated graphs and tables is one way to implement data tables and graphs into an ELN, and most computers already include software that will produce tables and graphs.

### **ELNs in Undergraduate Education**

The following section borrows heavily from Cardenas (2014)<sup>3</sup>. There are a few examples in the literature regarding ELNs in undergraduate education. Meyer et al described the use of an HTML-based laboratory notebook (design journal) in a capstone digital systems course at Purdue<sup>4</sup>. Assessment of the students’ laboratory notebooks showed improvement when two tablet PCs were allocated per team, but the students reported that the HTML format was a hindrance to maintaining their notebooks, and indicated a preference for a commercial ELN

solution. The authors noted that many of the student teams “took advantage of (and put to good use) the ability to post digital pictures of prototyping setups, provide hyperlinks to all their device datasheets, post their latest schematics and software listings for evaluation, and post video clips of their project in action (as verification of their project success criteria).”

The use of course management systems (CMS) such as Blackboard<sup>5</sup> for educational applications of ELNs was reported. CMS are web-based software packages with many functions designed to facilitate the delivery of on-line course content; support the electronic interaction between instructors and students; serve as a repository (a dropbox) for student work; and provide gradebook functions which allows instructors to enter grades, and students to receive the grades and instructor comments. Chat, blog, and forum functions are usually a part of a CMS. Woerner used a combination of common academic software and the Blackboard online course management system as an ELN in an advanced undergraduate Chemistry lab at Duke University<sup>6</sup>. The students used Microsoft Word and graphing software to ‘create’ their lab notebook components. Once their work was written, the students submitted their electronic files into the dropbox of Blackboard. Woerner reported that the students found typing equations to be time-consuming, and noted that pre-lab work went very well using the course management system.

Hesser and Schwartz<sup>7</sup> described a General Chemistry course at the University of New Haven that used iPads in classroom and labs. Blackboard Mobile was used to post the assignments, and the students used iPads to record the laboratory and course content. In particular, drawing apps were used; annotation of pdfs and photos was done; and the collected lab data was imported to the iPad for analysis. Students reported that the iPad was difficult to write with--this is consistent with the idea that iPads are good for consuming content, but not necessarily useful for creating content, or inputting larger amounts of text and data--but that their skills got better with time. Another concern from the students was the inability to look at more than one page of data at a time, especially when needing to compare sets of data. The authors noted that the iPad was inexpensive compared to a laptop-based solution and believed that the practice using digital-based solutions was an advantage for the students.

### **Commercial ELN Solutions**

There are many commercial ELN solutions available. The Scientist<sup>8</sup> presents a good summary, including cost figures from 2010 (costs can range from \$0 to tens of thousands of dollars with the higher cost figures representing ELN solutions specific to the pharmaceutical industry.) In this section we will focus on two commercial ELNs which may be appropriate for use in an undergraduate education environment.

iLabber<sup>9</sup> is an ELN which allows a user to create an electronic document of an experiment, including timestamping, locking, and digital signature functions. Users can input text, images, pdfs, excel files, etc. A particularly interesting feature that could be useful for undergraduate education is the option for using templates, rather than opening a ‘blank’ experiment. These templates could include placeholders for sections such as experimental set-up, equipment lists, and so on. Although we hope as educators that we don’t always need to give the students a recipe book, perhaps in frosh laboratory courses, or in early labs in more-advanced courses, one could use the template as a way to remind the students of best laboratory notebook practices. Figure 1

shows a screenshot of iLabber. The toolbar on the left-hand side indicates the types of files that can be added to the electronic experiment document.

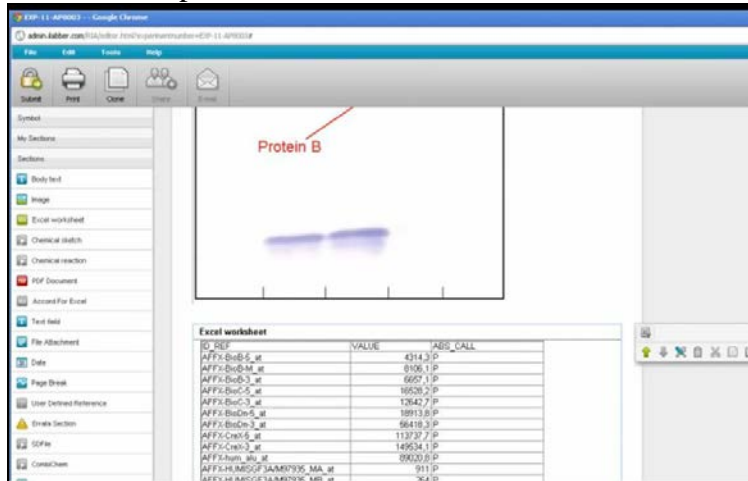

Figure 1. Screenshot from iLabber<sup>10</sup> including a figure and Excel worksheet.

eCAT<sup>11</sup> is an ELN with similar functions to iLabber, but has additional file structuring capabilities. In particular, a user may link records and files from their own server, as well as link files from the web. eCAT was one of the ELNs used in the Electronic Lab Notebook pilot study<sup>12</sup> at the University of Wisconsin, Madison. This study involved academic researchers, mostly graduate students, in fields of science, engineering, and medicine. A significant finding in the report is that the users found two features of most use: the ability to add data and link files. The simple drawing tools in eCAT were not deemed very useful by many of the users. Although the file structuring functions of eCAT may not be necessary for simpler undergraduate laboratories, given that practicing engineers found this useful, eCAT may be a good option for upper-level laboratories and students involved in undergraduate research.

### Sophomore-Level Undergraduate Engineering Laboratory

During the 2011-2012 academic year, we implemented a transition from paperbound laboratory notebooks to electronic laboratory notebooks in an undergraduate experimental engineering course. Experimental Engineering (E80) at Harvey Mudd College is a sophomore-level, semester-long course, involving multiple experiments covering a number of engineering disciplines. The objectives of the course are to teach basic instrumentation and measurement techniques; good lab notebook practice; technical report writing; analysis and presentation of data; the usage of experimental results for engineering design purposes; and the beginnings of professional practice. The course explicitly requires learning in multiple disciplines but directs all of the experiments to a final goal: to build, instrument, and fly a small rocket; and analyze and report on the data collected during the flight. The course walks the students through modeling of the rocket performance based on weight, vibration, strength, drag, and engine test data; and the implementation and configuration of an instrument package and data acquisition system. The students have various objectives and constraints related to their scientific goals and project budget; therefore they are required to choose from among alternatives when designing their sensor package. Each student team builds and instruments a rocket, and test flights are made where the students collect experimental data. If weather conditions and the state of the vehicle

permit (i.e., the rocket wasn't damaged or destroyed during flight or recovery), each student team may get data from up to six flights.

The course format consists of two large lectures, and two three-hour laboratory sessions per week. Course enrollment over the past five years has ranged from approximately 60 to 80 students per semester. These 60-80 students are divided into four sections of up to 20 students. The typical staffing for the course is one professor per 20 students. While this faculty-student ratio is considerably higher than that of most engineering programs, it is consistent with Harvey Mudd College's approach to undergraduate education. The students are placed in teams of four students, and perform their laboratory work as teams. The laboratory experiments in the course span various engineering disciplines. Electrical engineering and electronics is emphasized, since modern instrumentation and data acquisition relies heavily on those disciplines. Mechanical and aerospace engineering topics are also fundamental to rocket flight; in particular, fluid mechanics and trajectory modeling are important. The students are introduced to the National Instruments myDAQ<sup>13</sup> data acquisition system, and LabVIEW assignments are assigned to help the students learn its use.

The students learn basic electrical measurements and design/test an op-amp-based low-pass (anti-aliasing) filter. This filter can be used during the data acquisition phase of the launch. In order to prepare the students for the various instrumentation tasks, there are laboratories focusing on data acquisition (pressure, temperature, acceleration, and rotation-rate measurements) and the use of modern computer-based data-acquisition systems such as LabVIEW along with the myDAQ device. In order to develop the students' understanding of wind tunnel measurements, there is a lab involving drag measurements and calculations for standard shapes and the model rocket. The students also build on their introductory physics knowledge to model vehicle kinetics and flight trajectory, and also perform static engine tests on the model rocket motors to measure the thrust curve.

### **Our Implementation of ELN**

Although there are many commercially-available ELNs, most have been aimed at satisfying the requirements of the pharmaceutical and biotech industries, and tend to include more extensive functions than those needed for an undergraduate laboratory course. For our initial foray into ELNs, we took the approach of using an already-existing course management platform (Sakai) as the electronic repository for the students' work, and allowed the students to submit their work using Microsoft Office Suite or similar word-processing tools. We urged them to investigate how to use the timestamp function in both Excel and Word. Sakai<sup>14</sup> is the free, open source course management and collaborative learning tool. It is an alternative to a traditional commercial course management system such as Blackboard. Collaboration and sharing of materials is a primary objective of Sakai. Students, staff, and faculty all have access to the system, and courses are automatically populated with enrolled students at the beginning of each semester. Sakai includes many functions, including blogs, chat rooms, forums, messages, podcasts, syllabus, and web content. For our ELN application, we used the "Assignments", "DropBox" and "Resources" functions. These functions allow users to store, manage, and share files online. File types can include documents, videos, and images. Citation lists can also be created in Sakai. Files 'dropped' into folders on Sakai are timestamped; faculty can also set assignment deadlines, and Sakai will report if a submission was turned in late. The students used Sakai to turn in work

related to their lab notebooks; faculty and teaching assistants used Sakai to access the students' work in order to grade and release comments back to the students.

The primary reason for switching from PLNs to ELNs was because we believed that electronic recording would be the typical format students would be expected to use in industrial or research contexts, once they have graduated. We expected that the ELN format might improve students' written communication, given students more practice in submitting polished writing, rather than the hasty scribbling we sometimes see in the PLNs. We thought the electronic format would result in increased use of images and videos to document lab set-ups and operation. We were curious to see if the students would submit their spreadsheet files as documents reporting raw data and the processing of such data. These spreadsheets could be dropped into the "Resources" folder of the Sakai course management system, but this option was not suggested to the students. There were faculty concerns about students losing the ability to quickly sketch a schematic, although some instructors argued that the clever students could still sketch on paper, and then scan (or photograph) and insert the image into their document.

### Examples of Student Work: PLN and ELN

We assessed laboratory notebook submissions of raw data, test set-up schematics, equipment lists, and comparison of experimental data to literature values. In this paper, we will focus on the first two (Cardenas<sup>4</sup> describes the rest of the assessment.) In assessing presentation of raw data in the lab notebooks, an excellent submission would include raw (not processed) data, with correct units labeled, and multiple trials. It was typical to see tables that showed only processed data, and data without any units whatsoever. The least acceptable submissions had no raw data, or included placeholders for raw data, but did not fill in the tables. Figure 2 shows an example of an entry in a PLN from E80. This is the typical 'placeholder' for raw data: the students knew they needed to enter raw data, and created a table for the raw data, but neglected to actually enter the data. We know they took the data, because processed data tables and graphs show up in their notebook.

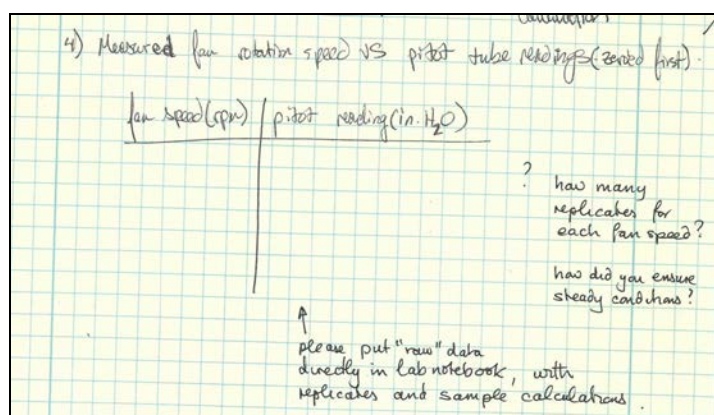

Fig. 2. Missing raw data in a PLN. Grader comments are seen on the right and bottom. A better example of a raw data table is shown in Figure 3. Here the students present the fan speed data; the raw measurement of pressure; and the processed data indicating velocity of the air in the wind tunnel.

Submission of raw data in ELNs was similar to that seen in the PLNs, although we didn't see any raw data placeholders; when raw data were not presented, they were simply absent from the document (ELNs were handed in .doc or .pdf formats.) Figure 4 shows a raw data table from an

ELN; the students did not pay attention to the document formatting, so the table was split across the page break, and the units were not specified for all the data.

$\pm 0.05$ Hz Fan Rotation Rate (Hz)	<del>Pa - P<sub>2</sub></del> Pa - P <sub>2</sub> (in H <sub>2</sub> O)	Wind speed ( <del>m/s</del> ) (m/s)	
0	0	0	
10	0.14	8.392	9.622
5	0.03	3.885	3.991
9	0.12	7.770	7.982
15	0.35	13.074	13.44
18	0.51	16.02	16.46
21	0.70	18.77	19.28
25	1.01	22.54	23.16
29	1.37	26.25	26.97
34	1.91	30.00	31.85
38	2.37	34.93	35.47
42	2.98	38.72	39.78
7	0.07		6.096
13.5	0.29		12.41
20	0.67		18.86
27	1.25		25.76
34	1.99		32.57
40	2.76		38.28
46	3.85		45.21
50	4.72		50.06
38.5	3.10		40.57
33	1.87		31.51
26	1.15		24.71
19.5	0.63		12.22

Figure 3. Data table showing raw and processed data in a PLN.

RPM	Test1	Test2	Test3	Test4	Average	Std. Dev.
E80 Lab 5: Wind Tunnel -						
500	0.056 (498)	0.057 (503)	0.056 (501)	0.056 (501)	56.25 Pa	0.43
1000	0.238 (1001)	0.241 (1001)	0.238 (997)	0.240 (1001)	239.25 Pa	1.30
1500	0.560 (1502)	0.560 (1499)	0.564 (1503)	0.563 (1500)	561.75 Pa	1.79

Figure 4. Example of ELN data table with missing units and poor formatting.

Figure 5 shows a better example of a raw data table from an ELN. The figure shows some of the text from the ELN, as well as the data table showing raw (not processed) data, with units clearly and correctly labeled.

### 5.2 Wind Tunnel Calibration

The data collected using the pitot tube and the wind tunnel are seen in Table 8. Data was taken for speed controller settings from 0 to 75, but the pitot tube readings from the controller settings of 0 and 5 were zero and thus failed to produce meaningful results. Two trials of data were collected, one with increasing RPM and one with decreasing RPM to ensure reproducibility.

Speed Controller Setting	Fan Speed (RPM)	Pitot Probe Reading (in. H <sub>2</sub> O)	Test Section Airspeed (mph)
10	64	0.00	0.00
15	198	0.01	4.51
20	411	0.06	11.05
25	601	0.16	18.04
30	783	0.30	24.71
35	971	0.48	31.25
40	1134	0.66	36.65
45	1289	0.87	42.07

Figure 5. Data table from an ELN showing raw data and units.

We also assessed the students' ability to describe the test set-up in their laboratory notebooks. The best examples include a sketch or picture of the test set-up, with equipment clearly labeled. For both ELNs and PLNs, common mistakes included presenting incomplete descriptions of the set-up, and neglecting to describe the setup whatsoever. Although we expected to see more hand-drawn sketches of test set-ups in the PLNs, occasionally students sketched on a piece of paper, and then scanned that and pasted the scan into their paper notebook. We also expected to see more photos included in the electronic versions, but the most common submission in both the PLNs and ELNs was no description of the test set-up. This is a significant deficiency that we need to address in future versions of the course.

Figure 6 presents a rudimentary sketch from students' PLN. Figure 7 shows a much better sketch, also from a PLN. Figures 8 and 9 show photos of the actual test set-up that students presented in an ELN. Although we did expect that students would use the ability to easily include photos in their electronic versions, it was not commonly seen. Again, the most common submission was no description of the test set-up.

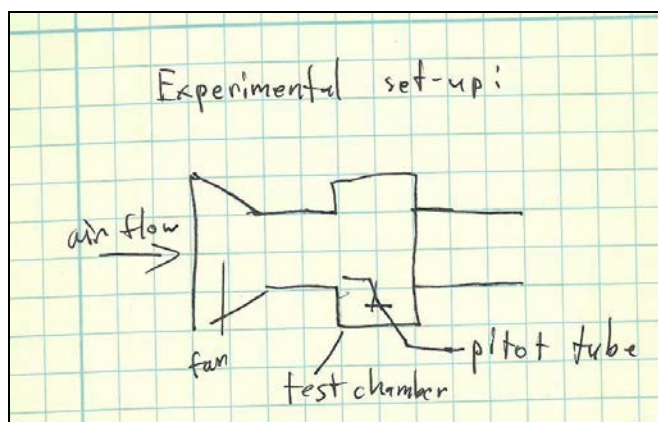

Figure 6. Rudimentary sketch of the test set-up from a PLN.

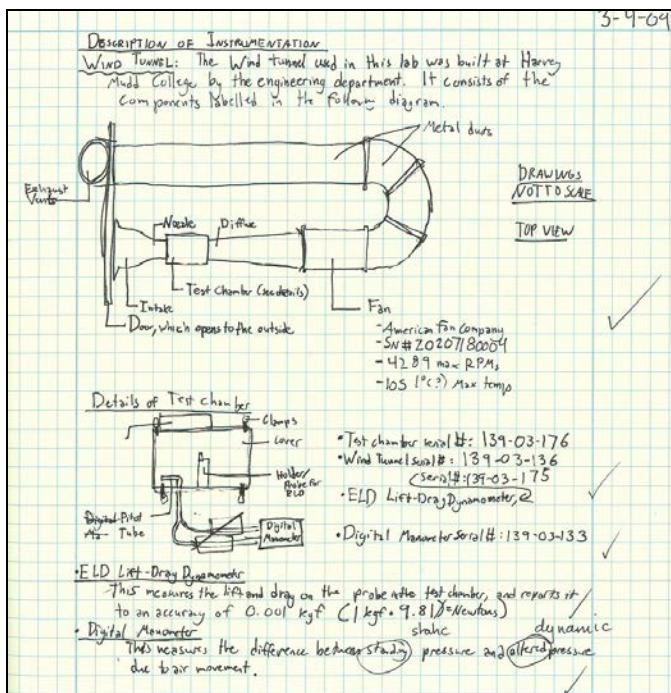

Figure 7. Much better hand-drawn sketch of the test set-up in a PLN.

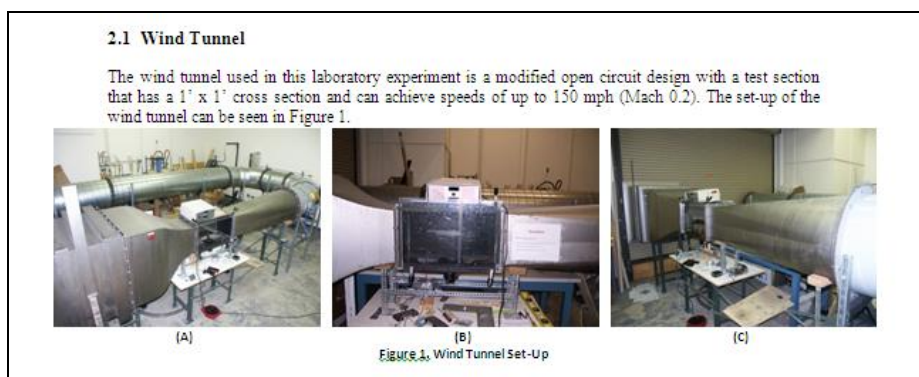

Figure 8. Photos presented in the description of the test set-up in an ELN.

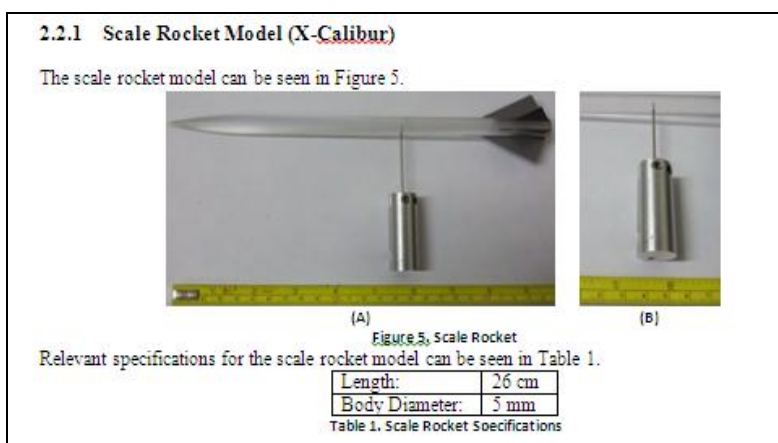

Figure 9. ELN submission of photos presenting equipment used in the wind tunnel lab.



## Discussion

Although we expected to see differences in the students' submitted laboratory work, once moving to the electronic laboratory notebook format, these differences did not manifest in the areas we assessed. Students did not commonly use the electronic format to include more images in their notebooks; they only rarely submitted raw data in spreadsheet form to the dropbox; electronic 'links' were rarely seen as part of the ELNs; and video evidence was generally not submitted. At the beginning of the course, the only suggestions we gave the students regarding ELNs was that timestamping was important. In future offerings of the course, we suggest increased instructor vigilance in reminding students of the various functionalities of Sakai; in particular suggesting that students can link video files to their ELNs, or use their mobile phone cameras to document test set-ups.

The students' notebooks showed major weaknesses regarding the inclusion of test set-up schematics, both in the paper form and the electronic form. It is not clear whether the use of ELNs alone will improve reporting of schematics; significant and sustained encouragement and inducement from the instructors is likely to have more impact than any changes in notebook format. Although some electronic devices allow sketching using a stylus, drawing by hand on paper still seems easier. As mentioned earlier, clever students could sketch on paper, and then scan or photograph the sketch in order to include it in their ELN, but this was not commonly seen. If we want to see this done, we will likely have to explicitly require it of the students. It should be noted that many students have been trained that there are significant differences between a 'lab report' and a 'lab notebook'. The course website explicitly asked for the students to submit a lab report, and therefore it is possible that students did not submit raw data because they have been told that lab reports do not include raw data (although other sections of the web site explicitly request submission of raw data.) Previous versions of this course at our institution have not made a clear distinction, although those were all paper-based, which may have steered students towards the 'lab notebook' mindset. Again, explicit instructions on the instructors' parts could make a difference here. Since the outcomes assessed were not able to distinguish differences between the electronic and paperbound notebooks, future work should be done to assess learning outcomes that may be able to identify differences between the two media. These could include examination of students' perceptions between the types of notebooks; time spent inputting data and text; quality of written work; and the ability to access their work outside the laboratory.

## Implementation: Challenges and Successes

The course management system, Sakai, has its detractors, including some of the faculty teaching this course. It is possible that there may be instructor "push-back" if these instructors are asked to sincerely recommend increased Sakai usage by students, even though the system is in wide use on campus. If students submit other types of files (spreadsheet-based data files, video files, etc.), students would drop those files into the "Dropbox" portion of Sakai, and their ELNs would be submitted into the "Assignments" folder, which is a completely different part of the system. A good ELN would allow linking between these files, but it does not seem to be a function of Sakai at this point. A course management system or commercial ELN that makes uploading and linking various files is recommended, given that expecting faculty to hunt for these additional media types on Sakai may be an unreasonable request.

Initially, students had difficulty with submitting their work to Sakai. A common occurrence was seen with submissions of Microsoft Word documents; some documents lost all formatting and equations once submitted to Sakai. A workaround for this was simply to save the Word document as a pdf, and upload the pdf. Another unknown bug was that multiple or duplicate files were often seen in the students Assignments folder; this was not a major problem, but it was strange. Submission of work was often recorded as being late by Sakai; again it was not clear if the server clock was slightly off, or if students really were submitting their work a minute or two late. Students often responded to the notification of late submission by sending multiple emails to the instructors, insisting that they had submitted the work on time. The lab notebooks were graded by faculty and by teaching assistants (the teaching assistants were upper-class engineering students who had previously taken the Experimental Engineering course.) The grading process was simplified by the use of the ELNs, due to the ability to access the students' work via networked computers, as opposed to grading PLNs, where the graders physically remove the lab notebooks from the lab (thus making the notebooks unavailable to other graders, and to the students themselves.) Although some faculty had difficulty with accessing the ELNs from Sakai, this was solved by making sure experts in Sakai (for example, administrative assistants in the departmental office or other faculty) were available to download the students' work for those instructors.

Regarding the claim that the ability to easily search ELNs is a huge asset, we found that having the work stored on Sakai made it much easier to archive and search, especially compared to manually searching through hundreds of paper-bound notebooks. The PLNs needed to be found and then brought out of storage on a hand cart, and occupied a physical volume of  $\sim 2 \text{ m}^3$ . Having access to the students' notebooks in an electronic form made the research done in this paper much more convenient. Although the students' ELNs were not centrally located in a single folder, it was not too much work to organize the files into a more convenient file structure, and although the file formats were not consistent, it was still possible to do a reasonable electronic search of these files.

## Conclusions

The "dream" ELN would include seamless communication between various instruments, data acquisition systems, and electronic storage. As noted in the literature<sup>15,16,17</sup>, given the variety of experimental systems, no single ELN solution exists that will automatically work with a custom experimental set-up. However, better ways to link, store, and organize various file types using a course management system would improve the implementation of an ELN in a lab-based course. Since ELNs are likely a new experience for most students and faculty, explicit requirements or marked suggestions regarding their use are likely necessary. For example, strongly suggest to students that test set-ups be sketched (and scanned) or photographed, and then included in their Word file and/or electronically stored and linked to their ELN. Give multiple reminders that raw data need to be recorded in their spreadsheet programs, and those files uploaded to the course management system as part of their ELN. Depending on the instructor objectives regarding laboratory templates, using a commercial ELN that explicitly lays out the recommended notebook sections could be one way to remind students what they are expected to report from their experiments. Clarity on the differences between a lab report and a lab notebook would do much to alleviate potential student confusion. It may also be necessary to make sure instructors

have assistance in learning and navigating the ELN software and course management systems, so that the tools do not interfere with the delivery of course content and assessment of student work.

Using the course management system as a means of implementing an ELN in the experimental engineering course improved the instructors' ability to access, grade, and search the students' work. Archiving these lab notebooks will only require electronic storage (although if we decide to keep these for decades, we will need to be mindful of keeping the files in a readable format). In our assessment of four semesters of student work, we saw no marked difference between work submitted using ELNs versus PLNs when we assessed submission of raw data and inclusion of test set-up. However, further assessment should be done to determine if the quality of written communication and other learning outcomes were affected by the use of ELNs.

### Bibliography

1. <http://accelrys.com/micro/notebook/documents/eln-legal-issues-sandercoc.pdf> accessed 12/27/2013
2. Giles, Jim. (2012). Going Paperless: The Digital Lab. *Nature*, 481 (7382), 430-431.
3. Cardenas, M. (2014) An Implementation of Electronic Laboratory Notebooks (ELN) Using a Course Management System Platform in an Undergraduate Experimental Engineering Course, ASEE National Conference, Indianapolis, IN, 2014.
4. Meyer, D. G., et al. (2008). Tablets for Timely Design Documentation. Proceedings of the 2008 American Society for Engineering Education Conference.
5. <http://www.blackboard.com/> accessed 12/31/2013
6. <http://acscinf.org/docs/meetings/230nm/presentations/230nm67.pdf> accessed 10/11/2013
7. Hesser, Tiffany L.; Schwartz, Pauline M. (2013). iPads in the Science Laboratory: Experience in Designing and Implementing a Paperless Chemistry Laboratory Course, *Journal of STEM Education: Innovations and Research*, v14 n2 p5-9 Apr-Jun 2013
8. <http://www.the-scientist.com/?articles.view/articleNo/28961/title/Digital-Upgrade/>, accessed 01/24/2014
9. iLabber, <http://contur.com/home/>, accessed 01/24/2014
10. Experiment Editor in iLabber, [https://www.youtube.com/watch?feature=player\\_embedded&v=1Cpz-U\\_yOjI](https://www.youtube.com/watch?feature=player_embedded&v=1Cpz-U_yOjI), accessed 01/24/2014.
11. eCAT, <http://www.researchspace.com/electronic-lab-notebook/index.html>, accessed 01/24/2014.
12. Electronic Lab Notebook Pilot at the University of Wisconsin-Madison, [http://academictech.doit.wisc.edu/files/ELN\\_pilot\\_report\\_UWMadison.pdf](http://academictech.doit.wisc.edu/files/ELN_pilot_report_UWMadison.pdf), accessed 01/24/2014
13. <http://www.ni.com/mydaq/> accessed 12/31/2013
14. <http://www.sakaiproject.org/> accessed 12/30/2013
15. Klokmose, C. N. and Zander, P.-O. (2010). Rethinking Laboratory Notebooks. In proceedings of the 9th International Conference on Cooperative Systems (Aix en Provence, France, May 19 - 21, 2010). COOP2010.
16. K. C. Huynh-Ba and A. F. Aubry, (2000). *Am. Lab.*, (2000). 32, 13.
17. Colin L. Bird, Cerys Willoughby and Jeremy G. Frey, (2013). Laboratory notebooks in the digital era: the role of ELNs in record keeping for chemistry and other sciences. *Chem. Soc. Rev.*, 2013, 42, 8157--8175

## Laboratory Enhanced Education in Biotransport Phenomena through COMSOL Multiphysics

David Clague, Joshua Wilbur, Elizabeth Stasiowski, and Alyson Telford  
California Polytechnic State University, San Luis Obispo

### Abstract

Biotransport Phenomena, that is, the transfer of Fluids, Mass and Heat in physiological systems, is fundamental to Biomedical Engineering (BME). As a consequence, undergraduate and graduate BME curricula contain key courses in this area but, these courses tend to be mathematically intensive, and therefore it is difficult for students to visualize phenomena to gain the desired Engineering intuition necessary for design and problem solving. The logical solution to this educational gap is to include experimental laboratories; however, key aspects of Biotransport Phenomena, e.g., wall shear stress and diffusive processes, are difficult (or too time-prohibitive) to incorporate into a hands-on laboratory experience.

In the Cal Poly San Luis Obispo BME curriculum, a set of in-silico laboratory activities have been developed using an easy to use multi-physics Finite Element Package (FEA), COMSOL Multiphysics, to augment teaching Biotransport Phenomena. More specifically, in this upper division Biotransport course, there are six required FEA laboratories and one extra credit FEA laboratory. These laboratory exercises are designed to enable students to simulate and visualize key aspects of physiological Transport Phenomena. In this paper, the course laboratories are presented and explained in the context of the course goals and expected outcomes, and selected laboratories are presented in sufficient detail to demonstrate how students are able to perform in-silico experiments in a timely fashion and develop valuable experience and Engineering intuition in Biotransport Phenomena. In addition to gaining valuable Engineering intuition, the students develop some skills and gain experience in using COMSOL Multiphysics. Owing to the ease at which COMSOL Multiphysics permits coupled multi-physics in computations and simulations, this FEA package is gaining use in industry. Aspects of COMSOL Multiphysics relevant to education in the BME department at Cal Poly San Luis Obispo are also discussed.

**Introduction** Biotransport Phenomena can be a difficult subject to teach. The subject matter, bio-fluid mechanics and bio-mass transfer, in a physiological context adds extra difficulty to these already mathematically intensive courses. Prior to delving into these subject areas students require sufficient depth to acquire relevant Engineering skills and intuition. As a consequence, many Universities teach the various forms of Transport as individual, separate courses. At Cal Poly San Luis Obispo, however, we have developed a single, one quarter, 10 week, course that covers introductory bio-fluid mechanics and bio-mass transfer, both convective and diffusive transport, in the context of human physiologic processes. Given that Transport Phenomena is mathematically rigorous, a single quarter presents added time constraints to learn the necessary mathematical methods, and furthermore, based on pure mathematical results, it is difficult to visualize transport processes. With such limited time and challenges, it is challenging to achieve the ultimate learning objective of properly equipping students for design problems that involve Biotransport Phenomena.

An obvious approach to meet learning objectives is to develop a set of hands-on laboratories. At Cal Poly over the past 5 years, hands-on experimental laboratories have been utilized in the Biotransport Phenomena course; however, key laboratory exercises involving Diffusive processes, which were inherently slow and time prohibitive, extended beyond the allotted laboratory time limit. Additionally, finding and designing wet, hands-on laboratories to complement the flow of the lecture proved to be very difficult. So Cal Poly BME was faced with the dilemma of a) developing a set of complementary laboratories, b) compressing the Mathematical learning curve associated with Biotransport Phenomena, and c) helping students develop valuable Engineering skills and intuition in this key area of the curriculum. At Cal Poly, a set of Finite Element Analysis (FEA) laboratories were created to meet these constraints and challenges.

Before designing the FEA laboratories, it was necessary to select a suitable FEA package. The requirements set for such an FEA package include:

- Commercial availability
- Ease of use
- Ability to handle coupled physics
- Good visualization tools
- Compatibility with other Computer Aided Design (CAD) programs
- Industry relevance

There are only a few packages available commercially that meet these criteria, e.g., CFDRC ACE+ and COMSOL Multiphysics to name a few. Cal Poly selected COMSOL Multiphysics. This choice was based on the popularity of this package in the microfluidics community and the growing interest in the medical device industry. Additionally, COMSOL Multiphysics is very user friendly, and it has innate CAD tools that are sufficient for many relevant problems. For the purposes of the Cal Poly Biotransport Phenomena course, COMSOL Multiphysics provides an excellent approach to forming complementary laboratories to a rigorous lecture course. In the sections to follow the set of FEA laboratories are briefly described, selected results are presented and when appropriate, COMSOL Multiphysics results are compared with theory.

### **The COMSOL Multiphysics Laboratories: An Overview**

In the lecture portion of Bio-Transport Phenomena at Cal Poly San Luis Obispo, the following topics are covered: conservation principles, Starling flow, steady-state bio-fluid mechanics, diffusive and convective processes in various physiologic media and mass transfer coefficients, i.e., mass transfer through boundary layers. In parallel with these lecture topics, seven COMSOL Multiphysics laboratories have been developed to complement the lecture. It is important to note that the students typically have no experience with COMSOL Multiphysics when entering the course; hence, the first few laboratories are designed to familiarize students with COMSOL Multiphysics via simple, relevant simulations.

The first three laboratories exclusively cover fluid mechanics. The first lab is simply steady flow of a Newtonian fluid between parallel plates. Before the students perform the numerical experiment, they analytically solve for the average fluid velocity in the gap and for the shear stress at the wall. The second laboratory is used to introduce time-dependent pulsatile flow, using the same parallel-plates model in the first laboratory. While these flow configurations are

not physiologically accurate, the students do gain Engineering intuition, experience and confidence through the basic FEA and learn how to perform the desired post-processing to extract key information. With this foundation, students then characterize steady and pulsatile flow in cylindrical conduits representing blood vessels of various sizes. As with the two-dimensional case, students compare COMSOL Multiphysics results with exact theory.

Following the fluid mechanics laboratories, the students are exposed to pure diffusion and coupled convection-diffusion problems. More specifically, students develop models for a drug-eluting stent in an artery, transdermal drug delivery and tissue oxygenation. In the drug-eluting stent laboratory, students also learn how to perform axisymmetric analysis using COSMOL Multiphysics. Following this laboratory, students setup and study time-dependent transdermal drug delivery problem with a fixed initial drug patch. In this laboratory exercise, the students are able to visualize the depletion of drug in the drug patch, drug transport and concentrations in various layers of tissue as a function of time. Again the students learn how to utilize more advanced features associate with COMSOL Multiphysics. For the final required laboratory, students replicate the Krogh tissue cylinder and explore oxygen transport in tissue surrounding a capillary. This is also performed using an axisymmetric COMSOL Multiphysics model. Toward the end of the course, students are given the opportunity to perform an additional laboratory to recover lost credit and to learn how to apply the software to characterize a bio-reactor for tissue engineering.

For each laboratory, the students report their results by preparing a set of PowerPoint slides that includes a problem statement, system description, computational parameters, mesh description, results answering posed questions, conclusions and future applications. This reporting approach was patterned after how project team members in a National Laboratory setting might report their progress and findings to the project team during a project team meeting.

### **The COMSOL Multiphysics Laboratories: Selected Examples**

To illustrate how COMSOL Multiphysics complements the lecture, selected results from a few of the laboratories are presented below, namely:

1. Two-dimensional, steady-state, pressure-driven flow between parallel plates as compared to theory
2. Two-dimensional, pulsatile flow between parallel plates
3. Three-dimensional steady-state, pressure-driven flow in a cylinder compared to theory and
4. extension to pulsatile arterial flow
5. Two-dimensional axis-symmetric drug-eluting stent
6. Oxygen consumption in a three-dimensional Krogh tissue cylinder

#### **Laboratory Example 1**

Pressure-driven flow between parallel plates is a typical, initial computational study in fluid mechanics to compare numerical solutions with theory. In this straightforward flow configuration, students are given the average fluid velocity for an artery, arteriole and a capillary. From theory derived in the laboratory, students predict the necessary pressure drop over the length of each vessel type. The average velocity,  $(v_x)$ , and resulting expression for the pressure drop,  $(P_1 - P_2)$ , is given by

$$\langle v_x \rangle = \frac{h^2(P_1 - P_2)}{3\mu L} \quad (1)$$

and therefore

$$(P_1 - P_2) = \frac{\langle v_x \rangle 3\mu L}{h^2} \quad (2)$$

Here,  $h$  is the half-gap between the parallel plates, i.e., the vessel “radius”,  $L$  is the vessel length and  $\mu$  is the fluid viscosity. Furthermore, prior to averaging, the magnitude of the fluid shear stress can be found as

$$\|\tau_{yx}\| = \left| \frac{P_1 - P_2}{L} y \right| \quad (3)$$

where  $\|\tau_{yx}\|$  is the magnitude of shear stress acting in the  $y$ -direction due to flow in the  $x$ -direction<sup>1</sup>. Note also that  $P_1$  is the entrance pressure and  $P_2$  is the exit pressure, that is,  $P_1 > P_2$ .

After predicting the desired pressure drops and expected results, students set up and perform FEA of pressure-driven flow using COMSOL Multiphysics, specifically flow occurring in the  $x$ -direction between parallel plates separated by  $2h$ . A typical set of COMSOL Multiphysics results is given in Table I below.

Table 1. Comparison of COMSOL Multiphysics with theory for steady-state, pressure-driven flow between parallel plates.

2D Representation	Average Velocity			Wall Shear Stress $y = h$		
	Theory (cm/s)	COMSOL (cm/s)	% Difference	Theory (Pa)	COMSOL (Pa)	% Difference
Artery	30.0	30.1	0.333	1.080	1.084	0.370
Arteriole	0.780	0.782	0.256	1.080	1.082	0.185
Capillary	0.096	0.096	0.000	1.080	1.080	0.000

For each result presented in Table I, COMSOL Multiphysics mesh refinement was set to ‘Normal’. (The students are taught the necessity of a mesh refinement, but due to computing facilities limitations not all computational studies involved a mesh refinement component.) As can be seen above in Table 1, the average velocities and wall shear stresses predicted by COMSOL Multiphysics<sup>®</sup> were in excellent agreement with theory.

### Laboratory Example 2

Following this laboratory, students are introduced to pulsatile flow, the goal being to incrementally approach a more realistic model for blood flow in vasculature. To simulate pulsatile flow, students use a simple sinusoidal representation for pressure drop across the section of vessel, i.e.,

$$\Delta P(t) \approx \Delta P(1 + \varepsilon \sin(\omega t)) \quad (4)$$

Here,  $\Delta P$  is the pressure drop given in Eqn. (2) above,  $\varepsilon$  is a fraction between (0, 1], and  $\omega = 2\pi\nu$ , where  $\nu$  is the heart rate in beats per second. The magnitude of  $\varepsilon$  is estimated from a physiology text and depends on the vessel location in the vascular tree<sup>2</sup>. Human Physiology students learn how to incorporate this time dependent pressure drop into COMSOL Multiphysics

and characterize the maximum and minimum wall shear stresses in the vessel. It should be noted that pulsatile flow only applies to arteries and arterioles. Illustrative snapshots during the cardiac cycle are shown below in Figure 1 a & b.

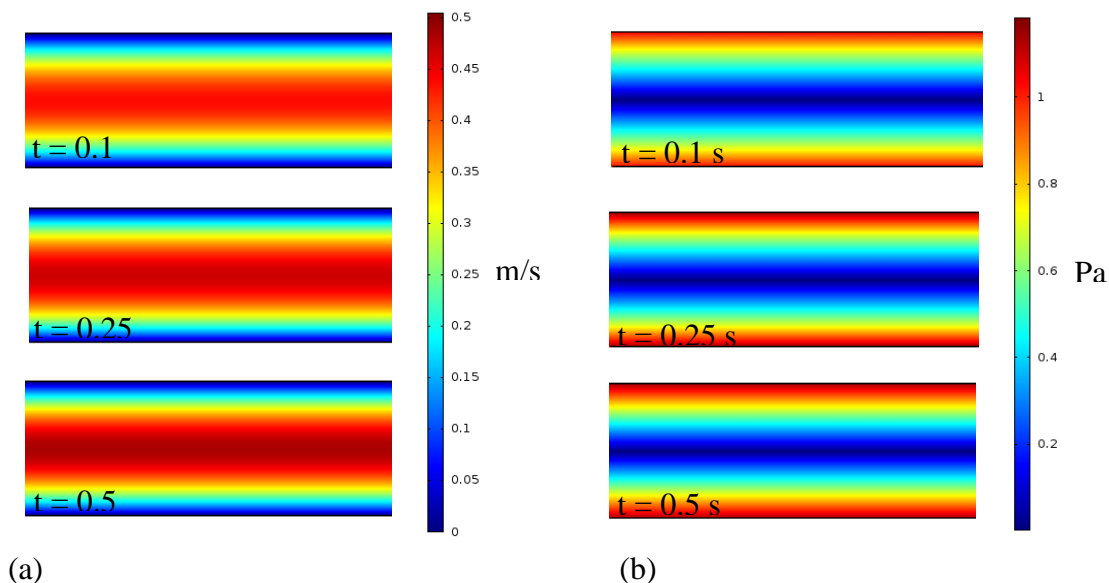

Figures 1 a & b. COMSOL Multiphysics Fluid velocity and shear stress as a function of time for pulsatile flow, see Eqn. (4), between parallel plates. The pressure drop and the gap between the plates are consistent with a medium-sized artery. As illustrated in Figure 1 a & b above, students are able to quantitatively analyze and visualize pulsatile flow between parallel plates at specified times during the cardiac cycle. The slight changes in wall shear stress in Figure 1 (b) can be quantitatively evaluated using COMSOL Multiphysics post processing tools.

### Laboratory Example 3

This analysis is then extended to three-dimensions, pressure-driven flow in a cylinder to represent a blood vessel. In this case, the average velocity and resulting pressure drop can be found readily from the Hagen-Poiseuille equation, viz,

$$Q = \frac{\pi R^4}{8\mu L(P_1 - P_2)}, \quad (5)$$

where  $R$  is the radius of the vessel ( $h$  above for parallel plates) and  $Q$  is the volumetric flow rate. All other parameters are the same as described above. The average velocity is found by simply dividing Eqn. (5) by the cross-sectional area,  $\pi R^2$ ,

$$\langle v_z \rangle = \frac{R^2}{8\mu L(P_1 - P_2)}, \quad (6)$$

and the desired pressure drop is  $(P_1 - P_2) = \frac{8\mu L \langle v_z \rangle}{R^2}$ . For steady-state, pressure-driven flow in a cylinder, the wall shear stress in the r-direction owing to flow in the z-direction,  $\tau_{rz}$ , is given by

$$\tau_{rz} = \frac{P_1 - P_2}{2L} R. \quad (7)$$

All other parameters in Eqn. (7) are described above.



Given below in Table 2 is a comparison between COMSOL Multiphysics and theory.

Table 2. Comparison of COMSOL Multiphysics with theory for steady-state, pressure-driven flow in a cylinder

3D Representation	Average Velocity			Wall Shear Stress $y = h$		
	Theory (cm/s)	COMSOL (cm/s)	% Difference	Theory (Pa)	COMSOL (Pa)	% Difference
Artery	30.0	30.0	0.077	1.440	1.447	0.465
Arteriole	0.780	0.780	0.000	1.440	1.445	0.338
Capillary	0.096	0.096	0.069	1.440	1.451	0.745

Again for the results in Table 2, the COMSOL Multiphysics mesh refinement was set to 'Normal'. Due to limitations in computational facilities, a rigorous mesh refinement was not employed. As shown above, even with a nominally fine mesh, there is excellent agreement between COMSOL and theory for all vessels considered. As with the two-dimensional case, students applied the time-dependent pressure drop as described above in Eq. (4), enabling the students to quantify and visualize the pulsatile effects on the fluid velocity and the wall shear stress, Figure 2 a & b below.

As shown, COMSOL Multiphysics allows symmetry boundary conditions for domains that lend themselves to such simulations, a perfectly symmetric cylinder, for example. In Figure 3 below, the time dependent wall shear stress is shown. Also as is evident in Figures 2 a & b, the students can readily visualize the fluid mechanics throughout the system. One can easily envision incorporating more realistic effects such as stenoses, vessel tapering and distensible walls. Furthermore, one can import actual vessel geometries from CT scans into a program like MIMICs, then import the resulting CAD model into COMSOL Multiphysics (or a program like COMSOL Multiphysics) for a much more realistic model.

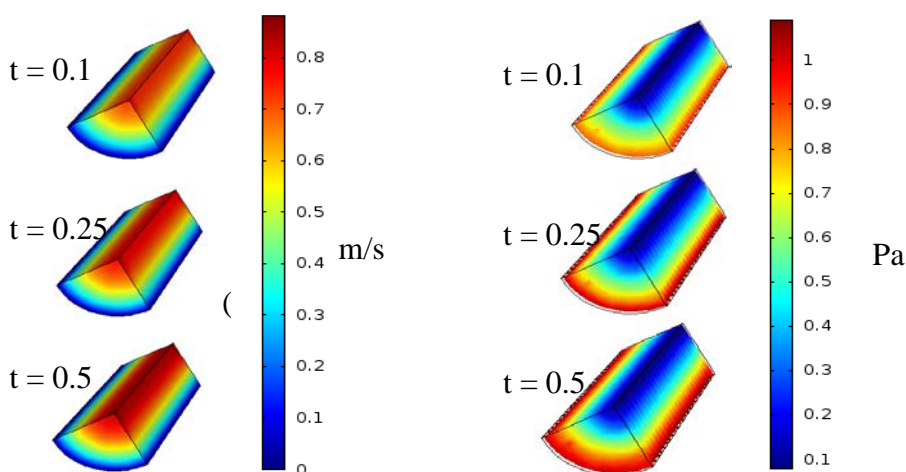

Figures 2 a & b. Time dependent fluid velocity, (a), and shear stress, (b), in a cylindrical representation of an artery. The times were selected in accord with the sinusoidal cardiac cycle described in Eq. 4.

### Diffusion and Convection

Diffusive processes and coupled convective and diffusive processes are at the heart of Biotransport Phenomena. However, diffusive processes are often very slow, difficult to visualize and therefore not feasibly accomplished in a classroom setting. So, how does one help the student study and visualize such processes? In this section, two laboratories are discussed to help illustrate how this can be accomplished using a suitable FEA package such as COMSOL Multiphysics. In the first laboratory students model a drug-eluting stent, and the second laboratory exercise covers tissue oxygenation, more specifically, the Krogh tissue cylinder<sup>3</sup>.

### Laboratory Example 4

In the drug-eluting stent laboratory, students learn how to perform axisymmetric simulations using COMSOL Multiphysics. In this mode, COMSOL Multiphysics employs axisymmetric governing equations, which mathematically account for the three-dimensional nature of a two-dimensional CAD drawing. To perform the laboratory, equi-spaced stent struts are situated along the vessel wall in a two-dimensional geometry. Students then leverage the axisymmetric functionality of COMSOL Multiphysics to produce a three-dimensional solution from the two-dimensional, axisymmetric geometry. The CAD representation and the COMSOL Multiphysics results are shown below in Figure 3.

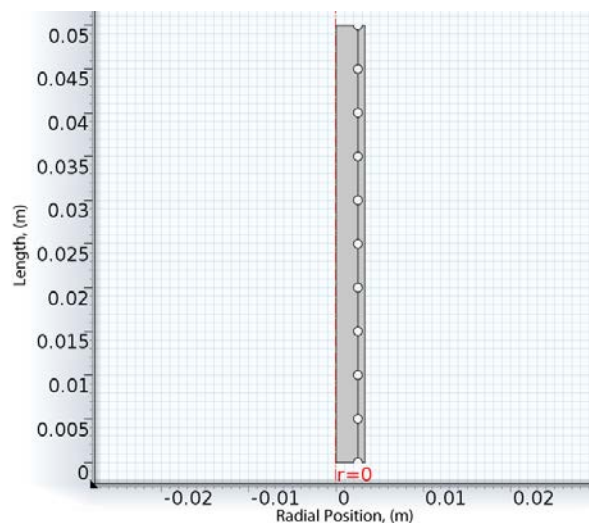
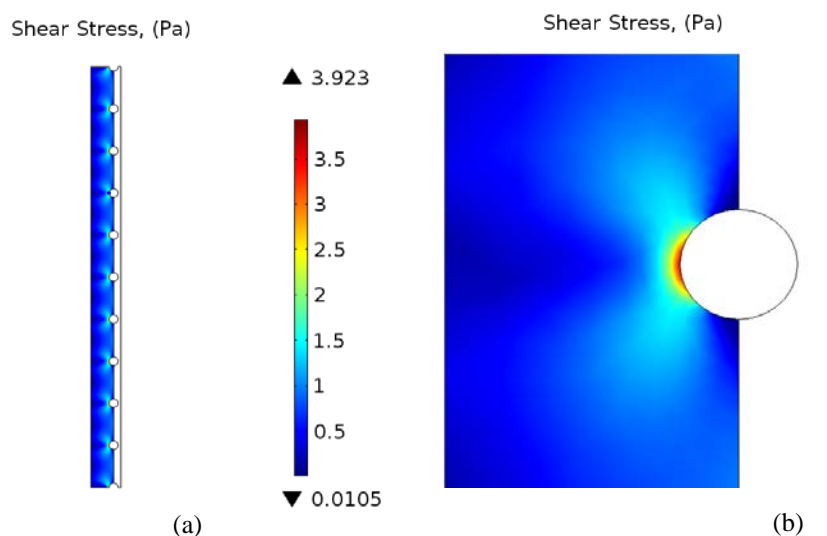

Figure 3. Two dimensional axisymmetric model of an artery with a stent. The circular stent pieces, equi-spaced on the right hand side, are embedded halfway into the tissue denoted by the thinner rectangular region on the far right. The larger rectangle represents the artery. The red dashed line is the axis of symmetry.

As described above in Figures 3, the stent members are arranged in a highly idealized configuration, i.e., circular stent members orthogonal to the flow in the vessel. While this is an idealization, stent members orthogonal to the flow do represent the worst-case scenario for stent erosion, that is, stent members orthogonal to the flow experience the greatest shear stresses. The fluid flow is from top to bottom. Students are able to quantify and visualize the distribution of shear stress between stent strut members with COMSOL Multiphysics as shown in Figures 4 a & b. In Figure 4 (b), the shear stress on the circular stent member illustrates where erosion is likely to be the greatest, i.e., at the fluid-side stent member tip. Also, on the endothelium, the shear

stress approaches zero on the up and down stream edges of the endothelium. These low shear stress regions on the endothelium are on the order of the stent member radius. The endothelium is healthiest when experiencing a basal level of shear stress; therefore, understanding the shear stress distribution is critical for endothelial lining health and therefore a critical aspect of stent design. In addition to enabling exploration of changes in endothelial shear stresses, the orthogonal members do give a reasonably good representation for the analysis of drug elution and drug concentration distributions in tissue and in the blood stream, see Figure 5 below.



Figures 4 a & b. Shear stress on and between stent members. In (a) the shear stress distribution is shown along all stent members, In (b), the shear stress distribution is more easily visualized on a single stent member.

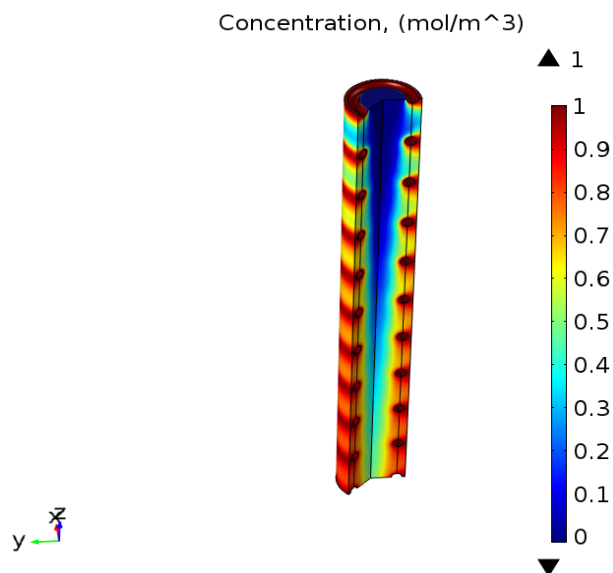

Figure 5. Drug concentration distribution from Axisymmetric COMSOL analysis of a drug- eluting stent. The drug experiences both diffusion and convection due to blood flow.

COMSOL Multiphysics allows visualization of drug diffusion and convection under blood flow conditions. The drug, an anti-inflammatory, elutes and diffuses into the endothelial lining of the

artery to prevent restenosis. A portion of the drug diffuses into the tissue and the remainder is lost in the blood stream. Note the incursion of drug in the downstream region of the vessel. The computational exercise allows students to observe and quantify drug concentrations in both the tissue and in the blood. Once set up and performed, the students gain the ability to incorporate and analyze coupled physical phenomena, i.e., fluid flow and diffusion in COMSOL Multiphysics. With this foundation, students or researchers can leverage a basic model like this to gain insight into shear stress and concentration distributions results associated with more realistic stent designs in a true three-dimensional model. (For the purpose of a teaching laboratory, incorporation of a realistic stent design would be a project in and of itself and beyond the scope of a single laboratory assignment.)

### Laboratory Example 5

Another essential physiological process is tissue oxygenation. Again, by developing an axisymmetric model of a capillary with surrounding tissue, students are able to determine optimal tissue radii around capillaries in muscle to sustain cell viability. This is precisely what Krogh did analytically in 1919<sup>3</sup>. A CAD drawing for an axisymmetric representation of a capillary surrounded by tissue is shown below in Figure 6.

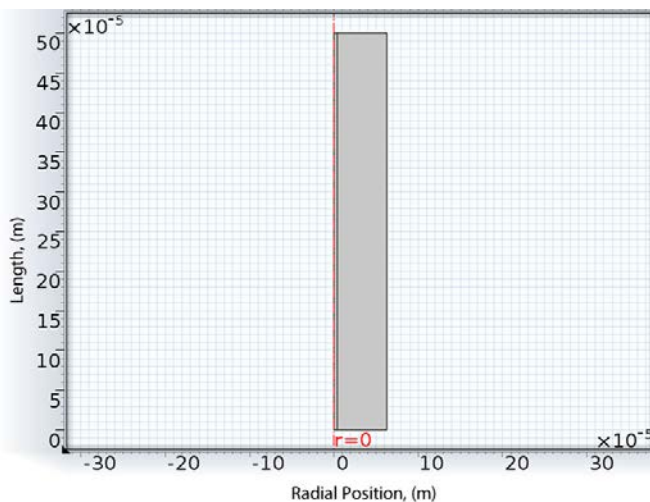
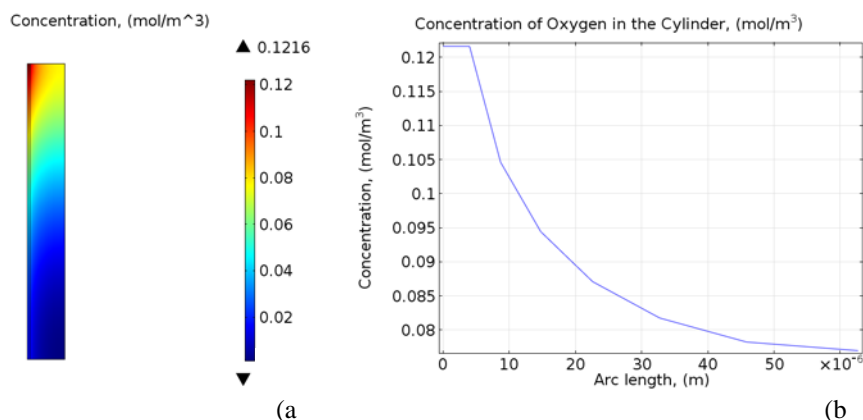

Figure 6. The Krogh tissue cylinder. An axisymmetric CAD representation of tissue surrounding a capillary. The large rectangle represents the tissue and the thinner rectangle adjacent to the axis of symmetry, at  $r = 0$ , represents the blood vessel.

In Figure 6 above is a two-dimensional CAD representation of a Krogh tissue cylinder. The tissue consumes oxygen at a specified metabolic rate. As the oxygenated blood enters and passes through the vessel, oxygen diffuses radially through the capillary wall into the tissue where it is consumed. If the tissue cylinder radius is too large, then the concentration of oxygen in the tissue on the venous side of the capillary (efferent end) is reduced below concentrations needed to sustain cell life, resulting in hypoxia and tissue necrosis; however, during developmental physiology, the capillaries are arranged such that there is an optimal spacing between capillaries to sustain cell life; therefore, there is an optimal Krogh tissue cylinder radius. Students are given an oxygen inlet concentration, a consumption rate of oxygen in the tissue, blood flow rate, and diffusivities of oxygen in both the blood and in the surrounding tissue. Using these data,

students are able to utilize COMSOL to visualize the metabolic consumption throughout the tissue given various tissue radii, as shown in Figures 7 a & b.



Figures 7 a & b. Concentration profiles in a Krogh Tissue cylinder. In (a) shows a surface plot demonstrating the concentration throughout the cylinder. In (b) is the concentration profile from the capillary, far left, radially to the edge of the tissue cylinder, at the top of the cylinder.

The students can then use tools in COMSOL to analyze the concentration in different parts of the Krogh tissue cylinder, furthering their understanding of how oxygen levels behave due to the coupled diffusive and convective effects. In the laboratory exercise, students determine the optimal tissue radius surrounding a capillary. Then they are asked to explore the effects of a sudden 20% increase in blood flow rate. Does the tissue become hypoxic? Through this laboratory, students further investigate Krogh's work. Furthermore, students explore various scenarios, that is, changes in flow rates, to quantify and visualize oxygen concentrations in the blood and tissue.

## Conclusions

COMSOL Multiphysics has proven to be an excellent resource for computational laboratories, complementing and augmenting the teaching of BioTransport Phenomena at Cal Poly San Luis Obispo. As illustrated in this article, COMSOL Multiphysics exhibits excellent agreement with theory for both average fluid velocity and wall shear stress. Through the use of computational methods, students are able to study diffusive processes within the allotted time of the laboratory class. Furthermore, students are able to explore mathematically intensive Bioengineering problems with relative ease through an easy to use, commercially available FEA package. Most importantly, students are able to visualize physiological transport processes via COMSOL Multiphysics with which they previously experienced difficulty or were not able to observe. Finally, COMSOL Multiphysics is becoming an industry relevant FEA capability, and through this course, students gain valuable experience applying this FEA capability to relevant Biomedical Engineering problems.

## Bibliography

1. R. B. Bird, W.E. Stewart, and E. N. Lightfoot, *Transport Phenomena*, 2<sup>nd</sup> ed., John Wiley & Sons, New York, 1962.
2. A. Vander, J. Sherman, and D. Luciano, *Human Physiology, The Mechanisms of Body Function*, 8<sup>th</sup> ed., McGraw-Hill, New York, 2001.
3. R. L. Fournier, *Basic Transport Phenomena in Biomedical Engineering*, 3<sup>rd</sup> ed. CRC Press Taylor & Francis Group, Boca Raton FL, 2012.

## **Student Project: Demonstration of Production of Necessary Gases for Return from and Survival on Mars – Automated Methane, Oxygen, and Hydrogen Production Using a Solar Powered Electrolysis Tank and a Table Top Sabatier Reactor**

David Dillon, Huseyin Sarper, Nebojsa Jaksic, and Jude DePalma  
Colorado State University, Pueblo

### **Abstract**

Current engineering education literature supports a number of approaches and methods to help students learn. In this paper, an exciting, multi-year engineering project supported by NASA is described as a means of retaining students in STEM and increasing their knowledge and skills through problem-based learning, project-based learning, active learning, peer learning, and group learning methods. The necessary scaffolding for freshman and sophomores is provided through frequent consultations with discipline professors and upper classmen. A main impediment to a round trip crewed mission to Mars is the prohibitive cost associated with taking the return fuel along. Return fuel ( $\text{CH}_4$ ) and necessary life support chemicals (oxygen) must be produced using *in situ* resources (water and  $\text{CO}_2$ ). The Colorado Space Grant Consortium group from our university continues to experiment with optimization of methane ( $\text{CH}_4$ ) gas production using a Sabatier reactor. It stipulates the use of available  $\text{CO}_2$  in the Martian atmosphere along with Earth-supplied (initially) hydrogen gas. To model methane production using *in situ* resources, a 32-liter solar powered electrolysis tank using Plexiglas and NaOH as electrolyte for production of hydrogen and oxygen gases using water was built. Two serially connected 6 volt marine batteries were used to store solar energy and provide constant voltage to the tank. A variable peristaltic pump was used to inject hydrogen into the reactor. The unit electrodes were welded to the ends of insulated stainless steel rods within the tubes. Each tube has a valve to extract gas. The unit includes an agitator to mix the solution and maintain optimal current.  $\text{CO}_2$  is supplied from a canister to the reactor. Both reactions were combined into a single, near closed-loop system. While solar panels provide current for electrolysis, line current provides heating of the catalyst chamber. Recently, students automated separation of gases from the Sabatier reactor using a cryogenic chamber, National Instruments myDAQ controller, and appropriate sensors. In the paper, we present the details of the project design, the operation of the system, the gas rate production results, and a study of educational impact on student learning and retention.

### **Introduction**

Curiosity about the heavens is deep-seated in the human psyche. Every civilization has had its mythology about the points of light in the night sky and the role of the sun and moon. Literature abounds with stories of space travel to the moon, planets, and beyond. The many novels of Edgar Rice Burroughs's *Barsoom* series (1912-1965), H. G. Wells' *War of the Worlds* (1898), and Jules Verne's *From the Earth to the Moon* (1865) are among the more recent of the early works on space. As a species, our first real move into space came with the launch of *Sputnik* (1957) ushering in the era of near-Earth space travel, followed by sub-orbital space flights by Yuri Gagarin (*Vostok 1*, 1961) and Alan Shepard (*Freedom 7*, 1961), and the first Earth-orbital flight by John Glenn (*Friendship 7*, 1962). Our first footprints on another planetary body were made by Neil Armstrong and Buzz Aldrin during the mission of *Apollo 11* to Earth's moon (1969) as a

culmination of President Kennedy's 1961 pledge to put a man on the moon before the end of the decade.

With interplanetary travel now almost a reality, the practical matter of not only going but returning had to be considered. The various missions to Earth's moon required the inclusion of a significant, but manageable, mass of fuel along with the moon lander to enable lift-off from the lunar surface, re-engaging with the lunar orbiter, and exit from lunar orbit to return to Earth. For trips to other planets, such as Mars, the cost of including return fuel with the mission payload is prohibitive. Mars offers an intriguing option, however, made possible by a well-known chemical reaction first reported in 1902 by Paul Sabatier in which carbon dioxide (CO<sub>2</sub>) and hydrogen (H<sub>2</sub>) are combined catalytically with formation of methane (CH<sub>4</sub>) and water (H<sub>2</sub>O)<sup>1</sup>. Although the Martian atmosphere with a surface pressure ranging from approximately 4-9 mb is much less dense than Earth's, it is composed of approximately 96% CO<sub>2</sub><sup>2</sup>. The abundance of CO<sub>2</sub> makes possible the synthesis of return fuel on site as has been suggested by Zubrin and others<sup>3,4</sup>. Construction of a Sabatier reactor and methane collection tanks could, in principle, be done by a prior automated mission in order to have a supply of methane available when the first humans make landing. A Sabatier reaction could also be used to reduce CO<sub>2</sub> in a Martian habitat or space vehicle<sup>5-6</sup>. Others<sup>6,7,8,9,10,11</sup> discuss various aspects of this reaction. Methane is a powerful fuel that can be used for lift off from Mars and as fuel for vehicles and rockets that transport settlers within Mars.

To construct a Sabatier reactor and synthesize methane using Martian CO<sub>2</sub> would require an initial supply of H<sub>2</sub>, a catalyst (ruthenium supported on alumina, Al<sub>2</sub>O<sub>3</sub>, is commonly used), an energy source (such as solar cells), a means of separating CH<sub>4</sub> from by-product H<sub>2</sub>O and excess reactant (CO<sub>2</sub> or H<sub>2</sub>), storage capacity for CH<sub>4</sub>, and a recycling system to reclaim H<sub>2</sub> from H<sub>2</sub>O by-product by electrolysis so that it could be returned as input to the Sabatier reactor. The overall Sabatier reaction (Eq. 1) consumes 4 moles of H<sub>2</sub> for each mole of CO<sub>2</sub> and produces CH<sub>4</sub> on an equal molar basis with input CO<sub>2</sub> along with 2 moles of vapor phase H<sub>2</sub>O which, under standard pressure and temperature on Earth, condenses to the liquid phase. The overall process is exothermic<sup>12</sup>. Until a local source of water can be accessed on Mars, hydrogen would have to be supplied from Earth.

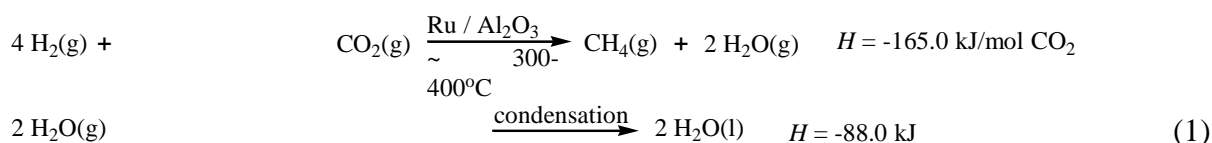

By capturing and subjecting the by-product water to electrolysis, half of the initial H<sub>2</sub> can be recovered for recycling (Eq. 2). Nevertheless, in the long term, a local source of water for hydrogen production would be necessary. The electrolysis of water also produces oxygen, O<sub>2</sub>, necessary for life support and an oxidant for fuel CH<sub>4</sub>. Separation and storage of O<sub>2</sub> was also considered in this project.

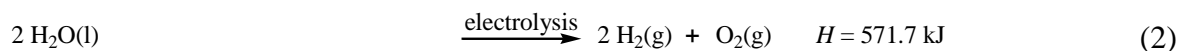

In terms of combustion requirements for return fuel (Eq. 3), the quantity of methane produced by the Sabatier reaction is in excess relative to the amount of oxygen that can be obtained by electrolysis of the by-product water. One approach to dealing with the excess

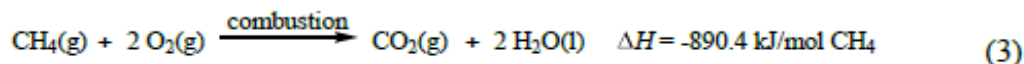

methane is pyrolysis or high-temperature decomposition. The products of pyrolysis of methane are carbon and hydrogen (Eq. 4). The hydrogen can be used to supplement that needed to continue the Sabatier reaction<sup>759</sup>.

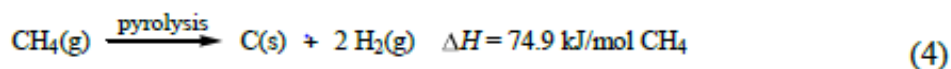

This project involved students and staff in the Engineering and Chemistry Departments in the design, construction, and testing of a near self-contained Sabatier / solar electrolysis system for production of CH<sub>4</sub> in a demonstration unit as shown in Figure 1. The system is “near” self-contained because it still uses wall power in addition to the solar power. The system is comprised of a Sabatier reactor consisting of gas supply, pressure and flow regulators, mixing valve, heated catalyst chamber, and output lines; a water electrolysis unit consisting of 32 liter aquarium, with perforated electrodes, electrolyte (sodium hydroxide, NaOH), separated Plexiglas gas collection chambers, and a peristaltic pump to feed H<sub>2</sub> into the Sabatier reactor; three 15-W solar panels connected to two 6-V Marine batteries in series to provide power to the electrolysis unit; and a cryogenic separator. The system schematic (the system as envisioned to operate on Mars) is shown in Figure 2. During the initial testing phase of the Sabatier reactor, gases (CO<sub>2</sub> and H<sub>2</sub>) were supplied using commercial compressed gas cylinders, but completion of the electrolysis unit permitted H<sub>2</sub> to be supplied by decomposition of water. In concept, the Sabatier reactor would use Martian CO<sub>2</sub> along with H<sub>2</sub> that would initially be transported from Earth either as compressed gas or in combined form as water that would be subjected to electrolysis on the Martian surface for production of necessary H<sub>2</sub>. With the discovery of ice beneath the Martian surface, the possibility of obtaining H<sub>2</sub> from local sources arises.



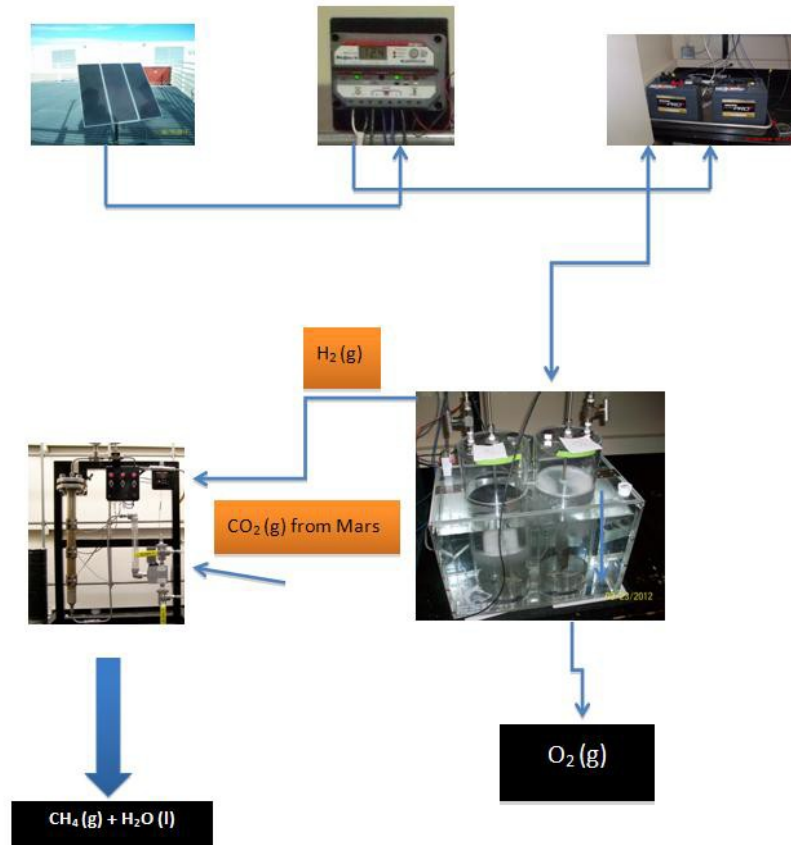

Figure 1. The Sabatier reactor/solar electrolysis system.

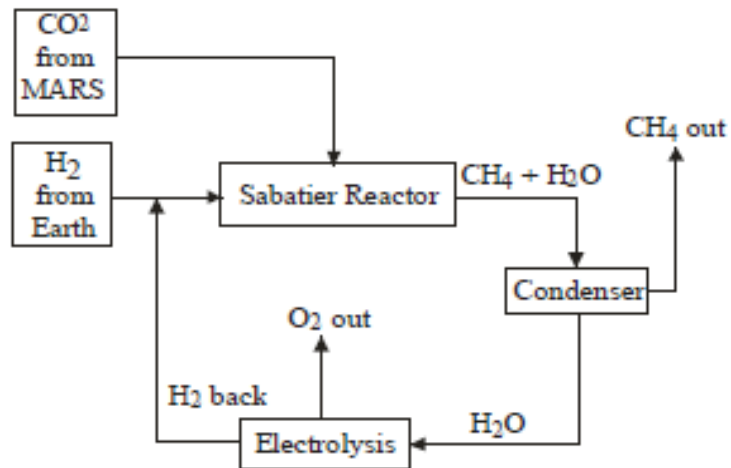

Figure 2. The system schematic.

### Sabatier Reactor

Students and staff designed a table-top apparatus to house the Sabatier reactor including CO<sub>2</sub> and H<sub>2</sub> gas inlets and mixing chamber, a flow meter, a thermostated (Watlow controller) electrically heated catalyst chamber, a pressure control needle valve, and a gas outlet (Fig. 3). The assembled apparatus weight was approximately 20 pounds.



Figure 3. Table-top Sabatier reactor with cryogenic separation dewars.

In our demonstration apparatus, gases (CO<sub>2</sub> and H<sub>2</sub>) entered from compressed gas cylinders by way of the inlet valves (yellow valve handles visible at center and lower center of Fig. 3). From the valves, gases entered a flow meter and were then directed to the catalyst chamber (38 cm x 3 cm vertical stainless steel tubing at left side of apparatus). The catalyst chamber (engineering drawing is in Appendix A) was heated by three heating bands with feedback control to the Watlow controller (upper right corner of apparatus). Heating bands have individual switches and status indicator lights (near center top of apparatus). Output from the reactor was directed sequentially into three Dewar flasks (right side of Fig. 3 and shown in Fig. 4). The first flask contained ice-water at 0°C to condense water vapor formed in the reaction. The next Dewar contained a mixture of dry ice and either acetone or isopropyl alcohol at -78°C where excess or unreacted CO<sub>2</sub> would be deposited. The third Dewar was filled with liquid nitrogen at -196°C to condense CH<sub>4</sub> formed in the reaction and seen in the rightmost Dewar in Fig. 4 and burning at the exit port of the Dewar in Fig. 5. If the Sabatier reactor was operated with an excess of hydrogen, unreacted H<sub>2</sub> could also exit the third Dewar because it cannot be condensed to liquid form using cryogenics readily available for our use.



Figure 4. Separation of  $\text{H}_2\text{O}$ ,  $\text{CO}_2$ , and  $\text{CH}_4$ .

The catalyst chamber (visible at left side of apparatus in Fig. 3) included an approximately 5 cm depth of 4A molecular sieves at the bottom of the chamber for mixing of gases. Above the sieves, approximately 300 g of ruthenium catalyst (5% Ru on alumina ( $\text{Al}_2\text{O}_3$ ) pellets) was added to fill the catalyst chamber. Although the Sabatier reaction is exothermic, high temperatures are required to initiate it. To aid in maintaining the reaction temperature and preventing heat loss during routine operation, fiberglass insulation was added to the catalyst chamber (Fig. 6). Insulation was secured at top (as seen in Fig. 6), middle, and bottom by wrapping with metal wire. It was noted that, in comparison to operation during initial testing without insulation in place, the heating circuits cycled on less frequently after insulation was added. This should greatly increase the energy efficiency of the reactor.



Figure 5.  $\text{CH}_4$  flame at output.



### Figure 6. Insulating the Sabatier catalyst chamber

To evaluate the efficiency and operation of the Sabatier reactor, output gases were sampled by gas-tight syringe at a port prior to the cryogenics and were analyzed by gas chromatography-mass spectrometry (GC-MS) using a Hewlett-Packard 5890 GC with 5971 MSD (mass-selective detector) in scan mode covering a mass range from  $m/z$  2-50 ( $m/z$  is mass-to-charge ratio). Prominent peaks in the mass spectrum (Fig. 7) are at  $m/z$  16 ( $\text{CH}_4$  molecular ion), and a series of peaks with  $m/z$  15-12 (fragmentation peaks formed from  $\text{CH}_4$  by consecutive loss of hydrogen atoms). Additional important peaks are seen at  $m/z$  18 ( $\text{H}_2\text{O}$  molecular ion), 44 ( $\text{CO}_2$  molecular ion), and 2 ( $\text{H}_2$  molecular ion). Peaks at  $m/z$  28 and 32 are due to atmospheric nitrogen ( $\text{N}_2$ ) and oxygen ( $\text{O}_2$ ), respectively. In addition, the mass spectral signature of  $\text{CH}_4$  from the Sabatier reactor was confirmed by comparison with the mass spectrum of an authentic sample of reagent grade  $\text{CH}_4$ . Once operation of the Sabatier reactor had been verified by mass spectral analysis and detection of methane, further testing to optimize gas flow rates, pressures, and catalyst chamber temperatures was monitored by measuring output of liquid water. The volume of liquid water was converted to moles of water and, using the Sabatier reaction equation (Eq. 1), molar quantity of co-produced methane was calculated. Significant methane production, calculated from collected water, was observed at ratios of 3-4:1 ( $\text{H}_2:\text{CO}_2$ ), flow rates of 100-200 mL/min, and temperatures of approximately 350°C.

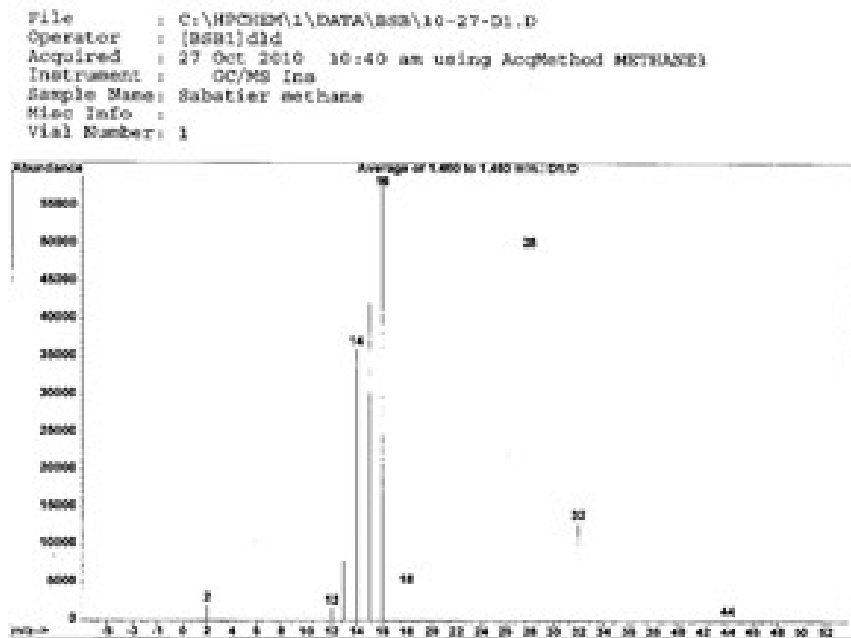

Figure 7. Mass spectrum of Sabatier output gases.

## Solar Electrolysis

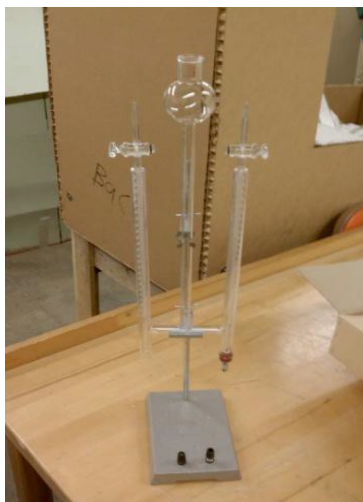

Figure 8. Commercial Hoffman electrolysis demonstration apparatus

Initially, students used a commercial Hoffman electrolysis system (Fig. 8) to test various electrode materials and electrolytes for efficient electrolysis of water. Carbon, copper, and stainless steel were evaluated as electrode materials; stainless steel was selected for the final apparatus. Sodium chloride (NaCl) and sodium hydroxide (NaOH) were evaluated for use as electrolyte. Use of NaCl as electrolyte produced corrosive chlorine or oxides of chlorine during over-voltage operation resulting in corrosion of the electrodes. Appendices B and C show hydrogen gas production using this Hoffman device.

Although NaOH is corrosive to some materials, its use as the electrolyte was found superior due to lack of formation of materials corrosive to the stainless steel electrodes. Various concentrations of NaOH were tested and found to give increased rate of gas production as concentration was increased from 0.010 mol/L to 2 mol/L. Although not the concentration of maximum gas production, NaOH at 0.50 mol/L was selected as the electrolyte primarily based on safety considerations.

After selecting electrode materials and electrolyte, the demonstration apparatus was constructed using a 32-liter aquarium (51 cm x 24.7 cm x 29 cm inside dimensions) with separated anode and cathode chambers (Fig. 9). Electrodes were made from perforated stainless steel plates folded into a zigzag arrangement for increased surface area and welded onto the ends of 38 cm insulated stainless steel support rods. Appendix D shows the components of the system shown in Figure 9.

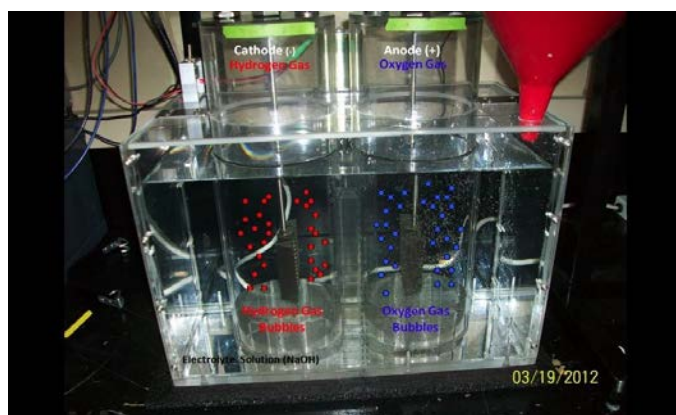

Figure 9. Aquarium-based Hoffman electrolysis apparatus (gas bubbles have been color-coded to indicate where  $\text{H}_2$  [red] and  $\text{O}_2$  [blue] are formed).

In testing the electrolysis apparatus interface with the Sabatier reactor, the co-produced  $\text{O}_2$  was exhausted to room air while the  $\text{H}_2$  was directed into the Sabatier reactor by means of a

peristaltic pump (not shown in Fig. 9). The pump can be seen in Appendix E. Two marine batteries that store solar energy are also visible in Appendix E. The pump rate was adjusted to maintain constant volume of electrolyte solution in the electrode compartment. Power for the electrolysis was supplied by two marine batteries attached to a series of solar panels for recharging. Appendices E and F show production rates of hydrogen and methane under various conditions. Appendix G shows methane production by using the hydrogen produced by solar electrolysis.

### Cryogenic Separation

As shown in Fig. 3,  $\text{H}_2\text{O}$ ,  $\text{CO}_2$ , and  $\text{CH}_4$  can be cryogenically separated using appropriate cooling chambers. Because  $\text{H}_2$  has a boiling point lower than that of liquid nitrogen, it cannot be liquefied using cryogens that are readily available. However, liquid water and  $\text{CO}_2$  may be separated with appropriate coolants. Students designed an automated cryogenic separation chamber to recover by-product water for electrolysis to recycle  $\text{H}_2$  back to the Sabatier reactor (Fig. 10). The water cryogenic separator was designed to operate at a thermostated temperature of  $0\text{-}2^\circ\text{C}$  maintained by recirculated ice-cold fluid through the copper coil.

Since  $\text{CO}_2$ ,  $\text{H}_2\text{O}$ , and  $\text{CH}_4$  liquefy at different temperature pressure domains, it should be relatively easy to separate them using cryogenic separation. However, this separation process operates at low temperatures, near to  $-80^\circ\text{C}$ , and/or possibly with high pressures of almost 40 bars. A cryogenic chamber is built using aluminum due to aluminum's high thermal conductivity and ease of manufacture.

The first step in the separation procedure was to collect the water vapor since the water liquefies in the system at temperatures in the range of  $0 - 3^\circ\text{C}$ . Figure 10 shows the bottom cap which is 3 inches in diameter, the cylinder tube which is approximately 12 inches in length and the top which is 4.9 inches in diameter. These three parts were welded in order to form the cryogenic  $\text{H}_2\text{O}$  separator.

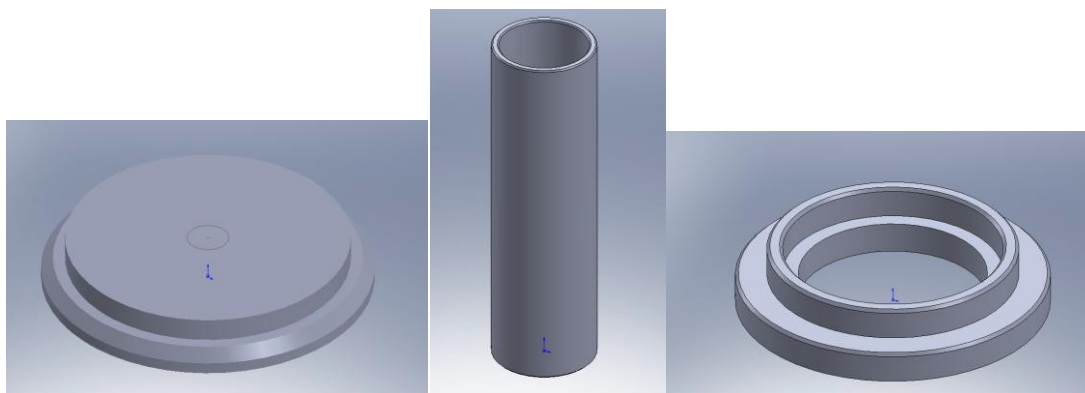

Figure 10. Designs for bottom (left), cylinder, and cap (right) of cryogenic  $\text{H}_2\text{O}$  separator.

To automate this system a float sensor is connected to a valve attached to the bottom of the separator. Since there was a need to create a flat surface to add the float sensor the student team designed a connector represented in Figure 11 that was welded to the separator.

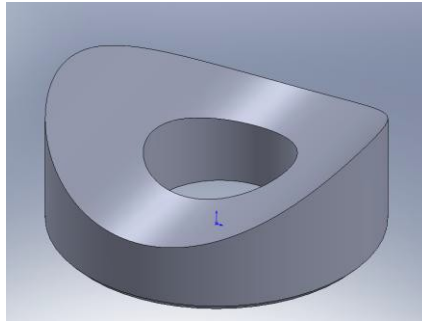

Figure 11. Connector welded to water cryogenic separator.

Since further modifications were anticipated in case that the sensor does not perform as expected, only the top cap shown in Figure 12 would need to be re-assembled. Thus, the top part (4.9 inches in diameter) is not welded to the main assembly.

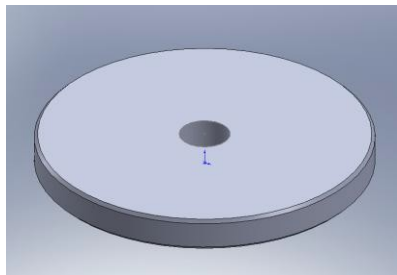

Figure 12. Top part used for both cryogenic separators.

The student team acquired a chiller to collect the liquefied water vapor. Water from the chiller circulates around the water cryogenic separator via copper tubing (high thermal conductivity) that is wound around the water cryogenic chamber. A thermostat was placed inside of the chamber to monitor the temperature inside the chamber and to verify that it is in the range of 0 – 2°C. Styrofoam insulation was applied around the chamber in order to avoid heat transfer with the atmosphere. Figure 13 shows the copper tubing being wound around the water cryogenic separation chamber.

A separate cryogenic chamber was constructed to remove unreacted CO<sub>2</sub> from the output gas stream (Fig. 14a). The metal chamber was housed in a PVC cylinder. In operation, the PVC cylinder was filled with dry ice / methanol mixture (-78°C). To minimize heat exchange with the surroundings, the PVC cylinder was enclosed within a Styrofoam-filled, reflective tape lined box (Fig. 14b).



Figure 13. Water cryogenic separator with copper cooling coils.



Figure 14. CO<sub>2</sub> Cryogenic Separator on PVC Base (left); styrofoam insulated housing (right).

An acrylic storage tank was designed to store methane after separation of water and CO<sub>2</sub> (Fig. 15). In this demonstration unit, methane was stored in gas phase, but designs are in place to liquefy (and solidify) the CH<sub>4</sub> by use of liquid nitrogen (-196°C).



Figure 15. Acrylic methane storage tank.

### **Educational Impact**

In this, four-year NASA Space Grant supported multidisciplinary project there were thirteen students (4 chemistry majors and 9 engineering majors, including two graduate students) engaged. The project encompassed a number of independent study sub-projects and one senior



design project designed to provide a unique space project experience for students and to instill an appreciation of the enormity of effort involved in colonization of Mars. The students were compensated for their efforts. Also, the students presented their findings at two national and two regional conferences. After one of their presentations the professor in charge received an e-mail from a NASA scientist in 2011 praising students' work. The e-mail stated the following:

“As I told you and your students I was greatly impressed by your table top Sabatier reactor system presentation at the Mars Society Convention. I mentioned your work this morning on a telecom with colleagues at JSC about our Mars ISRU demonstration project and they wanted to know your methane production rate. I couldn't remember so I'd appreciate that info along with a copy of your presentation and any publications on the topic that you have.”

There were four faculty members and one lab coordinator who provided help to the students. In addition, Pioneer Astronautics of Lakewood, Colorado, a privately-held company, advised the students on the project's technical matters without compensation. This created a unique learning environment for the students. Students worked on a real engineering/ scientific problem with high aspirations – enable a human mission to Mars. They worked in teams with members from different backgrounds and different experience-levels. Although there was a degree of overlap, teams worked on specific subprojects, including construction of the Sabatier reactor, optimization of Sabatier reaction conditions, chemical analysis of Sabatier output gases, design and construction of the electrolysis apparatus, chemical optimization for H<sub>2</sub> production, and cryogenic separation of gaseous components (capture of H<sub>2</sub>O and CH<sub>4</sub> and removal of excess CO<sub>2</sub>). Team-building activities included discussion sessions focusing on design aspects, output analysis, and improvement strategies. They learned from each other, from their professors, staff, and outside advisors. As a result, all but one undergraduate student finished their degrees (one is still in progress), while one graduate student is currently pursuing a PhD degree.

Being a multi-year project, some students were involved in initial design, construction, and early testing phases, while others came into the project at later stages. Good documentation of activities was practiced by all involved, so that new students could quickly gain understanding of project goals and work completed to date and could therefore join one or more of the various subprojects and contributing members. The project was discussed informally by faculty with prospective new students, and current students, by talking with prospects, were instrumental in recruiting new members.

As an interdisciplinary project, it was expected, and found to be true, that students might be more proficient in certain aspects of the project and subprojects than in others. In one case, breakage of a cryogen container occurred when a student did not realize the importance of the proper mixture of liquid nitrogen with isopropyl alcohol in the CO<sub>2</sub> trap. Too much liquid nitrogen was added resulting in solidification of the isopropyl alcohol. The resulting expansion fractured the Dewar flask that was being used. No injuries and only minimal damage (i.e. loss of the Dewar) occurred as a result. There were occasional arguments arising between team members regarding leadership at the interface between subprojects. As a result, students came to recognize on their own the importance of teamwork and cooperation in a project involving differing levels of expertise between the involved disciplines. One chemical spill occurred when the electrolysis apparatus was left unattended during the early testing phase. As a result

of an incorrect flow rate of the peristaltic pump, electrolyte overflowed onto the surrounding bench and onto the floor. Proper spill clean-up procedure was supervised by the chemistry faculty member. No injuries or damage occurred as a result of this spill.

An objective of this project was to demonstrate that production of methane and of the hydrogen necessary for methane production could be accomplished with solar power. Figure 16 is a photograph of the solar panels used to (mostly) power the hydrolysis system. Figures 17 – 20 show some student team members and their advisors at various events. Fig. 20 shows Mr. Bender (undergraduate student and presenter), Dr. Zubrin (President, Mars Society), Mr. Rael (graduate student and presenter), and Dr. Dillon of Chemistry in left to right order. Dr. Sarper of Engineering is in front. The team took reactor to showcase at the Mars Society Convention.



Figure 16. solar panels used to power hydrolysis system



Figure 17. Some team members during early phase of Sabatier construction.



Figure 18. Mars Society convention, Grapevine, TX, 2011.



Fig. 19. Colorado Space Grant Consortium (2011).



Figure 20. Mars Society convention, Grapevine, TX, 2011.

## Summary and Conclusions

This paper has described design and construction of a system that will be regularly used to sustain human activities on planet Mars once settlement and colonization begin later in this century. Three critical gases (methane, hydrogen, and oxygen) are needed for survival and return travel. These gases do not exist on Mars, but they can (and must) be produced using available (in-situ) resources on the planet. This multi-year project had three phases: (1) operation of the reactor with externally supplied hydrogen, (2) operation of the reactor when hydrogen was supplied from solar electrolysis, and (3) cryogenic separation of the gases. Several students worked diligently on each phase. Students received invaluable experience in engineering and chemistry. All work was carried in our facilities (machine shop, chemistry labs) at the Colorado State University-Pueblo. It is our understanding there are few functioning Sabatier reactors in the world including ours and the one on the International Space Station to remove carbon dioxide. We are very proud to have undertaken such a major project and carried it out successfully. This project received high praise in two Mars Society conventions<sup>13,14</sup> when students presented the results before large audiences that included NASA and ESA engineers and scientists. Dr. Buzz Aldrin of Apollo 11 also attended the 2012 event in Pasadena, CA.

## Acknowledgments

The authors gratefully acknowledge Dr. Robert Zubrin and Mark Berggren of Pioneer Astronautics, Lakewood, CO, for their generous guidance and conversations during this project. Paul Wallace, Shop Manager, Engineering Department of CSU-Pueblo, provided critical assistance in the construction of the Sabatier reactor and the Hoffman electrolysis apparatus. Engineering graduate student Jim Stevenson was instrumental in the early phase of construction of the Sabatier reactor. Engineering student Ivan Aragona-Pagona produced the concept design for the cryogenic separator and was very involved in development and testing of the Hoffman apparatus. Chemistry and engineering student Mike Bender assisted with the early testing phase of the Sabatier apparatus. We gratefully acknowledge funding from the Colorado Space Grant Consortium, Chris Koehler, Director, and Bernadette Garcia, Associate Director. Funds (\$20,000) were used for student stipends, materials used in construction, and travel to venues where the project was presented and/or demonstrated.

## References

1. Sabatier, Paul; Senderens, J.-B. "Direct Hydrogenation of Carbon Dioxide in the Presence of Diverse Metal Catalysts," *Comptes Rendus*, Vol. 134, 1902, pp. 689-691.
2. Cruden, Brett A.; Prabhu, Dinesh; Martinez, Ramon. "Absolute Radiation Measurement in Venus and Mars Entry Conditions." *Journal of Spacecraft and Rockets*, Vol. 49, No. 6, 2012, pp. 1069-1079.
3. Zubrin, Robert; Price, Steve; Mason, Larry; Clark, Larry, "Report on the Construction and Operation of a Mars *In-Situ* Propellant Production Unit," *30<sup>th</sup> AIAA/ASME/SAE/ASEE Joint Propulsion Conference*, AIAA 94-2844, Indianapolis, IN, June 27-29, 1994.
4. Zubrin, Robert; Frankie, Brian; Kito, Tomoko, "Mars *In-Situ* Resource Utilization Based on the Reverse Water Gas Shift: Experiments and Mission Applications," *33<sup>rd</sup> Joint Propulsion Conference and Exhibit*, AIAA 97-2767, Seattle, WA, July 6-9, 1997.
5. Strumpf, Hal J.; Chin, C. Y.; Lester, George R.; Homeyer, Steven T., "Sabatier Carbon Dioxide Reduction System for Long-Duration Manned Space Application," *21<sup>st</sup> International Conference on Environmental Systems*, SAE Technical Paper Series 911541, San Francisco, CA, July 15-18, 1991.
6. Forsythe, Robert K.; Verostko, Charles E.; Cusick, Robert J.; Blakely, Robert L., "A Study of Sabatier Reactor Operation in Zero'G'," *Fourteenth Intersociety Conference on Environmental Systems*, SAE Technical Paper Series 840936, San Diego, CA, July 16-19, 1984.

7. Sharma, P. K.; Rapp, D.; Rahotgi, N. K., "Methane Pyrolysis and Disposing of Resulting Carbon," *In Situ Resource Utilization (ISRU 3) Technical Interchange Meeting*, ISRU, Denver, CO, February 11-12, 1999.
8. Hoekman, S. Kent; Broch, Amber; Robbins, Curtis; Purcell, Richard, "CO<sub>2</sub> Recycling by Reaction with Renewably-Generated Hydrogen," *International Journal of Greenhouse Gas Control*, Vol. 4, 2010, pp. 44-50.
9. Brooks, Kriston P.; Hu, Jianli; Zhu, Huayang; Kee, Robert J., "Methanation of Carbon Dioxide by Hydrogen Reduction Using the Sabatier Process in Microchannel Reactors," *Chemical Engineering Science*, Vol. 62, 2007, pp. 1161-1170.
10. Ash, R. L.; Dowler, W. L.; Varsi, G., "Feasibility of Rocket Propellant Production on Mars," *Acta Astronautica*, Vol. 5, 1978, pp. 705-724.
11. Ash, R. L.; Dowler, W. L.; Varsi, G., "A Fixed Mars ISRU Base for Accelerated Exploration," Presented at the AIAA SPACE 2009 Conference, Pasadena, CA, September 2009, AIAA Paper No. 2009-6555.
12. All enthalpies of combustion were calculated using enthalpy of formation data from <http://thermo.sdsu.edu/testcenter/testhome/Test/solve/basics/tables/tablesComb/formation.html>, accessed January 30, 2014.
13. "Demonstration of Methane, Oxygen, and Hydrogen Production Using a Solar Powered Electrolysis Tank and a Sabatier Reactor", 15<sup>th</sup> Annual Mars Society Convention, Pasadena, CA, 2012 (Sarper, Dillon, Wallace, Aragona, Bender, Rael, Paudel, and Klein).
14. "Table Top Demonstration Reactor for Return Fuel Production", 14<sup>th</sup> Annual Mars Society Convention, Dallas, TX, 2011 (Dillon, Sarper, Rael, Bender, Wallace, and Sauer).

### Appendix A. Design of Sabatier Catalyst Chamber

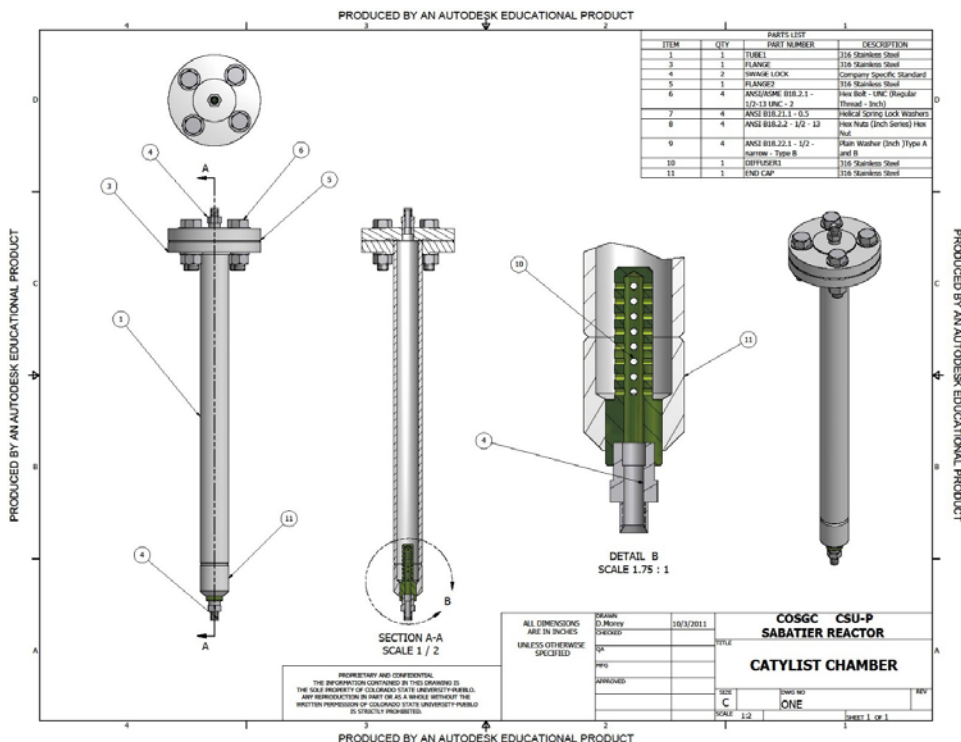

### Appendix B. Gas Production Using Hoffman Electrolysis Apparatus with NaOH (1.01 mol/L)

Voltage	Amperage	Molarity	Time (s)	H <sub>2</sub> (mL)	O <sub>2</sub> (mL)	H <sub>2</sub> Rate (mL/min)
6	6	1.01	0	0	0	
6	6	1.01	470	4	1.3	
6	6	1.01	745	6	2	
6	6	1.01	1136	10	3.6	
6	6	1.01	1332	12	4.4	
6	6	1.01	1800	16.4	6.3	0.6
12	6	1.01	2100	21	8.2	
12	6	1.01	2400	26	10.4	
12	6	1.01	2700	31	12.6	1.0
12	2	1.01	3000	34.7	14.3	
12	2	1.01	3300	38.4	15.9	
12	2	1.01	3600	42	17.5	0.7

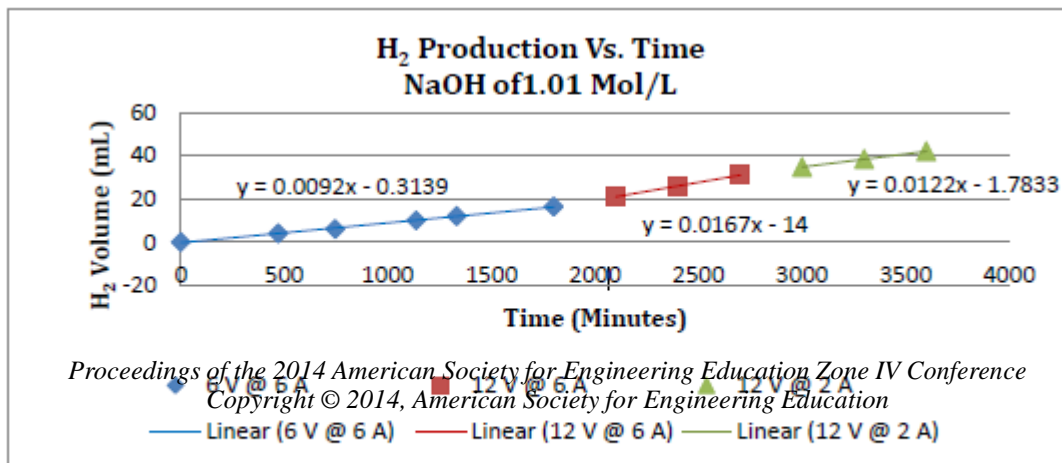

### Appendix C. Gas Production Using Hoffman Electrolysis Apparatus with NaOH (2.0 mol/L)

Voltage	Amperage	Molarity	Time (s)	H <sub>2</sub> (mL)	O <sub>2</sub> (mL)	H <sub>2</sub> rate (mL/min)
6	6	2	0	0	0	
6	6	2	300	5.2	2	
6	6	2	600	10	4	
6	6	2	900	15	6.3	
6	6	2	1200	19.6	8.5	1.0
12	6	2	300	8.7	3.7	
12	6	2	600	17.2	7.7	
12	6	2	900	26	10.7	
12	6	2	1200	34.2		1.7
12	2	2	300	6.4	2.8	
12	2	2	600	12.8	5.9	
12	2	2	900	19.2	8.9	
12	2	2	1200	25.6	11.8	1.3

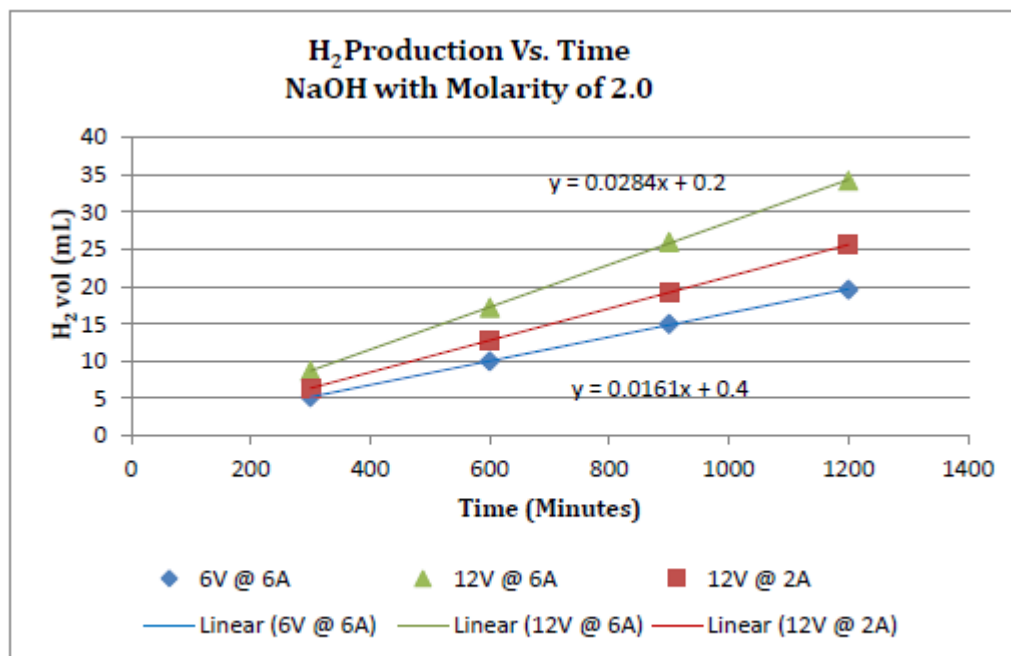

### Appendix D-1. Assembly of Aquarium-Based Electrolysis Apparatus





## Appendix D-2. Aquarium-Based Electrolysis Apparatus Feeding into Sabatier Reaction



## Appendix E-1. O<sub>2</sub> Production as Function of Current, Time, and Agitation at Ambient Atmospheric Pressure (Approximately 640 torr) Using Original Aquarium-Based Electrolysis Apparatus

Current (A)	Time (min)	Height (cm)	Moles of O <sub>2</sub>	Expected Volume (L)	Measured Volume (L)	Comments With or Without Agitator	Error (%)
2.000	30	1.5	0.00933	0.2716	0.2309	With (12V)	15%
2.058	60	2.9	0.0192	0.5590	0.4464	With (12V)	20%
2.058	60	3.3	0.0192	0.5590	0.080	Without	9%
2.058	60	2.7	0.0192	0.5590	0.4156	With (6V)	26%

### Appendix E-2. H<sub>2</sub> Production as Function of Current, Time, and Agitation at Ambient Atmospheric Pressure (Approximately 640 torr) Using Original Aquarium-Based Electrolysis Apparatus

Current (A)	Time (min)	Height (cm)	Moles of H <sub>2</sub>	of Expected Volume (L)	Measured Volume (L)	Comments With or Without Agitator	Error (%)
2.000	30	1.5	5.8	0.0187	0.5432	With (12V)	64%
2.058	60	2.9	8.6	0.0384	1.1180	With (12V)	18%
2.058	60	3.3	7.5	0.0384	1.1180	Without	3%
2.058	60	2.7	7.7	0.0384	1.1180	With (6V)	6%

### Appendix F. H<sub>2</sub> Production as Function of Current, Time, and Agitation at Ambient Atmospheric Pressure (Approximately 640 torr) Using Improved Aquarium-Based Electrolysis Apparatus

Current (A)	Time (min)	Height (cm)	Moles of H <sub>2</sub>	of Expected Volume (L)	Measured Volume (L)	Comments With or Without Agitator	Error (%)
1.955	72	8.9	0.0438	1.2744	1.3300	With (12V)	5%
1.955	80	9.7	0.0486	1.4160	1.4624	With (12V)	3%
2.022	60	7.8	0.0377	1.0984	1.1545	Without	5%
2.106	61	7.8	0.0399	1.1631	1.1699	With (6V)	1%

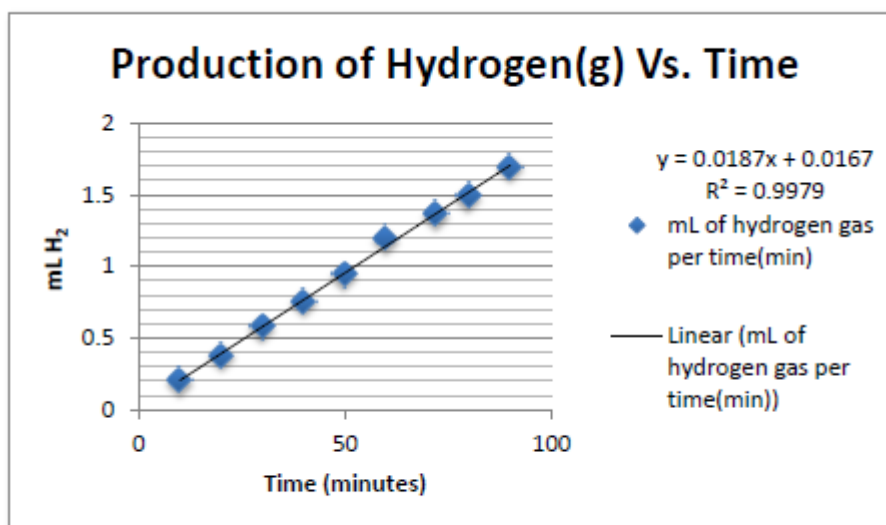

### Appendix G. CH<sub>4</sub> Production Using H<sub>2</sub> From Electrolysis Apparatus as Input to Sabatier Reactor

Trial #	Duration (Hrs)	Collected H <sub>2</sub> O (mL)	Measured H <sub>2</sub> O Rate (mL/min)	Calculated CH <sub>4</sub> Rate (mL/min)	Start Time	End Time
1	1	0.5	0.0083	0.0042	6:10 PM	7:00 PM
2	3	2.5	0.0139	0.0069	7:10 PM	10:10 PM
3	10.3	6.5	0.0105	0.0052	10:11 PM	8:30 AM
4	2	1.8	0.015	0.0075	1:30 PM	3:30 PM
5	4	3.4	0.0142	0.0071	11:07 AM	3:07 PM

Total hrs	Total H <sub>2</sub> O collected	H <sub>2</sub> O rate (average)	CH <sub>4</sub> rate (average)
20.3	14.7	0.01238	0.00619

## **HSI STEM: Research Opportunities to Improve Retention and Increase the Pipeline to Graduate School**

Gino Galvez, Eric Marinez, and Alvaro Monge  
California State University, Long Beach

### **Abstract**

This paper describes the summer and winter research experience programs that are part of the Hispanic Serving Institution (HSI) STEM grant awarded to the California State University Long Beach (CSULB). While the grant has several components, this paper's focus is on The Summer Bridge to the Beach and the Winter Research Experience programs. Both of these programs match Latino students seeking a STEM degree with faculty mentors in their chosen majors. The summer program fills a critical need that exists in transitioning Latino students from community colleges to a 4-year university to complete their baccalaureate STEM degree. Among the program's goals are to facilitate the transfer students' transition to the CSULB campus, to engage them in projects in their major, and to provide mentorship from faculty. The Winter Research Experience provides Latino students an opportunity to engage in research with faculty in their major. This program is meant for academically strong students who have little to no experience in research. The goals of this program are to ignite students' interest in research which can then increase motivation to persist and complete their STEM degree. This paper presents preliminary results from two years of implementing both programs. The results show that students have a higher appreciation and understanding of research and will seek other research opportunities in the future as a result of their participation.

### **Introduction**

In 2011, California State University Long Beach (CSULB) successfully received a Hispanic Serving Institution STEM grant from the US Department of Education. The grant serves Latino students from the College of Natural Sciences and Mathematics and the College of Engineering and its focus is to increase retention and graduation of underrepresented Latinos in the STEM fields. To meet the goals, a multi-pronged approach is used to increase academic performance and retention of Latino students. While the grant has several components, this paper will present the two programs that engage Latino students in research: the Winter Research Experience and the Summer Bridge to the Beach.

### **Background**

The two programs described in this paper place students in an active research project with a faculty mentor and ideally other peers. Such strategy is one that has been shown to be effective in improving students' sense of belonging and in increasing the relevance of the knowledge acquired in STEM courses. Hurtado et al.<sup>1</sup> report on the significant impact that the relevance of such knowledge has on a student's life on campus. Both programs provide such relevance by immersing the students in a research environment where they are taught about research techniques and where they are expected to apply their own knowledge. That same study also reports on reasons why underrepresented racial minority (URM) students leave the sciences. Among the factors is "the lack of social value or relevance to improving conditions for their

communities”, something also reported by Bonous-Hammarth<sup>2</sup>. The research experiences can make those connections that will motivate URM students to persist in their STEM major.

Another of the goals of the research experience programs is to increase the number of Latino students who seek and complete a graduate degree in STEM. It is research experiences like these programs that have been shown to be effective at increasing students’ chances of completing a STEM degree and to pursue a graduate degree<sup>3,4</sup>. It is clear from the literature<sup>1</sup> that finances play an important part in the degree to which URM students participate and succeed in college. The financial stipend or scholarship offered to participating students in both programs can help to reduce the financial stresses that Latino students have, thus freeing them to focus on their academic endeavors.

### **The Summer Bridge to the Beach**

It is imperative for HSI STEM at CSULB to address the Latino Educational Pipeline and it does so through its “Summer Bridge to the Beach Program.” The literature reveals that the majority of Latino students attend a community college versus a 4-year university following high school graduation. Additionally, 33% of all California Community College students in 2006 were Latino students and this population represents a growing proportion of California Community College students. In California, 75% of all first time Latino college students attend a community college with 40% of them aspiring to transfer to a four-year institution. Of the 75 percent that attend community college only 7 will transfer to a four-year university. Interestingly, six out of the seven who transfer will attend a CSU.<sup>5</sup>

In order for Latino students to graduate from four-year institutions, it is critical that universities increase the number of Latino students who transfer to and persist in these institutions. Although many community college students desire to transfer to a four-year institution, the dismal transfer rate has been associated with transfer institutional neglect. Transfer institutional neglect fails both at the community college and the four-year institution, where most universities do not provide an adequate number of resources for transfer students to be successful. One way to mitigate institutional neglect is to connect the student prior to attending the university with a faculty member in their department, enrich them with the services offered at the institution, and provide them with the social network to assure them they are valued members of the institution. Rivas et al. suggest a list of recommendations to increase the number of Latino students who transfer to a four-year institution and ultimately pursue a graduate degree<sup>6</sup>. Several of these recommendations have been built into the Summer Bridge to the Beach Program and include an effort to develop an institutional transfer culture by offering a transfer-specific summer research program.

The HSI STEM “The Summer Bridge to the Beach Program” provides transfer Latino STEM students with an understanding and appreciation for research, while facilitating their transition to the CSULB campus. This is accomplished by engaging them in active projects in their major, providing mentorship from faculty, and enhancing their professional development by offering specific workshops targeted toward their research experience and to facilitate their transition into an existing minority program or internship. Specific objectives of the program are to increase:

1. Each student's ability to apply content and skills learned in the classroom to research
2. Their understanding of the research process
3. The notion that science is a creative process that advances further knowledge
4. Their knowledge of ethical conduct in their field
5. Their ability to interpret results in research and draw conclusions

The Summer Bridge to the Beach is a program that closely resembles the National Institutes of Health "Bridges to the Baccalaureate" program, which CSULB has had since the 1990s<sup>7</sup>. The NIH program targets community college students who are currently students from two partner institutions, Cerritos College and Long Beach City College, and who are majoring in either chemistry, biochemistry, or biological sciences. A major mission of the program is to prepare the students to transfer and earn a bachelor's degree from a 4-year institution and ultimately increase the number of minority students who earn a doctoral degree in the biomedical sciences.

To be considered eligible for the Summer Bridge to the Beach program, the transfer student needs to be currently enrolled at either a 2-year or 4-year institution upon applying, have been accepted and enrolled at CSULB for the fall semester following program participation, and declared a STEM major in either the College of Engineering or Natural Sciences and Mathematics once at CSULB. In addition, the student must be Hispanic/Latino and should be available during program dates. Some of the benefits for the student are hands-on research with a faculty from their major, opportunity to build a network and research community with faculty and other students, professional development workshops, opportunity to travel to a STEM-centered conference, and a \$4,000 stipend. The Summer Bridge to the Beach is a 9-week program for incoming Latino STEM transfer students. In the program's first week, students attend an intensive one week orientation, which includes a brief introduction to the CSULB campus and to a multitude of student services offered by the Learning Assistance Center, the Career Development Office, campus library, and college specific academic resource centers — "Student Access to Science" (SAS) Center and "Engineering Student Success Center" (ESSC). In addition, students are provided with research- focused trainings that include laboratory safety, professional responsibility and ethical conduct in research, and how to properly keep a laboratory notebook. The academic development workshops include time management, study skills, understanding a scientific article, library use, and preparing a poster and a presentation. The professional development workshops offered are Resume Writing, Latino Leadership in STEM, Leadership Skills and Development, and Careers in STEM. In the second week students start researching with their faculty mentor. A program requirement is that students attend weekly brown bag workshops throughout the 8 weeks to further connect them, facilitate their transition to the campus, and to foster a Latino student research culture. Brown Bag workshops include Scientific Writing, Abstract Preparation, Graduate School Preparation, Oral Presentations, Scientific Computing, and an Introduction to Minority Programs and Opportunities to be Involved at CSULB. At the conclusion of the program, the students present their research and experiences at a recognition event to which both the faculty mentors and parents are invited.

### **The Winter Research Experience**

The Winter Research Experience Program (WREP) matches Latinos seeking a STEM baccalaureate degree with research-active faculty who engage and mentor them in research in

the student's respective major. The program originated as a concerted effort by the Physics department to recruit students into the major. The goal was to immerse students in a positive research experience that fostered strong mentoring from faculty who engages and encourages students to apply their academic knowledge to research projects. This idea evolved into the Winter Research Experience.

While there are similarities with The Summer Bridge To The Beach, the WREP started as a three-week intensive experience to take place during the break between fall and spring semesters. This program is tailored for CSULB Latino students who are enrolled at CSULB and have completed most of their lower-division course requirements. The program presented challenges in the three-week format, one of the most impactful being that many interested faculty were not available during the time the program takes place. Due to changes in the academic calendar leading to a shorter break, the success of the summer program, and considering feedback from faculty mentors, effective Winter 2014, the WREP is being reorganized as a two-month commitment that starts in the winter break. These changes will provide students and faculty more time to strengthen their working relationship. A future publication will consider the effects that such changes have on the outcomes of this program.

The WREP application process starts with a marketing campaign in the Fall semester to try to reach as many CSULB Latino STEM students as possible. Announcements are distributed by CSULB's course management system, Facebook, and the HSI STEM website<sup>8</sup>. In addition, faculty who have participated in the HSI STEM program have been effective in identifying strong candidates. In the application, students provide demographic and academic information; they also include transcripts and a personal statement. In the personal statement, students describe why they selected a STEM major, their career goals, and how the program can help them reach their goals. Applicants are first evaluated according to their academic strengths and weaknesses by reviewing their academic standing and the grades earned in STEM courses. In the academic information submitted, students need to demonstrate their research readiness and in their personal statement, students provide additional information regarding how a research experience fits in their educational and professional goals. The WREP reaches out to STEM faculty from both participating colleges to submit an interest form in which they indicate the research experience they can offer the students. To be considered, the program looks for faculty who have an active research project and who have shown an interest in serving as research mentors to the participating students. Ideally, the program also looks to find faculty members who already have a research team of other students or who can mentor two of the WREP students. Preference is given to such faculty as this places the WREP students in a dynamic environment with other collaborators, possibly even peers in the same research project, thus minimizing the possibility of a student working in isolation. Much like the summer program, the WREP starts with orientation sessions where students are presented with workshops on responsible and ethical conduct in research, keys to professional resumes and effective personal statements, research literature search in the library, careers and internships in STEM. Icebreakers and other activities are part of the orientation and they are meant to create bonds with the cohort of students with the objective of increasing students' sense of belonging. Finally, the orientation ends with a panel discussion about the research experiences from students who have previously participated in the program.

The Winter Research Experience has two major objectives. The first is to increase the success of Latino students in STEM courses by engaging them in a research experience where they apply knowledge acquired through their completed courses. The second is to increase retention of Latino students in STEM fields by participation in the research experience and by connecting them to a faculty mentor and other students in their major.

### **Methodology**

Both programs utilized a pre- and post-program survey design. The surveys contained demographic variables, variables to aid long-term follow up, and items from validated scales<sup>3</sup> to assess learning gains and aspects of the programs (e.g., evaluation of program and mentors). Pre- and post-program surveys were administered online using Qualtrics software. Web page links for the pre-survey were sent via email by program staff to students prior to the start of either program. Similarly, a link for the post-survey was sent out to students following their participation in the programs (within one day from last day of the program). Responses for all surveys were downloaded and analyzed using SPSS by the evaluator. Datasets for each program were merged across study years for each program. Open-ended responses were read and categorized. The sections below report on the 2013 Winter Research Experience and on two occurrences of the Summer Bridge To The Beach program in 2012 and 2013.

### **Winter Research Experience Results**

A total of 21 students enrolled in the 2013 Winter Research Experience program, the majority were female (66.7% female and 33.3% male). Most of the students reported living in a parent's home (85.7%) and being first-generation educated (85.7%). Seventeen of the students reported seeking a degree from the College of Natural Sciences and Mathematics (CNSM), two reported the College of Engineering (COE), and two reported both CNSM and COE (e.g., chemical engineering and mathematics). All but one were full-time students.

The majority of students reported that they did not possess any prior research experience (76.2% or 16 students), while three students reported possessing a prior research experience in the summer (14.3%), 1 student reported prior research experience during a previous academic semester (4.8%), and another student reported having prior research experience throughout multiple academic semesters. At pre-program, students reported their future plans that involved post-undergraduate education in a science-related field. Almost all students reported plans for pursuing post-graduate education (95.2%). Specifically, 42.9% reported master degree, 33.3% reported doctoral degree, 19.0% medical degree. At post-program, there were no discernible changes to future plans.

Table 1 displays mean and median for some questions regarding students' motivation to conduct research. A series of paired sample t-test were conducted to compare research motivation to conduct research at pre- and post-program. Results indicate that no significant differences were observed in any of the questions, the table shows just a sample of these questions.



Table 1. Mean responses for motivation to conduct research (N = 21)

	Pre	Post
	Mean (Median)	Mean (Median)
I want to do research to:		
gain hands-on experience in research	4.8 (5)	4.9 (5)
clarify whether graduate school would be a good choice for me	3.7 (4)	4.0 (4)
clarify whether I wanted to pursue a science research career	3.8 (4)	3.9 (4)
work more closely with a particular faculty member	3.8 (4)	4.2 (4)
get good letters of recommendation	4.3 (5)	4.5 (5)
have a good intellectual challenge	4.6 (5)	4.8 (5)

*Note:* Strongly disagree = 1, Disagree = 2, Neither Disagree or Agree = 3, Agree = 4, Strongly Agree = 5

Similarly, students provided responses to several questions regarding research and academic goals. In most cases, there is general agreement with the statements at pre-program and higher levels of agreement are reported at post-program; 17 out of 21 items indicate post-program responses on average were higher than pre-program responses, some of these are highlighted below. Noteworthy are the increases in responses to items about their ability to interpret results, readiness for more demanding research, understanding the research process, and understanding of career opportunities. Table 2 displays averages for these responses.

**Students' Perspectives of the Winter Research Experience.** In terms of the research environment, most students worked with a team of other students. Specifically, 57.1% reported working on projects with other undergraduate students, 28.6% reported working with both undergraduate and graduate students on projects, 9.5% reported working only with graduate students on projects, and 4.8% reported working individually. Students were asked to evaluate their expectations regarding the Winter Research Experience program. Most of the students (80.9%) reported that the research experience either met or surpassed their expectations. Specifically, 38.1% reported that the experience was “much better” than expected, 28.6% reported that the experience was a “little better” than expected, 14.3% reported the experience met their expectations, and lastly 19.0% reported that the experience was “a little worse” than expected. In terms of skills or research-related experiences gained from the program, results varied greatly between students (i.e., from “none” to “a great deal”) with most responses indicating that students gained “a fair amount” of experience in many research-related domains. Table 3 displays averages for these responses.

Table 2. Mean responses for research knowledge (N = 21)

	Pre	Post	t-test
	Mean	Mean	
I have a clear career path	3.8	3.9	0.525
<b>I have skill in interpreting results</b>	<b>3.8</b>	<b>4.2</b>	<b>3.286**</b>
I have tolerance for obstacles faced in the research process	4.1	4.3	1.164
<b>I am ready for more demanding research</b>	<b>3.8</b>	<b>4.3</b>	<b>2.586*</b>
I understand how knowledge is constructed	3.8	4.2	2.007
<b>I understand the research process in my field</b>	<b>3.2</b>	<b>4.2</b>	<b>4.264***</b>
I have the ability to integrate theory and practice	3.6	4.1	2.911**
<b>I understand how scientists work on real problems</b>	<b>3.3</b>	<b>4.1</b>	<b>3.074**</b>
I understand that scientific assertions require supporting evidence	4.5	4.5	0
I have the ability to analyze data and other information	4.4	4.2	0.826
I understand science	4.3	4.3	0.326
I have learned about ethical conduct in my field	4.3	4.8	2.447*
I have learned laboratory techniques	4.3	4.7	2.007
I have an ability to read and understand primary literature	4.1	4.2	0.719
<b>I have skill in how to give an effective oral presentation</b>	<b>3.6</b>	<b>4.2</b>	<b>3.081**</b>
I have skill in science writing	3.2	3.5	1.156
I have self-confidence	4.1	4.4	2.5*
I understand how scientists think	3.8	4.1	1.919
I have the ability to work independently	4.3	4.4	0.623
I am part of a learning community	4.7	4.6	0.271
<b>I have a clear understanding of the career opportunities in science</b>	<b>3.9</b>	<b>4.4</b>	<b>2.007</b>

Note: Strongly disagree = 1, Disagree = 2, Neither Disagree or Agree = 3, Agree = 4, Strongly Agree = 5; Note: \*p < .05 \*\* p < .01 \*\*\*p < .001;

Table 3. Mean responses for experiences gained from WRE (N = 21)

During your research experience, how MUCH did you:	Post
	Mean (Median)
Engage in real-world science research	3.9 (4)
Feel like a scientist	3.8 (4)
Think creatively about the project	3.9 (4)
Try out new ideas or procedures on your own	3.5 (4)
Feel responsible for the project	3.6 (4)
Work extra hours because you were excited about the research	3.8 (4)
Interact with scientists from outside your school	1.8 (1)
Feel a part of a scientific community	4.0 (4)

*Note:* None = 1, A Little = 2, Some = 3, A Fair Amount = 4, A Great Deal = 5

**Students' evaluation of their supervisor(s).** The majority of students reported that their primary supervisor was a CSULB professor (76.2%). Only 5 students reported that their primary supervisor was a graduate student (23.8%). In terms of performance, more than half reported that their supervisor was an outstanding mentor and teacher (57.1% ), some reported that their supervisor was "above average" (14.3%), some reported that their supervisor was "about average" (9.5%) and some reported that their supervisor was "below average" (14.3%). In addition, students reported on various questions regarding their working relationship with their mentor and time spent engaged in research. Again, responses varied between students with some reporting mostly "fair" to "excellent" experiences. "Poor" ratings (a frequency of 3) were only observed for the last item regarding advice given about careers or graduate school. These results indicate an opportunity to improving the mentoring provided by faculty, increasing the pool of faculty mentors, and to try to determine the links between these responses and the responses provided by students on other surveys. Average responses are presented in Table 4.

Table 4. Mean responses regarding working relationship with mentor and research engagement (N = 21)

	Post
	Mean (Median)
My working relationship with my research mentor	3.6 (4)
My working relationship with research group members	3.7 (4)
The amount of time I spent doing meaningful rese	3.5 (4)
The amount of time I spent with my research mentor	3.2 (3)
The advice my mentor provided about careers or graduate school	3.2 (4)

*Note:* Poor = 1, Fair = 2, Good = 3, Excellent = 4

**Implications** regarding the Winter Research Experience. Students reported on various questions regarding their future research plans. Most students (90.5%) reported that the research experience confirmed their interest in their respective fields of study. However, two students strongly disagreed with this statement. In terms of the research program impacting their preparation for advanced coursework or thesis work, the responses varied. Almost half of the students agreed (“strongly agree” and “agree”) with the statement (47.6%), less than half reported “neither agree nor disagree” (47.6%), and few reported disagreement (9.5%). Similarly, almost equal number of students felt that the experience prepared them for graduate school while others did not. Another similar trend was observed for the research experience preparing them for a job. Responses are presented Table 5 for each item.

Table 5. Mean responses for outcomes related to the research experience (N= 21)

	Post
	Mean (Media)
Doing research confirmed my interest in my field of study	4.3 (4)
Doing research clarified for me which field of study I want to pursue	3.9 (4)
My research experience has prepared me for advanced coursework or thesis work	3.6 (4)
My research experience has prepared me graduate school	3.3 (3)
My research experience has prepared me for a job	3.5 (3)

*Note:* Strongly disagree = 1, Disagree = 2, Neither Disagree or Agree = 3, Agree = 4, Strongly Agree = 5

Students’ **overall evaluation** of the Winter Research Experience program was assessed. Overall, students had a positive experience. More than half reported the program was “excellent” (57.1%), “good” (28.6%), and “fair” (14.3%). None of the students selected “poor” as a response. In terms of satisfaction, half of the students reported that they were “very satisfied” (50%), more than one-third reported “mildly satisfied” (35.0%), and less reported feeling “neutral” (15.0%) about the experience. Lastly students were asked if they would choose to have another research experience. All but one student reported that they would likely seek out another research opportunity (95.2%); one student reported “not applicable”.

## Summer Bridge to the Beach Program Results

### *Demographics*

A total of 19 students enrolled in the Summer Bridge to The Beach program. The majority were male (68.4% male and 31.6% female), most indicated living in a parent’s home (78.9%), and reported being first-generation educated (83.3%). In terms of the college associated with their degree program, 36.8% reported the College of Natural Sciences and Mathematics (CNSM), 57.9% reported the College of Engineering (COE), and 5.3% reported other. Of those that answered (n = 11), all were full-time students.

### *Pre- and Post-Program Surveys*

The majority of students reported that they did not possess any prior research experience (78.9%). However, some students reported possessing a prior research experience in the summer (15.8%), and prior research experience in the summer (15.8%), and prior research experience throughout one academic semester (5.3%). At pre-program, students reported their future plans that involved post-undergraduate education in a science-related field. Almost all students reported plans for pursuing post-graduate education (94.4%). Specifically, 55.6% reported master degree, 33.3% reported doctoral degree, 5.6% medical degree, and 5.6% reported not considering post-undergraduate education. At post-program, changes to future plans were observed. Specifically, there was a substantial shift in interest from a master degree (44.4%) towards a doctoral degree (50.0%), while there was no change in interest for medical degree (5.6%).

Table 6 displays mean and median for some of the questions regarding students' motivation to conduct research. A series of paired sample t-test were conducted to compare research motivation to conduct research at pre- and post-program. While scores tended to be lower at post, results indicate that no significant differences were observed with the exception of exploring interest in science,  $t(18) = -2.535$ ,  $p < .05$  which decreased at post-program.

Table 6. Mean responses for motivation to conduct research (N =19)

	Pre	Post
I want to do research to:	Mean (SD)	Mean (SD)
gain hands-on experience in research	4.9 (0.2)	4.7 (0.6)
clarify whether graduate school would be a good choice for me	4.16 (1.0)	3.93 (0.9)
clarify whether I wanted to pursue a science research career	3.6 (1.4)	3.73 (1.2)
work more closely with a particular faculty member	4.0 (1.2)	3.6 (1.2)
get good letters of recommendation	4.55 (0.6)	4.22 (1.1)
have a good intellectual challenge	4.8 (0.4)	4.7 (0.7)
have a good intellectual challenge	4.8 (0.4)	4.7 (0.7)

Note: Strongly disagree = 1, Disagree = 2, Neither Disagree or Agree = 3, Agree = 4, Strongly Agree = 5

Similarly, students provided responses to several questions regarding research and academic goals. In most cases, there is general agreement with the statements at pre-program and higher levels of agreement are reported at post-program (i.e., 12 out of 21 items indicate post-program responses on average were higher than pre-program responses, some of these are highlighted below). Table 7 displays averages for these responses and t-test statistics.

Table 7. Mean responses for research knowledge (N = 19)

	Pre Mean	Post Mean	t-test
I have a clear career path	3.6	3.7	-0.271
I have skill in interpreting results	3.9	4.1	-1
I have tolerance for obstacles faced in the research process	4.4	4.3	0.697
I am ready for more demanding research	4.0	4.1	-0.524
I understand how knowledge is constructed	3.8	4.1	-1.564
<b>I understand the research process in my field</b>	<b>3.6</b>	<b>4.0</b>	<b>-1.719</b>
I have the ability to integrate theory and practice	3.9	4.2	-1.837
<b>I understand how scientists work on real problems</b>	<b>3.5</b>	<b>4.2</b>	<b>-2.585*</b>
I understand that scientific assertions require supporting evidence	4.7	4.5	0.9
I have the ability to analyze data and other information	4.4	4.0	2.388*
I understand science	4.1	4.1	0.294
I have learned about ethical conduct in my field	4.3	4.2	0.187
I have learned laboratory techniques	4.1	4.2	-0.357
I have an ability to read and understand primary literature	4.1	4.1	0
I have skill in how to give an effective oral presentation	4.0	3.9	0.271
I have skill in science writing	3.7	3.5	0.566
I have self-confidence	4.3	4.2	0.825
<b>I understand how scientists think</b>	<b>3.7</b>	<b>4.1</b>	<b>-1.555</b>
I have the ability to work independently	4.6	4.7	-0.809
I am part of a learning community	4.2	4.5	-1.837
I have a clear understanding of the career opportunities in science	4.0	4.2	-1.166

Note: Strongly disagree = 1, Disagree = 2, Neither Disagree or Agree = 3, Agree = 4, Strongly Agree = 5; Note: \*p < .05

*Students' perspectives of the Summer Bridge to The Beach program.* Students were asked to evaluate their expectations regarding the program. Most of the students (83.3%) reported that the research experience either met or surpassed their expectations. Specifically, 44.4% reported that the experience was “much better” than expected, 22.2% reported that the experience was a “little better” than expected, 16.7% reported the experience met their expectations, and lastly 16.7% reported that the experience was “a little worse” than expected. In terms of skills or research-related experiences gained from the summer program, experiences varied greatly between students (i.e., from “none” to “a great deal”) with most responses indicating that students gained “a fair amount” of experience in many research-related domains. Table 8 displays responses for these items.

Table 8. Frequency and percentage of responses to students' engagement with research (N = 19)

	None	A Little	Some	A Fair Amount	A Great Deal	Total Responses
Engage in real-world science research	2 (11.8%)	1 (5.9%)	0	6 (35.3%)	8 (47.1%)	17
Feel like a scientist	1 (5.6%)	2 (11.1%)	5 (27.8%)	2 (11.1%)	8 (44.4%)	18
Think creatively about the project	0	1 (5.6%)	0	7 (38.9%)	10 (52.6%)	18
Try out new ideas or procedures on your own	0	1 (5.3%)	2 (10.5%)	7 (36.8%)	9 (47.4%)	19
Feel responsible for the project	0	0	2 (10.5%)	5 (26.3%)	12 (63.2%)	19
Work extra hours because you were excited about the research	2 (10.5%)	1 (5.3%)	3 (15.8%)	6 (31.6%)	3 (15.8%)	18
Interact with scientists from outside your school	11 (61.1%)	2 (11.1%)	2 (11.1%)	1 (5.6%)	2 (11.1%)	18
Feel a part of a scientific community.	0	4 (22.2%)	2 (11.1%)	3 (16.7%)	9 (50%)	18

*Students' evaluation of their supervisor(s).* The majority of students reported that their primary supervisor was a CSULB professor (66.7%). Only 3 students reported that their primary supervisor was a graduate student (16.7%) and 1 student reported a "postdoc". In terms of performance, over one-third reported that their supervisor was an outstanding mentor and teacher (36.8%), an equal number reported that their supervisor was "above average" (21.1%) or "about average" (21.1%), some reported that their supervisor was "below average" (15.8%), and 1 reported that their supervisor was "not a good teacher and mentor." In addition, students reported on various questions regarding their working relationship with their mentor and time spent engaged in research. Again, responses varied; some reported mostly "fair" to "excellent" experiences. "Poor" ratings (a frequency of 3) were only observed for the last item regarding advice given about careers or graduate school. As with the WREP, the program recognizes the critical role of faculty mentors in the experience students receive and steps may need to be taken to provide faculty mentors with best practice mentoring techniques that the "outstanding mentors" use. Average responses are presented in Table 9.

Table 9. Mean responses regarding working relationship with mentor and research engagement (N = 19)

	Post
	Mean (Median)
My working relationship with my research mentor	3.1 (3)
My working relationship with research group members	3.5 (4)
The amount of time I spent doing meaningful research	3.2 (4)
The amount of time I spent with my research mentor	2.7 (3)
The advice my mentor provided about careers or graduate school	3.1 (3.5)

Note: Poor = 1, Fair = 2, Good = 3, Excellent = 4

*Implications regarding the Summer Bridge to The Beach.* Students reported on various questions regarding their future research plans. Most students (84.2%) reported that the research experience confirmed their interest in their respective fields of study. However, three (15.8%) students disagreed with this statement. In terms of the research program impacting their preparation for advanced coursework or thesis work, the responses varied. More than half of the students agreed (“strongly agree” and “agree”) with the statement (63.2%), less than one-quarter reported “neither agree nor disagree” (21.1%), and less reported disagreement (15.8%). Almost half of the students felt that the experience prepared them for graduate school (47.3%) while others did not. The majority reported that the research experience prepared them for a job (68.5%). Responses are presented in Table 10 for each item.

Table 10. Mean responses for outcomes related to the research (N = 19)

	Post
	Mean (Median)
Doing research confirmed my interest in my field of study	3.7 (4)
Doing research clarified for me which field of study I want to pursue	3.5 (4)
My research experience has prepared me for advanced coursework or thesis work	3.8 (4)
My research experience has prepared me graduate school	3.3 (3)
My research experience has prepared me for a job	3.8 (4)
<i>Note:</i> Strongly disagree = 1, Disagree = 2, Neither Disagree or Agree = 3, Agree = 4, Strongly Agree = 5	

*Students’ overall evaluation of the Summer Bridge to the Beach program was assessed.* In terms of satisfaction, more than half of the students reported that they were “very satisfied” (68.4%), “mildly satisfied” (5.3%), feeling “neutral” (15.8%) about the experience, and 2 students were mildly dissatisfied (5.3%) or very dissatisfied (5.3%). Lastly students were asked if they would another research opportunity (82.3%) while 3 students reported “unlikely.”



## Conclusions

There have now been two successive years of each of the research experience programs. This paper has reported some of the preliminary results from pre and post surveys used to measure the effectiveness of these programs. As is the case with research opportunities, the two research programs rely heavily on the faculty hosting the students to provide a positive experience. As evident from the responses, most of the students do not have prior research experience, yet, their expectations of the program and of a research experience may not be consistent with those of the faculty mentors. While many of the students had a positive experience, more may be needed at the start of each program to recalibrate the expectations of students and of faculty mentors. While it is still early to draw strong conclusions, there are early signs that the programs make a positive impact on students and faculty mentors. For example, there were gains in (a) the research skills acquired, (b) ability to work independently, (c) understanding how knowledge is constructed, and (d) readiness for more demanding research. There was even an increase in interest in doctoral degrees. Further analysis is needed to determine if these indicators of success are specifically linked to the type of mentoring relationship students had with their faculty mentor and research peers. As these research experience programs continue to be offered, more student participants will provide additional data that can be analyzed. Future analysis needs to link this data with the pre and post participation data on academic performance of the participants.

## Acknowledgments

The CSULB HSI STEM program is supported by a grant from the US Department of Education through the FY 2011 Title III, Part F, Hispanic Serving Institution (HSI) STEM and Articulation Programs (Award No. P031C110151). <http://www2.ed.gov/programs/hsistem/index.html>.

## Bibliography

1. Hurtado, S., Newman, C. B., Tran, M.C., & Chang, M. J. (2010). Improving the rate of success for underrepresented racial minorities in STEM fields: Insights from a national project. In S. R. Harper & C. B. Newman (eds.), *New Directions I Institutional Research*, 148, pp. 5-15, Wiley Periodicals.
2. Bonous-Hammarth, M. Pathways to Success: Affirming Opportunities for Science, Mathematics, and Engineering Majors. *Journal of Negro Education*, 2000, 69 (12), 92-111.
3. Lopatto D. Survey of Undergraduate Research Experiences (SURE): First Findings. *Cell Biology Education*. 2204; 3: 270-277.
4. Barlow, A.E.L., and Villarejo, M. Making a Difference for Minorities: Evaluation of an Educational Enrichment Program. *Journal of Research in Science Teaching*, 2004, 41 (9), 861-881.
5. California Postsecondary Education Commission. 2004. *Transfer Pathways: Student Profiles*. Sacramento: Transfer Pathways. California Postsecondary Education Commission. From <http://www.cpec.ca.gov/OnLineData/>
6. Rivas, M. A., Perez, J., Alvarez, C. R., and Solorzano, D. G. 2007. *Latina/o Transfer Students Understanding the Critical Role of the Transfer Process in California's Postsecondary Institutions*. CSRC Research Report No. Los Angeles: UCLA Chicano Studies Research Center Press.
7. California State University Long Beach. NIH Bridges To The Baccalaureate Program. <http://www.csulb.edu/colleges/cnsm/sas/bridges>
8. California State University Long Beach. Hispanic Serving Institution STEM website. <http://csulb.edu/programs/hsi-stem/>

## **First-year Experience for Engineering Lab Course: The Mini-Rose Parade Float Project Update – Year 6**

Jody Hamabata  
California State Polytechnic University, Pomona

### **Abstract**

This paper discusses how our university integrates the Cal State’s “learn by doing” philosophy into the curriculum by combining both a lecture and lab to prepare students for careers in engineering through hands on activities. Each Winter Quarter, each EGR 100 Lab section is given the task of designing and building a miniature Rose Float. Under given specifications the class brainstorms along the actual Rose Parade theme. Each section is required to follow specifications for the design of their floats and the animations. Some of the specifications included size, speed, number of animations, and decorations. There is a detailed specification sheet and a rubric used by the judges to score the mini rose floats in the competition. Each class uses 3D modeling tools to develop the design, and to develop and improve 3D spatial visualization skills, which is key to their success as engineering students. The “Learn by Doing” project experience takes a project from concept to completion, very similar to what he or she would do in the field as an engineer. At the end of the four-week project a competition is held and the floats are judged during a parade of the completed mini-rose parade floats.<sup>1</sup>

### **Introduction**

EGR100Lab is a one-unit class that meets once a week for 2 hours and 50 minutes. It is typically taken after or concurrently with the lecture component of the class, which is 3 units. Participants in this course will learn how to develop projects or a lab congruent to a lecture to better prepare students for careers in engineering as well as participate in student leadership, communication, problem solving, and teamwork skills.<sup>1</sup> Each year since 2009, Cal Poly has hosted the mini-rose parade float competition with all the sections of EGR 100 Lab during the Winter Quarter. Class size is from 20 to 25 students, with 90% of those students freshmen engineering students. The engineering disciplines include Aerospace, Chemical, Civil, Mechanical, Electrical, Computer, Industrial, Manufacturing, and Engineering Technology.

### **Procedure**

The specifications and rubric for the mini-float are developed each year by a group of professors who teach the lab during the Winter Quarter. Each year the group of 5 to 7 professors review and modify the previous year’s specifications. This year there were six professors teaching 10 sections of EGR100 Lab. The float speed was changed from 4 feet per minute to 5 feet per minute. The theme for the 2015 Rose Parade was announced on January 15th and this theme is the one used for the mini-rose parade float. Shown on the following pages are the specifications and rubric for the 2014 mini-float competition. The competition date is set for a Thursday, during university hours, so that all students are able to attend. Students are given 4 weeks to complete the project.

## Specifications

### *Mini-rose parade float project – EGR100L Winter2014*

The EGR 100L students shall undertake a class project to design and build a functional model of a parade float similar to those constructed for the annual Rose Parade in Pasadena, CA, on New Year's Day. This effort shall be implemented by teams of students responsible for one or several aspects of the float, with continued overall class meetings to coordinate the efforts relative to the finished product. Materials shall be both at the discretion of the group and as specified by the instructor. The theme for the float designs shall be "Inspiring Stories." The mini-rose float parade route is 30 feet long. There is a speed bump at 10 feet and a bridge at 20 feet.

### *Mini-rose float specifications*

1. The overall envelope of the float shall be 24 inches maximum in length, 12 inches maximum in width, and be capable of traveling under a bridge that has a 12 inch clearance. These dimensions are checked before the parade and can change once the float is in motion.
2. A motor, powered by batteries, with an on/off switch, shall power the float. Students are responsible for making sure the batteries are charged prior to the parade competition.
3. The float shall travel at a rate of five feet per minute, plus or minus, so that the 30-foot parade route is completed in 6 minutes. Lower points will be earned for floats that travel too fast or too slow, or that need to be pushed.
4. The model should travel in a straight line, without steering. Lower points will be earned for floats that need to be touched by a team member to keep them in line.
5. The model must pass over a ½ inch high speed bump without assistance. Lower points will be earned for floats that need assistance to pass over the bump.
6. Commercially available building kits are not allowed. The float will be built from scratch, including decorations. Mini-figures such as ready-made dolls and models are not allowed. Lower points will be earned for floats that do not follow these rules.
7. Any items in question can be submitted to the team of EGR100L instructors for approval.
8. Remote control is not allowed.
9. The float shall contain a minimum of three (3) separate animated displays. The float with all animations shall fit within the above envelope.
10. The separate animation displays shall be powered by motors and 1.5-volt batteries. Each animation will have an on/off switch.
11. At least part of the float must be decorated with items found in nature.
12. The instructor shall approve the float covering and decorating materials.
13. The maximum amount that a team may spend is \$60 total per float. There will be no reimbursement.

EGR 100L – Winter 2014 Rose Float Project Assessment Rubric "Inspiring Stories"						
Date: 6 March 2014						
Evaluator:						
Team:						
	Excellent (5)	Good (3)	Needs Improvement (0)	5	3	0
Size (length, width, height)	Correct dimensions and fits under bridge	Too big or too tall	Too big and too tall			
Speed	5 feet/min (completes course in 6 minutes)	Too slow or too fast	Does not move, needs to be pushed			
Negotiates bump	Goes over smoothly	Goes over with difficulty	Requires help			
Lateral dispersion	Goes straight	Deviates from straight line	Strays outside boundaries			
Animation 1	Performs an interesting motion, creative ideas	Works	Doesn't work			
Animation 2	Performs an interesting motion, creative ideas	Works	Doesn't work			
Animation 3	Performs an interesting motion, creative ideas	Works	Doesn't work			
Completes route	Finishes	Drops out after bridge	Drops out after bump			
Overall creativity	Very clever	Interesting	Plain			
Overall look	Beautiful	Looks good	Plain			
Overall functionality	Works well	Needs help	Does not work			
Starts without push within 1 minute	Starts within 1 minute	Needs help	Does not start			
Budget	Cost summary provided and meets \$60 budget	Cost summary provided and exceeds \$60 budget	No cost summary provided			
Total Score						
Comments:						

Figure 2. Mini-rose parade float project assessment rubric

During the 5th week of the quarter the students are given the specification and rubric for the mini-float project and the engineering design process starts. Taking a project from concept to finished project in a limited timeframe in a first year engineering course, provides students with a great opportunity to develop their skills:

- Brainstorming to generate concept ideas
- Concept selection
- Open-ended problem solving (i.e., how to fit three animations within the specified float size)
- Generating concept visualization through the use of 3D tools like SolidWorks, Blender, Inventor or SketchUp
- Time and Project Management – setting key completion dates and times
- Managing a budget

The class is one big team working towards the same goal; within the larger team are several smaller teams along with an overall project team leader and a finance person:

- Animation 1 Team
- Animation 2 Team
- Animation 3 Team
- Design Team
- Drive Train Team

### **Results and Discussion**

The students involved in this project develop life-long learning skills by exploring new areas of thinking outside the box, and finding solutions not as individuals but as a cohesive team of future engineers.<sup>1</sup> They discover their own skills as well as those of their classmates. Their teammates bring prior knowledge into the process in the form of new ideas and creativity to enhance the overall project. They learn and utilize the full design process as described in Landis' third edition of *Studying Engineering, A Road Map to a Rewarding Career* to optimize their design.<sup>2</sup> Sorby and Baartmans have developed specific courses to help improve 3D spatial visualization in first-year engineering students; their results have shown higher retention rates for engineering students who have participated in their course, particularly females who consistently score lower on the pre-test evaluation than their male classmates.<sup>3</sup> Blender, an open source software, has been used in India and SketchUp has been used in Spain to help improve spatial visualization for first-year engineering students. Both studies found that instruction using Blender or SketchUp for enhancing 3-D spatial skills is beneficial and engaging for the students, particularly female engineering students.<sup>4,5</sup> And finally students develop teamwork and interpersonal skills that will service them as they progress through their engineering studies and on to their future careers.

### **EGR100L Winter 2014 – End Survey**

Students completed a survey at the end of the quarter. This year's results showed an average of 7% increase in agreement to the statements in the survey versus the same survey given last year. The results of this survey clearly indicate that the students benefitted from this project; hence this project has become a repeat event each winter quarter at Cal Poly Pomona. Students were also asked to respond to the following prompt:

Name one thing you learned in this course that was most useful for you (if anything).<sup>6</sup> Some common themes:

- The importance of teamwork
- Leadership
- Time, budget, and project management
- Wiring and soldering motors, batteries, and a switch
- Communication and cooperation across teams
- Motors and gears

The design team used SketchUp to create a concept drawing, like that shown in Figure 2, then the other teams developed each of their animations and drive train to meet the specifications stated in the beginning of this report and sized the animations according to the concept drawing provided by the design team.

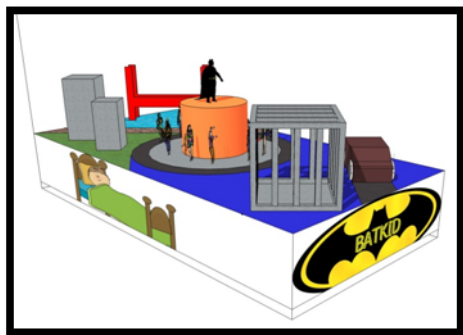

Figure 2. Concept.

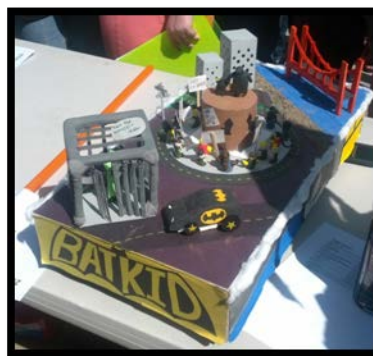

Figure 3. Finished product

The design team worked closely with each of the animation and drive train teams to finalize the placement of each animation (motor, battery pack, and switch) and the drive train (wheels, axles, frame, motor, battery pack, and switch), which was placed underneath the float. The team leader's role was to keep each team on task, and to assist with communication between each team. The team leader also worked closely with the finance person to get the needed materials purchased, and the communication to each team to assure the mini-float was within the specified budget of \$60.00. The team finance person created a spreadsheet and kept track of all the expenses for the mini-rose parade float, this cost summary was provided, and was included as part of the rubric, see Figure 1, for the competition. The drive train was designed to meet the speed criteria and travel straight, but also designed with a low profile, yet still able to travel over the bump. Calculations were used to estimate speed in feet per minute, based on known rpm and wheel diameter. Each float was carefully decorated, with each motor for the animations hidden and a switch available to activate each of the animations and the drive train. Refer to Figure 3 to view the finished product.

One of the main complaints about this project was that it was primarily a mechanical engineering focus with the use of motors and gears on the drive train and animations. The 3D modeling aspect added another dimension to this project to help students visualize in all three dimensions how to get from concept to finished product while still staying within specification. The wiring and soldering skills are valuable tools for any engineering major. The selection of appropriate materials and the overall structure of the float could easily fall under civil, chemical, and aerospace engineering. Another main complaint was that the students did not have enough time, however in the end they confessed that their productivity level in the first 2 weeks of the project was very low, even though team assignments were made and a concept agreed on.

## Bibliography

1. Hamabata, J., "Extended Abstract-FYE for Engineers Lab Course The Mini Rose Float Project," In *5th First Year Engineering Experience Conference*. Pittsburgh, PA. Retrieved from <http://www.fyee.org/fyee2013/papers/1046.pdf>
2. Landis, R.B., "*Studying Engineering: A Roadmap to a Rewarding Career*," 3rd ed. Discovery Press, 2007, 38-39.
3. S.A. Sorby & B.J. Baartmans, "The Development and Assessment of a Course for Enhancing 3-D Spatial Visualization Skills of First Year Engineering Students," *Journal of Engineering Education*, 89(3), 301-307, 2000.
4. K. Kadam, S. Sahasrabudhe, & S. Iyer, "Improvement of Mental Rotation Ability Using Blender 3-D," in *2012 IEEE Fourth International Conference on Technology for Education (T4E)*, 2012, 60-66.
5. N. Martín -Dorta, J. L. Saorín, and M. Contero, "Development of a Fast Remedial Course to Improve the Spatial Abilities of Engineering Students," *Journal of Engineering Education*, vol. 97(4), 505-513, 2008.
6. Cal Poly Pomona, College of Engineering. "*EGR100L winter 2014 - end survey [pdf file]*." Survey Monkey. March 2014.

## A Brainwriting Exercise on Improving Engineering Programs

Nebojsa Jaksic  
Colorado State University, Pueblo

### Abstract

This paper describes an ideation exercise, brainwriting (a variation on brainstorming), used to improve two undergraduate programs of a small engineering department. Two generations of senior engineering students from two consecutive years as well as the engineering faculty completed the exercise. The ideas resulting from the exercise were grouped into categories, ranked, discussed at the faculty meetings, and then some of them implemented, some discarded, and some presented to the University administration as action items.

### Introduction and Previous Work

While talking about clean energy President Obama stated in his weekly address on October 2<sup>nd</sup> 2010 that “Our future as a nation depends on making sure that the jobs and industries of the 21<sup>st</sup> century take root here in America.<sup>1</sup>” The innovation productivity and quality must increase to stop the country's technological and manufacturing decline. While most engineering programs produce solid problem solvers, this may not be sufficient. The education of engineers must also enhance their inventive and entrepreneurial skills by including topics on innovation methods, disruptive technologies, intellectual property, entrepreneurship, etc. Engineering design is a crucial component of engineering practice. Most engineering students become familiar with engineering design process steps and disciplinary design methods through design-oriented engineering courses. Concept generation or ideation is a step in the engineering design process where new ideas take shape. Subject expertise coupled with general intelligence may lead to creation of new ideas (ideation). Some of these ideas may lead to innovative problem solutions or inventions. Usually, the creation of a working physical (sometimes improved) prototype ends the innovation process and starts the entrepreneurial process (commercialization). Creativity, in general, can be quantitatively measured as a number of novel ideas. In engineering, the quality (feasibility) of these ideas is also addressed. In engineering education, a number of techniques are implemented to develop creativity and enhance ideation capabilities of students. These techniques include brainstorming<sup>2</sup>, brainwriting<sup>3</sup>, collaborative sketching<sup>4</sup>, morphological analysis<sup>5</sup>, transformational design using mind-mapping<sup>6</sup>, design by analogy<sup>7</sup>, principles of historical innovators<sup>8</sup>, and various combinations of the aforementioned techniques<sup>9</sup>. Developing an ability to innovate has been approached through improvisation<sup>10</sup>, the theory of inventive problem solving (TRIZ)<sup>11-20</sup>, and the S-field (also referred as Su-field) theory<sup>21</sup>.

One of the commonly used techniques in ideation is brainstorming (especially when solving generic, non-engineering problems). Brainstorming, a group ideation method first introduced in 1963<sup>22</sup>, is well described in engineering design textbooks<sup>2, 3, 14, 15</sup>. However, there are some findings that invalidate the use of this approach. For example, McGrath<sup>23</sup> claims that a group of people working together on a problem would accomplish less (fewer and lower-quality concepts)

than if they would to work independently. Also, Lewis et al.<sup>24</sup> conclude that brainstorming is an ineffective ideation method for engineering problems. Brainwriting, also referred to as 635 brainstorming, was introduced in 1969<sup>25</sup>. According to this method, a group (six members if possible) is introduced to a problem. Each member of the group writes down the problem statement on a large sheet of paper. When all members fully understand the problem, each member is given five minutes to write three possible solutions to the problem, thus working as individuals. Then, each member passes his/her paper to the next person, who in turn is given another five minutes to improve on the solutions recorded on that piece of paper. The process repeats until all the members had a chance to improve on all ideas written. Finally, the group discusses all the ideas and decides which three ideas to recommend for further consideration.

### **Curricular Context**

At our institution, there are two undergraduate engineering programs: industrial engineering and mechatronics. Apart from disciplinary courses emphasizing design, students from both programs are required to take a two course sequence in their senior year: the Senior Seminar (two semester-credits) and the Senior Design Project (three semester-credits). In the Senior Seminar course students are introduced to some general design ideation concepts like brainstorming, brainwriting, collaborative sketching, morphological analysis, transformational design using mind-mapping, design by analogy, TRIZ, and the S-field theory. In the Senior Design Project course, students working in groups implement some of the ideation methods while creating a solution to an engineering design problem.

In the Senior Seminar course, as a part of the brainwriting exercise students are asked to create solutions to some interesting problems. In this work, senior students in two consecutive years were asked to generate ideas leading to the improvements of the engineering programs at our institution. This exercise was influenced by the two engineering programs' ABET accreditation cycle. In general, after an ABET team visits the campus, and the accreditation decision is made, the department faculty discuss and implement program and curricular changes. This allows enough time to test and validate the changes before the next ABET visit. In the past, the student input was solicited, but it was informal and voluntary. For this ABET accreditation cycle, the author implemented a brainwriting exercise for senior students and the department faculty in search of ideas to improve the department, the programs, and the curricula.

### **The Process**

The procedure of implementing a brainwriting exercise, described previously, was followed. First, the problem statement, "how to improve engineering programs at our institution," was written on the blackboard. Then, the participants were divided into six-member teams where possible. Each team member received a sheet of paper. They wrote three ideas in five minutes. After a five-minute period each paper was passed to the next team member. In the following five-minute period each team member added to the original ideas already written on the paper in front of them. This part of the exercise was finished when the papers were returned to their original owners. The next step of the exercise included rating of ideas for two problem-specific conditions, the ease of implementation and the importance of the proposed solution. Ideas were written on the blackboard, discussed, sometimes clarified, and rated. Ideas from all teams, including the faculty, were grouped in categories, discussed at the faculty meetings, some of them implemented, some



discarded, and some presented to the administration as feasible action items. In this study, there were five student groups and one faculty group. The generated ideas, an analysis, and some implementation results are presented next.

## Ideas

Three brainwriting sessions were administered. Each of the two student sessions was discussed (ranking of ideas) by the whole class. Five student groups and one faculty group with about six members per group and three ideas per member generated a large number of ideas. At each discussion session, duplicate ideas were erased and for each idea a decision was made on its quality parameters: feasibility and importance ranking. The lower the number the more important (and/or easier to implement) the idea. Figure 1 shows a photograph of the results of the Fall 2013 session as it was written on the blackboard. A sample of an idea and its derivatives from one of the brainwriting sessions is provided below.

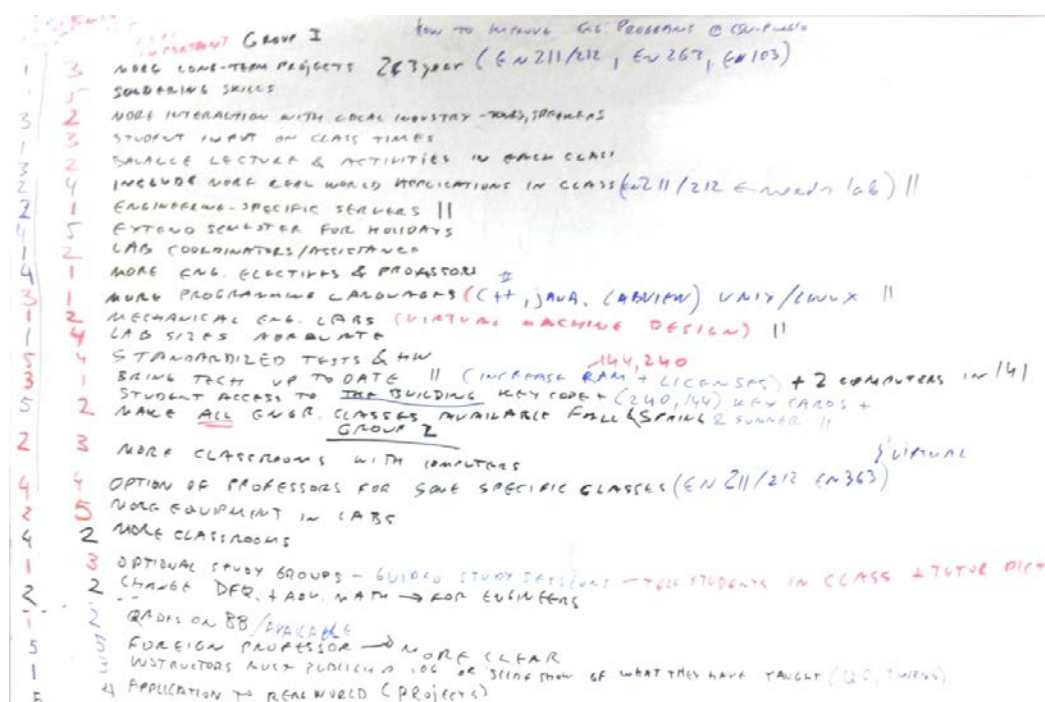

Figure 1. Ideas recorded on the board with assigned quality parameters (left).

### 2. More programming options (MATLAB, C++, Java, etc.)

- Bring the programming that we don't have up to date
- Incorporate courses that will actually help students apply programming to real life situations
- Courses should be designed to make us keep using the software we learn in previous semesters.
- Include extended programming as master's level classes
- Offer basic programming courses
- Have each class include a project involving programming so the students' abilities rise with them.

### Analysis of Results

The ideas are classified depending on the area they are addressing. The areas are the physical space and learning environment, technology, faculty matters, and engineering curricula. Then, only the ideas with an aggregate score of 2 or 3, as shown in Table 1, are discussed at the faculty meetings. When this list is exhausted, the list of ideas with aggregate scores of 4, shown in Table 2, will be discussed.

Table 1. High aggregate score ideas ( score 2 or 3).

Idea Type	F*	I**	Proposed Improvement
Physical Space			
Faculty	1	1	Manage the resources - labs, classrooms, offices, GA's
	1	2	Hire a lab coordinator
	2	1	Add staff engineer for labs
Curriculum	1	1	Develop a strategic plan
	1	1	Provide more non-book examples
	1	2	Have admission standards (for engineering)
	1	2	Have labs in virtual machine design class
	1	2	Make grades on Blackboard available
	2	1	Provide more in-class demonstrations
Technology	1	2	Install engineering software in the study room
	1	2	Fix the printer in ESR lab

\* = Feasibility: 1- easy to implement, 5 - hard to implement

\*\* = Order of importance: 1 – high importance, 5- low importance

Table 2. Medium aggregate score ideas (Score 4)

Idea Type	F*	I**	Proposed Improvement
Physical Space	1	3	Provide student input on class times
	3	1	Bring technology up to date (more computers, access to buildings/labs)
Faculty	1	3	Instructors should publish a log of slide-show of what they have taught (QC and Thermo)
Curriculum	2	2	Require a minimum ACT for admission, such as 18 or so.
	2	2	Add another programming class
	1	3	Add some long-term projects

	3	1	Have more programming languages like C++, Java, UNIX, LabVIEW
	1	3	Create optional study groups and guided study sessions and post tutors' pictures
	2	2	Change to engineering -specific differential equations and advanced math classes
Technology	2	2	Make additions to the Robotics Lab

### Resulting Actions

Some of the programmatic/curricular changes suggested in Table 1 were already in the implementation stages as this exercise was performed.

*Hire a lab coordinator/staff engineer.* Hiring a lab coordinator or a staff engineer was discussed with the administration, a half-position (sharing with Physics) was approved, and a physics PhD hired. The lab coordinator started in January.

*Manage the resources.* Management of the resources was improved. New substantial changes in our lab space are underway. They are a part of an external grant. We still have to establish some supervisory policies when working with our graduate assistants.

The largest number of changes was suggested for the curriculum/program.

*Develop a strategic plan.* Departmental strategic plan was discussed at faculty meetings. While there is a mission statement for the college we didn't have one for the department. A mission statement draft for Engineering is emerging this semester. It will define the direction for crafting of our strategic plan.

*Have admission standards.* There are already admission standards for the University. In Mechatronics, after discussions at faculty meetings, an admission process with admission standards stricter than the ones for the University admission was developed. It will be implemented the next academic year.

The next set of proposed improvements (non-book examples for mechanical courses, a lab for virtual machine design course, in-class demonstrations, and posting grades on Blackboard) is hard to implement since these changes rest with individual faculty. Posting grades on Blackboard is easy to do. Many faculty are already doing this. However, due to the extra time needed to enter the grades and the security/integrity of data issues, some faculty refuse to use this feature of Blackboard.

*Install engineering software.* Faculty were involved in negotiations with our IT department in ensuring that appropriate engineering software is loaded on all computers in the engineering study room. However, the IT response is usually sluggish at best. Now, our lab coordinator is responsible for software installations and working with the IT department.

*Fix the printer.* As soon as a faculty learned that the printer is not functioning it was replaced. Students didn't know to whom to address the problem and the faculty didn't know the problem existed. Sometimes, trivial problems like this can cause student dissatisfaction. Finally, some of the proposed improvements in Table 2 have been addressed. For example, the robotics lab received a number of 3D printers, laptops, LEGO EV3 robots, and microcontrollers in the past two years.

## Summary

In this paper, a brainwriting exercise administered to senior undergraduate engineering students and engineering faculty was used to improve two engineering programs in a small engineering department. The results of the ideation exercise were discussed among the group members. The solutions were ranked in accordance to the ease of implementation and the order of importance. The highly-ranked solutions were further analyzed by the faculty and implemented. In the future, the proposed improvements that were ranked somewhat lower will be discussed for possible implementation.

## References

1. The White House Press Office, "President Obama's Weekly Address – Oct. 2, 2010," Obama Speeches. Accessed on January 29, 2014 from <http://www.whitehouse.gov/the-press-office/2010/10/02/weekly-address-president-obama-lauds-clean-energy-projects-key-creating>
2. Ogot, M. and Kremer, G., *Engineering Design – A Practical Guide*, Trafford Publishing, 2004.
3. Brassard, M., Ritter, D., *The Memory Jogger 2: Tools for Continuous Improvement and Effective Planning*, GOAL/QPC, 2010.
4. Shah, J. J., Vargas-Hernandez, N., Summers, J. D., and Kulkarni, S., "Collaborative Sketching (C-Sketch) – An Idea Generation Technique for Engineering Design," *Journal of Creative Behavior*, Vol. 35, No. 3, pp. 168 – 198, 2001.
5. Otto, K., Wood, K., *Product Design: Techniques in Reverse Engineering and New Product Development*, Prentice Hall, 2001.
6. Singh, V., Walter, B., Krager, J., Putnam, N., Koraisky, B., Wood, K., Jensen, D. "Design for Transformation: Theory, Method and Application", *Proceedings of the IDETC/CIE 2007, ASME 2007 International Design Engineering Technical Conferences & Computers and Information in Engineering Conference*, September, Las Vegas, NV, 2007.
7. Linsey, J., Wood, K., and Markman, A., 2008, "Increasing Innovation: Presentation and Evaluation of the WordTree Design-by-Analogy Method," *Proceedings of the ASME Design Theory and Methodology Conference*, New York, NY, 2008.
8. Jensen, D. J., Weaver, J., Wood, K. L., Linsey, J., and Wood, J., "Techniques to Enhance Concept Generation and Develop Creativity," *ASEE Annual Conference*, AC 2009-2369, Austin, TX, June 2009.
9. White, C., Talley, A., Jensen, D., Wood, K., Szmerekovsky, A., and Crawford, R., "From Brainstorming to C-Sketch to Principles of Historical Innovators: Ideation Techniques to Enhance Student Creativity," *ASEE Annual Conference*, AC 2010-2278, Louisville, KY, June 2010.
10. Ludovice, P., Lefton, L., and Catrambone, R., "Improvisation for Engineering Innovation," *ASEE Annual Conference*, AC 2010-1650, Louisville, KY, June 2010.
11. Altschuller, G., *And Suddenly the Inventor Appeared – TRIZ the Theory of Inventive Problem Solving*, Technical Innovation Center, Inc., Worcester Massachusetts, 2001.
12. Clarke, D., Reimer, D., and Ali, A., "A Structured Approach to Innovation: A Classroom Experience in Inventive Problem Solving for an Entrepreneurial Program," *ASEE Annual Conference*, AC 2009-1349, Austin, TX, June 2009.
13. Camarda, C., Bilen, S., de Weck, O., Yen, J., and Matson, J., "Innovative Conceptual Engineering Design – A Template to Teach Innovative Problem Solving of Complex Multidisciplinary Design Problems," *ASEE Annual Conference*, AC 2010-1733, Louisville, KY, June 2010.

14. Ullman, D. G., *The Mechanical Design Process*, 4<sup>th</sup> edition, McGraw Hill, 2010.
15. Dieter, G. E., and Schmidt, L. C., *Engineering Design*, 4<sup>th</sup> edition, McGraw Hill, 2009.
16. Rivin, R. I., and Fey, V. R., "Use of TRIZ in Design Curriculum, Innovations in Engineering Education," *ABET Annual Meeting Proceedings*, pp. 161-164, 1996.
17. Bzymek, A., "Engineering Problem Solving in Design for Manufacturing: Applications of the Brief Theory of Inventive Problem Solving," Tutorial Workshop in 2002 ASME International Design Engineering Technical Conference, 2002.
18. Raviv, D., "Teaching Inventive Thinking," "Recent Advances in Robotics Conference, April 29-30, 1999.
19. Wang, S-L, "Developing a TRIZ Design Tool to Enhance Engineering Design Courses," *ASEE Annual Conference*, AC 2007-1842, Honolulu, HI, June 24-27, 2007.
20. Altshuller, G. S., *Creativity as an Exact Science – The Theory of the Solution of Inventive Problems*, Gordon and Breach, Science Publishers, Inc. 1984.
21. Lettieri, A. C., and Yoneyama, T., "Su-Field: An Educational Example of Inventive Problem Solving in Electrical Engineering," *TRIZ Journal*, January 2006.  
Available at: [www.triz-journal.com/archives/2006/01/05.pdf](http://www.triz-journal.com/archives/2006/01/05.pdf) (accessed 1/30/14)
22. Osborn, A.F., *Applied Imagination: Principles and Procedures for Applied Problem-Solving*, 3<sup>rd</sup> Edition, New York: Charles Scribner & Sons, 1963.
23. McGrath, J.E., *Groups: Interaction and Performance*, Englewood Cliffs, NJ: Prentice Hall, 1984.
24. Lewis, A.C., Sadosky, L, and Connolly, T., "The Effectiveness of Group Brainstorming in Engineering Problem Solving," *IEEE Transactions on Engineering Management*, Vol. EM-22, No. 3, pp. 119 – 124, August 1975.
25. Rohrbach, B., "Kreativ nach Regeln – Methode 635, eine neue Technik zum Lösen von Problemen," *Absatzwirtschaft*, Vol. 12, pp. 73-75, 1969.

## **Lessons Learned from Advanced Information Technologies on Jobsite for Construction Education**

Jin-Lee Kim and Talal Trabolsi  
California State University, Long Beach

### **Abstract**

This paper presents survey results used to identify the need for the advanced information technologies and construction activities that would benefit the most from the use of information technologies on construction sites. A survey was designed and conducted to gather a consensus of the construction industry in order to identify the perception of such technologies and their effects to professionals in the field. Twenty-one responses were received from participants in the Southern California area. The analysis results indicate that in a general consensus, the construction industry is not only dependent on the changing information technologies, but also that construction companies have discovered the efficiency developed through the implementation of such technology allows them to increase profitability and ultimately lower the potential for construction delays and undocumented issues that contractors wish to avoid at any cost. The findings will help academia develop the construction curriculum when integrating advanced information technologies.

### **Introduction**

Advanced information technology, such as Building Information Modeling (BIM), has transformed the way the construction industry operates its business practices. Many construction companies have gradually adopted newly advanced information technologies based on the company's needs. The items such as the iPad, personal mini computers, and the vast array of software available used to enhance management and design aspects of a business are all examples of advanced information technologies that have quickly become a common appearance on the construction site. Implementation of these new technological advancements has proven to increase productivity and efficiency, and also reduce cost and time on successful construction projects. The use of advanced information technologies on a construction site will definitely prove to be vital since everyday construction managers use the technologies to coordinate and communicate on the job site. In line with current construction practices, construction engineering management students need to understand current information technologies and their implementation on the actual job site in order to better prepare for future employment.

The availability of advanced information technology and its practical use on the construction site is again revolutionizing the industry through increasing productivity, efficiency, and visibility. These recent technologies will undoubtedly have a profound impact on how organizations operate on a daily basis. Advanced information technology aids in having correct documentation available at a moment's request. Being able to fill out forms, incident reports, and daily progress reports in the field increases efficiency and overall accuracy of such reports. These technologies also save time by reducing the amount of trips back and forth to the job trailer to acquire needed information,

allowing for more immediate decision making in the field. Ultimately, readily available information allows companies and project teams to reduce risk and exposure to failure as project teams will be confident that the decisions made are based on the latest most current information.

Advanced technologies and their implementation on the job site aid in the coordination and communication efforts on construction projects. The use of Building Information Modeling (BIM) in the field, having readily accessible construction documents, and being able to create and review reports in the field, will establish a level of coordination and communication that to this date has been unseen in the construction industry. The implementation of such technology will encounter many roadblocks; such as cost, training, discomfort with such changes, and commitment to the use of the technology. Although these difficulties may affect the implementation of the new technologies, the benefits will be immediately evident and the savings to projects will attract attention from all corners. Coordination in construction through the availability of information is of utmost importance. Unfortunately, proper and constructive coordination is an issue that many construction projects face. The central problem of coordination arises from the fact that the relationship between the parties on a construction project has the character element of an “interdependent autonomy.” This independent autonomy plays through the technical interdependence of the work and the organizational independence of those who control the work. For more than three centuries, the construction industry has been struggling to reconcile this technical interdependence and organizational independence (Higgin and Jessop 1965). According to Higgin and Jessop (1965), when “Looking at the building process, we can distinguish three main functions. Two are obvious: design and construction. The third is coordination.” Coordination is one of the most sensitive functions of management (Chitkara 1998).

Communication problems are frequently occurring at the construction job site, where both paper documents and electronic equipment may be easily damaged. Recently, affordable tablet and wearable computers were introduced to overcome such problems. The use of tablets and tablet computers provides a more efficient method of communication between the fieldworkers, and on-site and off-site collaborators in building design and construction. Proper communication and improvements in early phases of projects would positively influence the quality of the projects, as perceived by all stakeholders involved in a construction project (Emmit and Gorse 2003). Improved communication will lead to better decision making through proper coordination, as well as proper implementation of the design intent.

One of the oldest issues in the literature regarding the adoption of technological innovations is whether diffusion is driven more by technology-push than by demand-pull mechanisms (Nam and Tatum 1992). Similar to the wave of the computer-aided design software and now the different building information modeling software, the new integrated construction management and information technology onsite will revolutionize the industry to a place where project information is always just a few seconds away. The compelling advanced information technologies in the construction industry with sufficient economic incentives will overcome barriers and benefit each individual player in the whole supply chain. Over the next decade, the combination between technology tools and business incentives will form the core of a strategic vision for advanced information technology in construction. Therefore, this paper examines the current technology being used on the majority of construction sites, the new evolving technology, as well as the benefits and roadblocks to adopt such technology.

### **Research Methodology and Data Collection**

There is little empirical data regarding the current level of advanced information technology and the implementation of such technology on the construction site. Since there is no benchmark to be met for future improvements, a survey methodology has been implemented. The survey was generated in order to gauge professionals in the construction industry regarding their experiences with advanced information technology on the construction site. The questionnaire was formulated to derive conclusions from the professionals' past experiences, comfort and ability with current technology available, as well as any future advancements they would support. The questionnaire gave directions on how to properly answer the proposed questions and requested the participants to provide basic information regarding the industry currently worked in, years of experience in that particular industry, and the company currently employed with. The questionnaire consisted of twenty-one questions split amongst categories, and included a section for comments if the participant had any to include. The survey focused on three main areas of information technology and its implementation in the construction industry:

Part I: New technology and current use of present technologies in the field (6 questions) Part II: Improvements to current technology (12 questions)  
Part III: Future trends of technology (3 questions)

Part I of the survey was constructed to determine the level of use of current technology available in the field. This section was also geared to gauge the opinion of the participants on their openness to new, emerging technologies, and their perception of the importance of new technology to the construction industry. Part II was primarily comprised of questions that regarded how improvements in the current methodology of day-to-day tasks would affect practitioners. Questions were asked concerning how the job would change if the availability of information that one is accustomed to being in the construction onsite trailer would now be available in the field. This information would prove very valuable as perhaps some users and/or professionals in the industry may be reluctant to change their procedures for conducting business. The realization of the benefits of having such information available onsite would become very apparent in these responses. The questions proposed in Part II are directed towards all aspects of construction management and towards improving the communication level between various parties that make up a construction team. Part III, similar to Part I, was comprised of only a few questions to determine if new trends in the industry would prove helpful to users in the field. This section, again, was intended to evaluate whether or not professionals in the construction industry would welcomingly adopt new technologies in the field.

The questionnaire was distributed to construction professionals who are currently or have been employed by construction management firms or those involved with onsite construction in the Southern California area. A total 21 responses were received from the 50 surveys distributed. The survey respondents have in average 11 years of work experience in the industry. Of those responses, 62% were from the construction management industry and 38% from the architectural field. The large response from the construction management industry is due to the fact that more than half of the surveys were distributed at a construction job site. Architectural and engineering firms are typically more attuned with emerging technologies and deal daily with Computer Aided



Designs of buildings. The construction industry, largely, does not incorporate the use of such technology on a day-to-day basis. Rapid or significant changes to methodology are thereby unsupported. While new trends in the industry are moving towards adopting new management software which aid in the communication efforts onsite, its implementation and the orientation required to move forward may prove challenging for the individuals not accustomed to the use of technologies and advanced technologies.

### Analysis and Findings

Every industry adopts new technologies as they become industry common place or when individuals within that industry find it beneficial to make changes necessary to adopt new strategies or technologies. Question three in Part I of the survey proposed the statement, “The use of new advanced technologies will be costly and over complicate things unnecessary.” As shown in Table 1, of those surveyed, nearly 70% disagreed or strongly disagreed with the statement, and about 25% remained were neutral with the statement. These results signify that a very minute amount of people would disagree with the statement. This would signify that advanced technologies, in the viewpoint of industry professionals, would simplify the procedures used in managing the construction industry. In addition, this would also translate that the benefit of using such technology would outweigh the costs.

Table 1. Advanced technologies complication & cost.

Advanced technologies will be costly and over complicate the industry				
Strongly disagree	Disagree	Neutral	Agree	Strongly agree
38%	29%	24%	5%	5%

The availability of having project documents in the field is of great benefit to industry professionals who spend the majority of their time in the field. These documents allow for immediate decision making and reduce visits to the office trailer, which causes delays. In addition, when decisions are delayed in order to refer back to project documents that are located in the office trailer, there is a certain amount of human error that needs to be considered. The ability to resolve conflicts in the field when they arise is very valuable. Table 2 tabulates questions one through three of Part II of the survey. These questions focused on gauging the industry's benefit to having documents available in the field. Of those surveyed, over 85% agreed or strongly agreed that having project documents available in the field would be a benefit to their work. This indicates that of those surveyed, the majority find it beneficial in having documents available to them in the field. A construction foreman will normally have a half-set of plans to refer to while out on the project site; these plans will undoubtedly see much mistreated and, over time, will need to be replaced. Having such plans available electronically will give ease when referring to the plans and will confirm that the most current set of documents are being used to make the most accurate and sound decisions.

Table 2. Project documents in the field.

Having project documents available in the field would be a benefit to my work					
Parameter	Strongly disagree	Disagree	Neutral	Agree	Strongly agree
Request for Information	0%	5%	10%	33%	52%

Plans	0%	5%	5%	38%	52%
Specifications	0%	0%	10%	33%	57%

Part II of the survey also presented questions regarding real-time data entry of reports. The ability to create and review reports in real-time adds to the efficiency of the construction project team. Real-time reporting would allow professionals to create reports and give project status updates as they develop. Also, efficiency and accuracy of reports is improved as the project team will not lose time when going back to the office trailer to document occurrences, which may lose accuracy in the forgetfulness of the human mind. Real-time entry of reports and requests will decrease the amount of error in such reports.

Questions eleven through sixteen were presented to gauge industry professionals' point-of-view on real-time data entry at the construction project site. Table 3 displays the results of those questions. Over 70% of those asked either strongly agreed or agreed with the statement that "Real-time data entry of reports is more efficient and more accurate." This statement was presented differently over six different statements in relationship to the topic. This demonstrates that people believe the real-time process or procedure would produce positive results and prove beneficial to the construction management team. There was no overwhelming differences between the results of those six questions asked, and it is noteworthy to mention that, on average, only 5-10% of those surveyed disagreed with that statement, and not a single person surveyed strongly disagreed with the statements.

Table 3. Real time data entry.

Question	Real time data entry of reports are more efficient and accurate					Parameter
	Strongly disagree	Disagree	Neutral	Agree	Strongly agree	
reports	0%	5%	14%	55%	21%	Daily
incidents	0%	10%	21%	48%	17%	Safety
Inspection requests	0%	7%	17%	45%	26%	

Another trend in construction projects is the availability of Internet access to the construction team onsite of a project. In today's world, with the wide use of smart phones and the Internet access they provide, it is difficult to imagine a construction project site that lacks the use of Internet. Though, for tablet devices, personal laptops, or computers, the availability of a wireless network onsite will be beneficial in that information can flow freely to all of those who require it. Questions one and two of Part III address the availability of wireless Internet and the access to email to those in the field of the construction project. Of those surveyed, an overwhelming 90% agreed or strongly agreed that having Internet and email access while on a project site would prove beneficial, as shown in Table 4.

Table 4. Email and Internet access.

Wireless internet and email access on the construction site would be beneficial to my work				
Strongly disagree	Disagree	Neutral	Agree	Strongly agree
0%	2%	7%	33%	57%

## Discussion and Limitations

Throughout the process of distributing the survey to industry professionals, discussions arose

about the benefits and drawbacks that advanced technologies and their implementations can produce. Advanced information technologies provide solutions for, at times, tedious operations and procedures. These technologies simplify such tasks so that the procedural aspect of management is minimized. For example, when project architects receive or answer Request For Information (RFI), they review, answer and distribute the request to the project team. Rather than being bombarded with RFI unrelated to the scope of work, certain technologies allow teams to create alerts that when certain RFIs are answered, those alerts are sent out. This increases the efficiency of the team in that architects and construction management teams are not required to distribute RFIs to each individual. The project team is notified instantaneously upon that RFI being answered, allowing for increased efficiency, less delays, and immediate decision making.

The advanced information technologies that have arisen over the years have truly redefined the way certain tasks are completed. With the use of AutoCAD, BIM, and other building modeling software, the tedious time consuming tasks of drafting and sketching have been nearly absolved. One item to note is the precision and/or accuracy and experience of the person using such software. One person surveyed mentioned that drafters and those who used to hand sketch shop drawings and plans were meticulous in their precision. Those drafters had intimate knowledge of a building's design and interconnectivity. Based on this individual's experience, he stated that "These days people creating shop drawings and plans are skilled in running those difficult to use programs and lack intimate knowledge of that which they are designing." He added that, "When those drawings were hand drawn, they were only sketched once and were rarely changed; with drawings today, it's difficult to find a set that hasn't gone through a complete overhaul."

The adoption of these advanced information technologies has proven to be beneficial and cost efficient, although there are a few industry factors that hinder the adoption of the construction industry's innovations that are critical to analyze (Toole 1998). Among the leading hindering factors is that cyclical sales could increase the squeeze felt from high fixed costs and low profit margins on total contract value, which, in turn, increase the risk of high capitalization costs. It is important to note that today's surge in information technologies should not compromise the skill and expertise of the staff that run a particular project. It is without any doubt that a project will experience changes in design; what is not acceptable is that those changes are caused by individuals who are unfit to produce such drawings. The technologies available to project professionals and project teams should in no way hinder the quality of the work. The technologies are present to allow for efficient delivery, accuracy and immediate access to available materials. Companies that use technology of this sort will find that the costs will quickly be outweighed by the benefits. Companies will discover that the efficiency developed through the implementation of the information technology will allow them to increase their profitability and, ultimately, lower the potential for construction delays and undocumented issues that contractors wish to avoid at any cost. The rapid movement from CAD to BIM by professional architects, engineers and construction management has shown that the design and construction industries are willing to make the necessary changes in order to keep up with the technological advances in information technology.

### **Concluding Remarks**

This paper presented survey results that aimed to identify the perception of the advanced

technologies and their effects from the construction professionals' perspective in the construction industry. A project team will discover new emerging techniques and methods to accomplish tasks in a more cost and time efficient manner. These discoveries are what continue to drive all industries to be more competitive and become more valuable. Specific to the construction industry, the information technology now available in the field at the project teams' expense is potentially an industry changing technology. Integration of items like the iPad, personal mini computers, and the vast array of software available to enhance management and design aspects are quickly becoming a common appearance on the construction site. The analysis results showed that these technologies for both coordination and communication in the field help them increase productivity and quality of the work process, which ultimately increase profitability and lower the potential delay and undocumented issues.

### **References**

1. C.H. Nam and C.B. Tatum (1992). Strategies for technology push: lessons from construction innovations, Construction Engineering and Management
2. Chitkara, K. K. (1998). Construction project management: Planning, scheduling and controlling, McGraw-Hill, New Delhi.
3. Emmitt, S. and Gorse, C. 2003, Construction Communication, Blackwell Publishing Ltd.
4. Higgin, G., and Jessop, N. (1965). Communications in the building industry: The report of a pilot study, Tavistock Publications, London.
5. T.M. Toole, (1998), Uncertainty and homebuilders' adoption of technological innovations, Journal of Construction Engineering and Management.

## **Increasing the Success of Lower Division Undergraduate Students through the Use of Common Teaching Tools**

Thomas Korman, Hal Johnston, and Kay Gore  
California Polytechnic State University, San Luis Obispo

### **Abstract**

This paper describes the development and use of common teaching tool, the Construction Industry Simulation (COINS), at Hartnell College community college and in the lower division undergraduate level at Cal Poly State University, San Luis Obispo designed to increase the success of community college transfer students and lower division undergraduate students. A partnership built through the use COINS seeks to educate civil and construction engineering students at the lower division and to introduce students to core engineering fundamentals that form a basis for the knowledge on which they can build in upper division courses and at the same time increase interest and excitement about engineering by incorporating project-based learning early in the curriculum. The benefits for students include better preparation of students, as demonstrated by increasing deeper understanding of project controls and constructability issues, for upper division coursework by implementing project planning and control systems engineering design and implementation, realize an increase of 25% in the retention of students who currently transfer from engineering to other non-engineering majors prior to commencing upper division coursework, and increasing the number of transfer students to civil and construction engineering programs at 4-year institutions. This paper describes the proposed collaboration and work between Cal Poly and Hartnell College community college to utilize common teaching tools and increase the success of lower division undergraduate students and community college transfer students.

### **Introduction and Background**

California Polytechnic State University, San Luis Obispo (CPSLO) is one of the three most selective public universities in California and one of the least diverse, yet the faculty still struggle with developing appropriate instructional methods and content to engage students and prepare them in the civil and construction engineering industries. This struggle results from the desire to involve students in authentic activities that teach how to develop constructible designs while retaining the delivery of core engineering fundamentals. Implementing more engaging, authentic learning activities would increase the retention of engineering students who switch majors because instruction does not link theory to practice and would attract and retain a more diverse student population in the engineering majors. Research and the demands of the industry and the current global environment compel diversity<sup>8, 19, 23, 41</sup>, thus it is imperative that CPSLO increase diversity in its engineering departments while preparing graduates to enter the workforce with the skills necessary to make immediate contributions. Further, industry reports that students' limited preparation often delays their making contributions to integration, collaboration, productivity, and accuracy, all of which are necessary in the engineering and construction industries. Project-based learning, combined with simulations and multidisciplinary learning opportunities, not only significantly enhances the ability of students to successfully enter the

modern work environment and to respond effectively to the rapid evolution of knowledge and the ongoing iteration of problems in complex systems<sup>36</sup>, but such an instructional approach also fosters the learning and participation of non-traditional and minority engineering students<sup>14, 15, 29, 31</sup>. However, based on the experience of the civil and construction engineering (CCE) faculty at CPSLO and feedback from their Industrial Advisory Board (IAB), a knowledge and skills gap exists in the CCE curriculum. This negatively impacts students' preparation as well as the retention and the ability to increase diversity.

While multidisciplinary project-based learning has been advocated in engineering for a number of years, the initiation of the Accreditation Board for Engineering and Technology, Engineering Criteria 2000 (ABET 2000), and its call for a required multidisciplinary experience stimulated increased interest in developing courses in this area. Still more recently, an increased number of papers advocating multidisciplinary project-based curricula have appeared at conferences and in journals<sup>34, 40, 42</sup>. It has become clear that project-based learning is addressing a need in the preparation of engineers that was not previously satisfied by standard curricula<sup>32, 34, 40</sup>.

Dialogue with the construction management Industry Advisory Board (IAB) revealed the following important issues and obstacles our students experience upon entering industry. First, students often have not encountered large-scale team design projects and, therefore, have to learn how to work in such an environment. Thus, on the job, they must gain experience in the process, develop a technical specialization to support their project role, and build their ability to collaborate on and contribute to multidisciplinary projects. Secondly, we discovered that our students were not prepared to apply design and construction engineering fundamentals to real world complex projects, specifically utilizing project controls to monitor and evaluate an active project.

In addition to the educational deficiencies noted in our curriculum, CCE curricula generally do not present an integrated approach to engineering education that includes practical applications of theoretical knowledge incorporating constructability issues. Students often master the course and laboratory work associated with courses in the curriculum, but they do not gain a comprehensive engineering experience that requires them to synthesize what they have learned in their curriculum and extend their knowledge through independent learning that reaches outside their field of study, specifically in the topics of constructability. This is further observed at community colleges where students do not have the opportunity of being immersed in a large-scale engineering academic environment of a four-year institution and frequently lose interest in pursuing further education or an engineering career.

This educational gap is systematic among engineering universities. Figure 1 illustrates how design engineers frequently receive limited feedback regarding the constructability of their design once a project has entered the construction phase and how construction engineers receive limited feedback regarding the progress of their project. This stems from the educational gap that exists between design and construction engineering curricula, which fail to address constructability issues and lack educational tools and methods for students to test and validate project control theory.

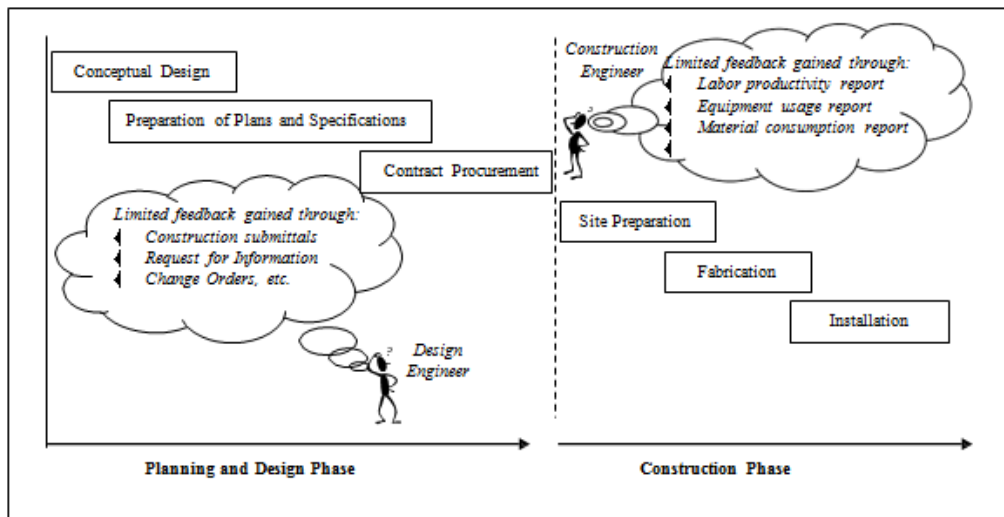

Figure 1. Limited feedback received for design and construction engineers.

Traditionally, students have not acquired these skills at CPSLO. In fact, our experience and research indicates that while many universities and community colleges offer lower division courses that teach students about project control theory, they are not able to provide an educational experience where students can practice these skills. Therefore, in an effort to produce a project-based learning experience, the CPSLO faculty have been developing COINS—Construction Industry Simulation—to reinforce several key learning objectives and to provide a valuable experience for students to work on projects that require the application and synthesis of project controls and monitoring knowledge. Through the use of COINS, students will be placed in a virtual environment to replicate, as nearly as possible, the working environment they will encounter after graduation. Students will be exposed to exercises that are significantly different from typical homework assignments in conventional courses. COINS requires students to work collaboratively and use effective communication skills. Based on our review of the literature, we expect that COINS will engage students unlike any other teaching intervention as there are currently no PBL solutions using simulations to enable students to conceptualize the demands of scheduling multiple projects with multiple resources. Other engineering simulations, such as Messner’s Virtual Construction Simulator, simulate building a specific project, focusing on very specific job areas<sup>33</sup>. COINS, on the other hand, is conceptual in nature, actively involving students in the scheduling of multiple projects and allocating multiple resources concurrently while enabling them to see the relevance in the real world of what they are learning. Finally, we anticipate that COINS will become a model for other civil and construction engineering programs who wish to enhance their compliance with the ABET 2000 requirements and foster the success of a greater number of students.

### Construction Industry Simulation (COINS)

COINS originated from a vision for enhancing the CCE curriculum articulated by Professors Hal Johnston and Jim Boland, Emeritus Faculty at CPSLO. The original version of COINS, known as Building Industry Game (BIG), was a simulation focused on the commercial building sector

of the construction industry. BIG had a built-in estimating and scheduling simulation and some accounting, which students used to emulate managing a commercial building contractor's role. The origins of BIG began with Glenn Sears, Professor Emeritus, of the University of New Mexico. Professors Johnston and Borland were granted permission from Professor Sears to write, modify, convert BIG to C++. Their idea was to transform BIG into a larger integrated construction industry simulation that incorporated more sectors of the construction industry in order to create a robust simulation tool for students to apply project control fundamentals in a virtual environment. The name Construction Industry Simulation (COINS) incorporates this vision. Using BIG as a template, COINS is in the final stages of being developed into a web-based simulation written with a JAVA front-end and using a PostgreSQL database. This version of COINS is designed to enhance learning in the CCE curriculum<sup>17, 43</sup> and addresses learning objectives from the following bodies of knowledge: Project Planning, Project Procurement, Schedule Control, and Cost Control<sup>1, 38</sup>. As they were being developed, CPSLO has used parts of COINS in its lower division CCE curriculum in limited applications, such as introducing a topic before the lecture and to complement labs, but has never formally assessed it as a teaching intervention or implemented the completed version. The lack of formal evaluation of COINS' effectiveness and the lack of materials to enable faculty to successfully and efficiently implement the program are obstacles to large-scale implementation of COINS.

### Using COINS as a Teaching Intervention

Using COINS, students will learn the basis for modeling the basic project controls for a project and then will be able to test and validate their model by receiving feedback once the model is initiated in the simulator. Students will model their design with inputs, control mechanisms, and resources. Using COINS, modeling the design will provide students with the experience to define appropriate project control measures and to select resources and inputs. Figure 2 illustrates how the selection of construction methods and operations are governed by: (1) the inputs from the design process—project plans/model, design specifications, and materials specified—, and (2) the construction phase applied resources—personnel/labor, equipment, and materials. Controls on the process include schedule, cost, and quality. Using COINS students will be led through a process which parallels a real world experience for the design of a project control system.

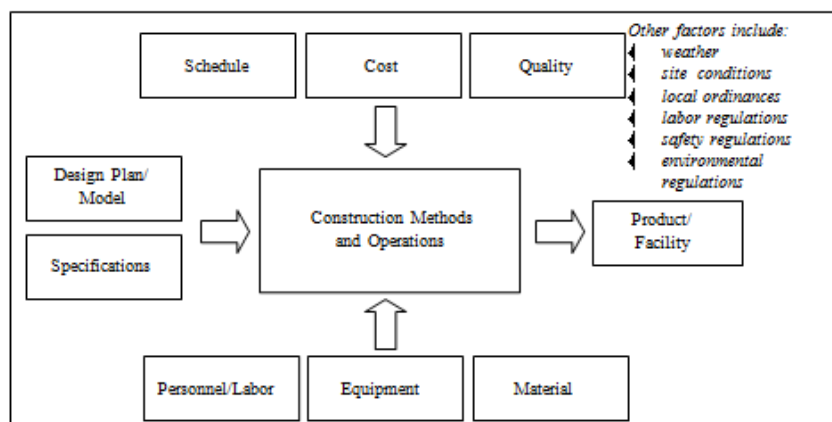



Figure 2. Construction methods and operations control model.

### **Project Goals, Objectives, and Implementation Plan**

While we have identified that lower-division students often find it difficult to see how the concepts that they learned in their freshman and sophomore years are applicable in the real world, this same disconnect is even more profound in college students who have not been immersed in the large-scale engineering academic environment of a four-year institution. Therefore, to address this problem and to research the impact of COINS on minority students, we have developed plans to collaborate with Hartnell College (HC), a Hispanic Serving Institution (Title V) community college located 100 miles to the north of CPSLO, in Salinas, California, operating in an agricultural and suburban setting.

Although, HC has a well-established 2-year Associates Degree program in engineering, according to their Institutional Researcher, currently only about 10-15% of the engineering students from HC transfer to universities within the California State University (CSU) or University of California (UC) system to complete their bachelor's degrees. The selection of HC was also based our desire to increase articulation for undergraduate students from community colleges to four-year institutions. At the Hartnell Center for Sustainable Design and Construction (HCSDC) (<http://www.hartnell.edu/csc/HCSDC/>) a similar lower-division course is offered as the course currently at CPSLO, and contains the similar learning objectives that COINS addresses. Therefore, HC is an integral partner in the development of a lower division instructor's module for all engineering majors so that COINS can be effectively adopted in both two- and four-year institutions of higher education and effectively employed with non-traditional engineering students.

### **Pilot Stage Development**

In the Pilot Stage of the development of the instructor's materials, which will occur during the first quarter of the project, CPSLO faculty will work with HC faculty to train them on COINS and its application as well as to explore successful implementation strategies and also potential problems and their solutions. For each body of knowledge and each phase incorporated into COINS, the team from CPSLO and HC will identify corresponding electronic instructor's materials and assist in their development. This will include training manuals, implementation strategies, suggestions for student assessment, demonstration videos, and electronic training curricula. Using Adobe Captivate and desktop publishing tools, we will produce e-learning components that can be delivered online. Materials will be developed to assist instructors throughout civil and construction engineering curriculum to adopt and use the COINS successfully. During the third quarter of the Pilot Stage, CPSLO and HC faculty will then co-teach labs where COINS is implemented at CPSLO in order to pilot the instructor's module. The subsequent stages will evaluate and refine the implementation and use of COINS and the instructor's module for pilot at HC in Year 1 where CPSLO and HC faculty will co-teach the initial pilot at HC.

Beginning in Year 2, a virtual community of practice, using an online forum application, will be created to enable instructors implementing COINS to share effective practices, obtain assistance to solve problems, and, throughout the project, provide feedback to improve and refine the instructor's module and enhance student learning.

### Evaluation of the Impact of COINS on Student Learning

The lower division COINS curriculum is designed to introduce students to core engineering fundamentals that form a basis for the knowledge on which they can build in upper division courses and at the same time increase interest and excitement about engineering and its applications by incorporating project-based learning early in the curriculum. Most engineering majors take an introductory engineering course that consists of at least one lecture and one lab experience that focuses on the engineering fundamentals for project controls and project tracking. We propose to evaluate the impact on student learning by incorporating COINS into the lab portion of the introductory engineering course.

By embedding the use of COINS in introductory courses, we anticipate that the research will show that core engineering fundamentals that students need in order to be successful in subsequent courses are reinforced. In a typical introductory course, fundamentals are often introduced without students being able to understand how these concepts can and will be applied in practice. Many students lose interest early on in their engineering education due to this fact. By having COINS embedded in introductory courses concurrently while students are learning core engineering fundamentals, we will assess if students are able to understand the applicability immediately and if this approach will help students to synthesize material that is introduced in other required courses and which must be considered in real world project designs.

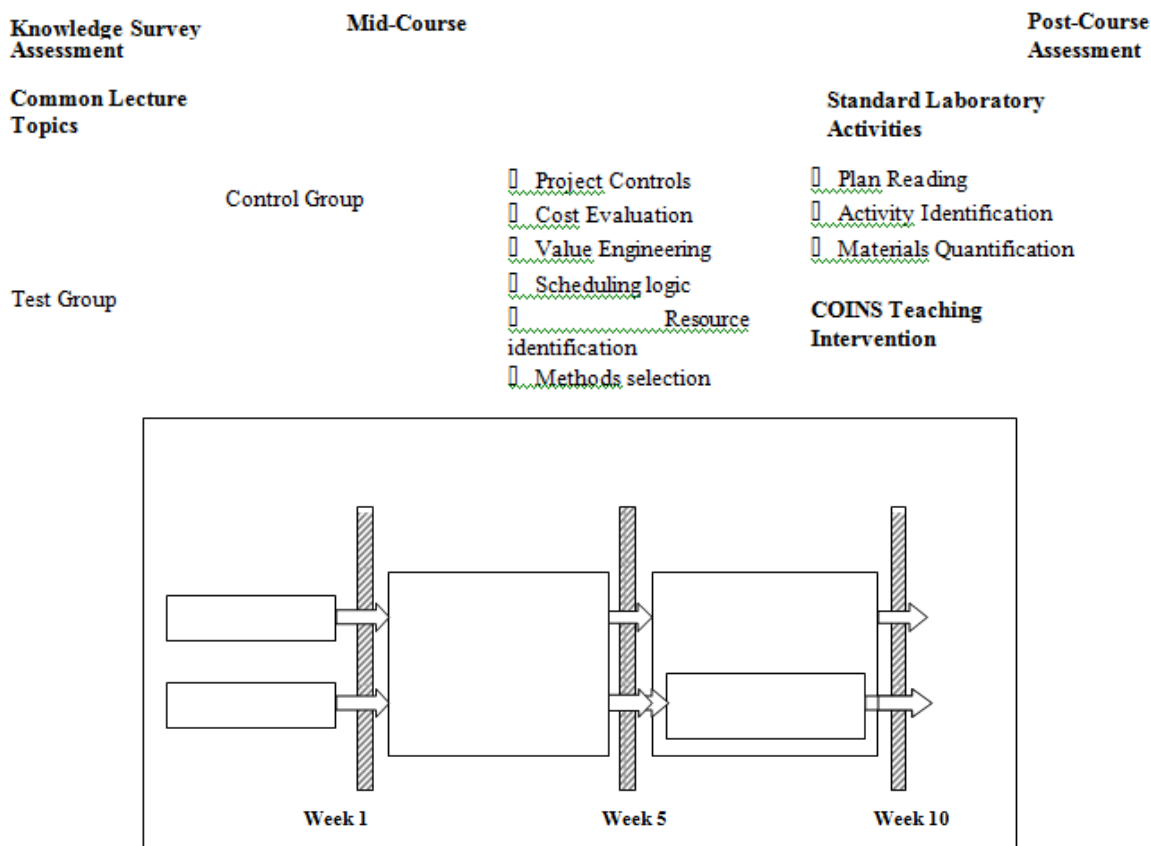

Figure 3. Plan to assess COINS effects on student learning.

## Project Outcomes

The lower division COINS curriculum was developed to reinforce the engineering concepts of project controls and to provide students with more flexibility in determining project controls versus constraining them to analyze tradeoffs which are limited at the lower division level. This approach allows students to acquire project controls selection skills in the introductory engineering courses as well as to draw upon and reinforce material that has been taught in previous courses. Therefore, in order to further develop the project-based learning approach at CPSLO and to institutionalize project-based learning in the undergraduate engineering curriculum, we are proposing to assess the impact of COINS on student learning and to strengthen the implementation of COINS by developing a lower division COINS instructor's module for use in four-year universities and community colleges. This module will prepare faculty to successfully implement COINS in order to enhance student learning, attract minority and non-traditional students to engineering, increase retention, and stimulate interest by providing real-world examples that better prepare students for upper division curriculum and for the challenges that they will face on the job.

The ultimate goal of this proposal is aimed at enhancing civil and construction engineering curricula, using an innovative learning approach that combines simulation and project-based learning in order to better prepare students to meet the ABET 2000 requirements.

## Bibliography

1. Aaron, S., Crocket, J., Morrish, D., Basualdo, C., Kovithavongs, T., Mielke, S., et al. Assessment of Exam Performance After Change to Problem-based Learning. Differential Effects by Question Type. *Teaching and Learning in Medicine*. 1998 Vol. 10, No. 2, pp.86-91.
2. Albanese, M.A., and Mitchell, S. Problem-based Learning: A Review of Literature on Its Outcomes and Implementation Issues. *Academic Medicine*, 1993, Vol., 68, pp.52- 81.
3. Bailey, R., and Z. Szabo, "Assessing Engineering Design Process Knowledge," *International Journal of Engineering Education*, Vol.22, No. 3, 2006, pp. 508-518.
4. Bransford, J.D., A.L. Brown, and R.R. Cocking, *How People Learn: Brain, Mind, Experience, and School*, Expanded ed., Washington, D.C.: National Academy Press, 2000.
5. Bradshaw, G., "Multimedia Textbooks and Student Learning," *Merlot Journal of Online Teaching and Learning*, Vol. 1, No. 2. Available at [http://jolt.merlot.org/vol11\\_no2\\_bradshaw.htm](http://jolt.merlot.org/vol11_no2_bradshaw.htm)
6. Brereton, M.F., D.M. Cannon, A. Mabogunje, and L.J. Leifer, "Collaboration in Team Designs: How Social Interaction Shapes the Product," *Analyzing Design Activity*, Chichester, U.K.; New York, NY. Wiley, 1996, pp 319-341.
7. Cleary, D.B. and Jahan, K. (2001). "Revising a Civil and Environmental Engineering Capstone Design Course," *Proceedings of the 2001 ASEE Annual Conference and Exposition*.
8. Chang, M. J., Denson, N., Saenz, V., & Misa, K. (2006). The educational benefits of sustaining cross-racial interaction among undergraduates. *The Journal of Higher Education*, 77(3), 430-455.
9. Chi, M.T.H., R. Glaser, and M.J. Fair, *The Nature of Expertise*, Hillsdale, N.J.: L. Erlbaum Associates, 1988.
10. Chi, M.T.H., *Two Approaches to the Study of Experts' Characteristics*, "The Cambridge Handbook of Expertise and Expert Performance, Cambridge, U.K.: Cambridge University Press, 2006, pp.21-30.
11. Cross, N., and A. Clayburn Cross, "Expertise in Engineering Design," *Research in Engineering Design*, Vol. 10, No. 3, 1998, pp.141-149.
12. Ericsson, K.A., and H.A. Simon, *Protocol Analysis. Verbal Reports as Data*, Cambridge, MA: MIT Press, 1993.
13. Fiegel, Gregg, and DeNatel, Jay, "Collaborating with Local Practitioners to Lead to a Capstone Civil Engineering Design Course," *Proceedings of the 2010 ASEE Annual Conference and Exposition*.
14. Fromm, E. (2003). *The Changing Engineering Educational Paradigm*. *Journal of Engineering Education*, 92(2), 113-121.
15. Froyd, J.E. & Ohland, M.W. (2005), *Integrated engineering curricula*, *Journal of Engineering Education*, Jan 2005, pp. 147-164.
16. Gijbels, D., Dochy, F., Van den Bossche, P., and Segers, M. *Effects of Problem-Based Learning: A Meta-*

- Analysis From the Angle of Assessment. *Review of Educational Research*, 2005, Vol. 75, No. 1, pp. 27-61.
17. Gransberg, D.D., Quantifying the Impact of Peer Evaluations on Student Team
  18. Project Grading. *International Journal of Construction Education and Research* ,2010, Vol. 6, pp.3-17.
  19. Gurin, P., Dey, E. L., Hurtado, S., & Gurin, G. (2002). Diversity and higher education: Theory and impact on educational outcomes. *Harvard Educational Review*, 72(3), 330–366.
  20. Hall, M.I. Motivational Strategies for Enhancing Teamwork. Proceedings, 34<sup>th</sup> Annual Conference, Associated Schools of Construction, Portland, Maine, 1998, pp. 26-29.
  21. Hanna, A.S. and Sullivan, K.T. (2005). "Bridging the Gap between Academics and Practice: A Capstone Experience," *Journal of Professional Issues in Engineering Education and Practice*, ASCE, Vol. 131, Issue 1, pp. 59-62.
  22. Hauck, Allan J. and Jackson, Barbara J., (2005). Design and Implementation of an Integrated Construction, Proceedings of the 41st Annual Conference of the Associate Schools of Construction.
  23. Herring, C. (2009). Does diversity pay?: Race, gender, and the business case for diversity, *American Sociological Review*, 74(2), 208-224.
  24. Holley, P.W., and C. Dagg, "Development of Expanded Multidisciplinary Collaborative Experiences across and Design Curricula", *International Journal of Construction Education and Research*, 2006, Yol.2, pp. 91-111.
  25. Jain, V.K., and D.K. Sobek II, "Linking Design Process to Customer Satisfaction Through Virtual Design of Experiments," *Research in Engineering Design*, Vol. 17, No. 2, 2006, pp. 59-71.
  26. Kanter, R.M. Collaborative Advantage: The Art of Alliances. *Harvard Business Review*, Vol. 4, 1994, pp 96-108.
  27. Kezar, A. Redesigning for Collaboration within Higher Education Institutions: An Exploration into the Development Process, *Review in Higher Education*, 2005, Vol. 46, pp. 831-860.
  28. Kilgore , D., C.J. Atman, K, Yasuhara, T.J. Barker, and A.E. Morozov, "Considering Context: A Study of First-Year Engineering Students," *Journal of Engineering Education*, Vol. 96, No. 4, 2007.
  29. Kramer-Koehler P., Tooney N., and Beke, D. (1995) The Use of Learning Style Innovations to Improve Retention. Retrieved from <http://fairway.ecn.purdue.edu/asee/fie95/4a2/4a22/4a22.htm>
  30. Lejk, M., M., Peer Assessment of Contributions to a Group Project: A / Comparison of Holistic and Category-based Approaches. *Assessment and Evaluation in Higher Education*, 2001, Vol. 26, pp.61-72.
  31. Mills, J. E., Ayre, M. E., & Gill, J. (2012). Gender inclusive curriculum in engineering and construction management: Final report 2012. Australian Learning and Teaching Council. Retrieved from [www.olt.gov.au/system/files/resources/CG8\\_696\\_Mills\\_Report\\_2012.pdf](http://www.olt.gov.au/system/files/resources/CG8_696_Mills_Report_2012.pdf).
  32. Mergendoller, J.R., Maxwell, N., & Bellisimo, Y. (2007). The effectiveness of problem based instruction: A Comparative Study of Instructional Methods and Student Characteristics. *Interdisciplinary Journal of Problem-based Learning*, 1(2), 49-69.
  33. Nikolic, D., Messner, J.I., Lee, S., and Anumba, C. (2010) The Virtual Construction Simulator - development of an educational simulation game. Proceedings of the International Conference on Computing in Civil and Building 2010, Nottingham, UK.
  34. Oakley, B.A., Hanna, D.M., Kuzmyn, Z. (2007). "Best Practices Involving Teamwork in the Classroom: Results from a Survey of 6435 Engineering Student Respondents," *IEEE Transactions on Education*, 50(3).
  35. O'Brien, W., Soibelman, L., and Elvin, G. Collaborative Design Processes; An V Active-and Reflective-Learning Course in Multidisciplinary Collaboration. *Journal of Construction Education*, 2003, Vol. B, pp. 78-93.
  36. Prince, M. J. and Felder, R. M., 2006. Inductive Teaching and Learning Methods: Definitions, Comparisons, and Research Bases. *Journal of Engineering Education*, 95(2), 123-138.
  37. Ryan, R.C., Increased Benefits from Using Online Class Components. *Encyclopedia of Distance Learning*. Hershey, PA: Idea Group Reference, 2005, pp. 1 064-1 068.
  38. Ryan, R.C., "Use of an E-text as a Primary Course Resource," *International Journal of Construction Education and Research*, No.4, 2008, pp.97-114.
  39. Scardamalia, M., and C. Bereiter, "Chapter 2: Literate Expertise," *Toward a General Theory of Expertise*, Cambridge, U.K.; New York, NY: Cambridge University Press, 1991, pp. 172-194.
  40. Strobel, J. & van Barneveld, A. (2008) "When is PBL More Effective? A Meta-synthesis of Meta-analyses Comparing PBL to Conventional Classrooms," *Interdisciplinary Journal of Problem-based Learning*, 3(1), 44-58.
  41. Terenzini, P. T., Cabrera, A. F., Colbeck, C. L., Bjorklund, S. A., & Parente, J. M. (2001). Racial and ethnic diversity in the classroom: Does it promote student learning? *The Journal of Higher Education*, 72(5), 509–531.
  42. United Nations Educational, Scientific and Cultural Organization (UNESCO). (2011). *The Third Research*

Symposium on PBL, Coventry University, UK, November 28-29, 2011.

43. Vogel, J., Vogel, D. S., Cannon-Bowers, J., Bowers, C. A., Muse, K., & Wright, M. (2006). Computer gaming and interactive simulations for learning: A meta-analysis. *Journal of Educational Computing Research*, 34, 229-243.
44. Walker, A. & Leary, H. (2009). "A Problem Based Learning Meta Analysis: Differences Across Problem Types, Implementation Types, Disciplines, and Assessment Levels," *Interdisciplinary Journal of Problem-based Learning*, 3(1).
45. Wilkerson, L. and Gijsselaers, W.H. (Eds.), *New Directions for Teaching and Learning: Bringing Problem-based Learning to Higher Education: Theory and Practice*, 1996, Vol. 68, San Francisco. Jossey-Bass.

## **Integration of State-of-the-Art Low Cost Components into Embedded and Digital Systems Design Courses**

Kurtis Kredon II and Dale Word  
California State University, Chico

### **Abstract**

Engineering programs often seek to integrate hands on learning opportunities to provide students with practical application of theoretical lecture material and to prepare them for future endeavors. However, providing these opportunities often requires a significant resource investment by the university, the student body, or both. This paper presents the integration of state-of-the-art low cost components into a sequence of embedded and digital systems design courses so as to maximize the learning opportunities provided to students for the resources invested. The resources required, both time and monetary, are minimized in several ways. Low cost, but flexible and current, components are selected, which minimizes costs to the university or student. The investment is further leveraged by using the components in multiple courses throughout the curriculum and allowing students to maintain possession of the components for independent learning and capstone projects. Integrating the components across multiple courses also simplifies managing replacement parts, if desired. Judicious selection of components and projects can also minimize institutional resource requirements, such as test equipment. Since a common set of components and tools are used throughout the curriculum, student progress can be streamlined in later courses by skipping introductory material and the mechanics of the tools already covered in previous classes. The consistent use of components and tools allows for a better use of course time and for an overall increase in the material presented to students. To illustrate this process, this paper presents the use of state-of-the-art low cost components in the laboratory assignments of a sequence of embedded and digital systems design courses. Representative components are presented, showing how a flexible and cost effective kit of components is built over several courses. Furthermore, the relation between the components and the methods used to support student learning over a broad range of both practical and theoretical topics are presented. Finally, alternative component selections are presented for institutions with a specific focus or specialization.

### **Introduction**

Engineering programs often desire a strong hands-on component to apply theoretical knowledge obtained in lecture settings and to foster student aptitudes in practical skills. Laboratories or design projects represent the most common method to achieve hands-on experience. However, providing for student success through hands-on assignments requires significant investment from the faculty, students, support staff, and programs. These investments have become harder to implement as funding for higher education has declined and student costs have increased.

In an attempt to decrease the required investment of resources and leverage it for maximum effect, we have integrated state-of-the-art low cost components into the embedded and digital systems design courses at California State University, Chico. We extend the value of the components by selecting those that have multiple uses in many topics, courses, and potential

student projects. These choices result in a selection of parts, tools, and related support infrastructure that provides a significant benefit for the resources invested.

*Fiscal Investments.* Our components provide value in several ways. First, the components themselves do not cost a significant amount of money, especially when costs are amortized over multiple courses. Second, current devices require a minimal amount of supporting infrastructure for development, testing, and implementation. The infrastructure investment may also be reduced with the use of low cost test equipment suitable for many undergraduate projects. Lastly, the resources for the component supply chain may be reduced with the help of student organizations, which also provides valuable contact between the student population and the student organizations.

Low cost components reduce the initial investment by students or the university. Significant projects can be supported with components costing around \$100 in total, with lower priced selections certainly possible. Components at this price point may be purchased by the students during their enrollment or by the university through appropriate funds, allowing students to keep the components. Student-owned components have several advantages. Students are more likely to use the components in later projects, which can result in them pursuing projects with greater scope since they don't have to learn a new technology before starting development. Additionally, students are left with a tangible product of their education, they are able to demo their projects to employers, and they can further expand them for professional development and presentation. The university also benefits from student-owned components since resources do not need to be invested tracking university property, recording who has possession, and implementing recovery procedures when material is not returned. The component costs are also amortized by using components in multiple courses and across multiple terms. This allows students to reuse components and feel they have made a worthwhile investment in their education. Purchasing the components over time also allows students to budget their educational costs.

Judicious selection of components allows students to reduce the infrastructure tools required to develop and test for their projects. For example, many current development boards allow students to program and debug the system without a stand-alone JTAG<sup>1</sup> programmer, which greatly reduces the cost to the student and alleviates the university from supporting costly tools for student use. (JTAG is a common interface for testing and programming digital systems.) Many manufacturers provide free versions of their software development tools for student use. These tools are often limited, in project size or time scale, but most can support student projects through their undergraduate education. Many manufacturers also offer university programs, where full versions of the tools may be purchased at a reduced cost by educational institutions.

Supporting hands-on projects can also be improved by using inexpensive test equipment. Much of the test equipment that used to remain the domain of specialized labs is now available at reasonable price for students or universities. We have found that, with increasing frequency, equipment, such as digital multimeters and logic analyzers, have become inexpensive enough that many students purchase them for their own use. Universities also benefit from these price reductions since the cost to replace damaged or stolen public equipment is reduced. The

component supply chain may also provide a benefit to the student population, especially the student organizations associated with the program. For example, the IEEE student chapter at our university manages a parts inventory for both the specific parts used in classes as well as an assortment of common parts students may use for independent or capstone projects. A similar involvement by a student organization has several benefits. First, it provides the student organization with frequent contact with students, making them familiar to the student population, providing many opportunities for student service and leadership skill development, and facilitating recruiting opportunities. This is particularly beneficial when interacting with freshmen, who then have a personal contact with upper classmen. The student organization may also profit from the management of the components by selling individual components at a marginal overhead. By buying in bulk, the student organization may sell the parts at a profit, but still less expensive than if the student had to purchase the single component and pay taxes and shipping. Students also benefit by being able to purchase replacement parts in a timely manner and quickly continue work on their course assignments or independent projects.

*Temporal Resources.* The benefits of these components are not entirely monetary. Use of consistent and planned components also provides many curricular benefits by allowing students and faculty to spend time on additional material. By using consistent components, and by implication consistent toolsets, faculty do not need to repeatedly spend course or laboratory time presenting how to use the tools and students do not need to continually read technical documents for new tools. If the curriculum allows for a reduced set of tools because of the consolidated component selection, then the students only need to learn a select set of tools. Relatedly, the toolsets and equipment may be introduced in a planned manner so that students only learn the aspects appropriate for a particular course. In early courses the basic tool usage is provided, which may allow students to perform rudimentary development and testing. Later courses may extend the toolset with the use of advanced testing, debugging, or alternative implementation capabilities, all with a small investment per course.

A graduated introduction and consistent use of tools and components also allows students to develop a mastery of the technology. Students graduating from the program would be more comfortable moving quickly into industry and becoming immediately effective. Similarly, consistent components enables students to develop a mastery of the architectures and technologies in use and, with the support of a solid theoretical background, prepares them to leverage their knowledge to use related technologies. The remainder of this paper presents our guidelines on component selection, along with an example of the components used in our program, and explains how the use of these components supports our curriculum. We close with a brief discussion of alternative components for programs whose curriculum may require a different approach than the examples provided.

### **Component Selection Guidelines and Examples**

With an understanding of our motivation, we now present the high-level characteristics desired from the components. These include traits desired of all components as well general component properties or technologies. We also include a concrete example through the component selection used in our program.



*Desired Characteristics.* The following traits are desirable for low cost components that maximize student learning.

*Low cost development.* Beyond components that themselves have low cost, component selection also influences the cost to develop and implement systems using the components. Device programmers and software toolsets are the two most significant issues related to development by students. A wide variety of low cost components are available, but their use often requires access to a device programmer. For microcontroller-based systems this often requires a JTAG or similar programmer, which can easily cost hundreds of dollars. JTAG programmers have multiple uses, but are extravagant for most undergraduate students, who typically use them in a limited manner. These considerations also apply to programmable logic components that may have to be programmed by removing them from a circuit and placing them in a standalone programmer. Devices which are directly programmable with simpler devices or with an inexpensive cable are preferred.

Development may also be simplified by the integration of stand-alone development boards. These boards often include the basic infrastructure, such as voltage regulation, interface conversion, and basic user input and output, required to support an advanced technology. Using these boards allows students to quickly begin development without implementing the underlying infrastructure. These boards may also be integrated as a component within larger projects. Development software also represents a challenge for maintaining low-cost since many professional development toolsets cost thousands of dollars. Selecting components whose manufacturer or partner vendor provides low cost development tools are greatly desired. Fortunately, some development toolsets are available to students with a time-limited or size-limited restriction. This allows students to install the software on their own machines so development may occur at home instead of requiring students to work only in the laboratory. We have found that size-limited restrictions are preferred to time-limited so students deal less frequently with licensing complications. In our experience, the size limitations have not been a significant issue for the scale of projects covered in undergraduate programs.

Our program has minimized cost by selecting development boards that use USB cables for programming and whose manufacturer provides free, limited versions of software toolsets to students. Component boards using USB for programming typically utilize a USB to JTAG converter to support indirect device programming. Our students use free, student versions of software, including the Diamond<sup>2</sup> design suite from Lattice Semiconductor for digital design and Embedded Workbench for ARM<sup>3</sup> toolsuite from IAR Systems for embedded software and microcontroller development.

*Flexible and expandable components.* Supporting multiple courses, and potentially capstone projects, with a coherent selection of components requires those components provide great flexibility. Two primary ways components prove flexible is to provide a wide variety of interfaces or functionality and to provide as much direct I/O as possible. Selecting components that provide more functionality than any one class requires, but in total support the requirements of all classes, can greatly expand the usefulness of the components. The clearest example is the selection of microcontroller boards. Many inexpensive microcontroller boards are available at comparable costs, but some offer a wider variety of functionality and higher

performance. I/O pins also represent an interesting challenge for component selection. Directly using advanced integrated circuit components today requires surface mount board production and assembly, so this approach is costly to implement. Development boards are more approachable by removing the manufacturing overhead. However, development boards vary widely in their cost and I/O availability. Many inexpensive development boards provide few expandable I/O pins either because the main device on the board is limited or because the I/O is already connected to peripherals on the board. Ideally, development boards provide ample I/O directly from the component of interest. Our program has ensured flexibility by selecting boards that provide little more than the basic infrastructure for the main component and connect all other I/O to header pins for student use. However, there are basic peripherals we find advantageous on all boards, such as a limited number of buttons for user input and LEDs for basic output.

*Microcontroller.* The core of many embedded and digital system design courses is a microcontroller or microprocessor, so careful selection of this component can be of vital importance. To maximize usefulness, the microcontroller should support multiple courses and a wide variety of potential projects. Desirable traits include a large selection of available I/O pins, but also an ample selection of peripheral components and advanced system functionality. However, the microcontroller selected should provide support for rapid student development, so students may quickly apply the theory from class and implement course projects. Basic microcontrollers have historically provided basic peripherals, such as simple timers, interrupt capabilities, and general purpose I/O. State-of-the-art microcontrollers also provide many advanced functions, including multiple and various serial bus interfaces, direct memory access controllers, advanced timers, external memory buses, LCD controllers, and more at a marginally higher cost than basic microcontrollers. Selecting these state-of-the-art microcontrollers enables their use in basic and advanced course as well as capstone projects.

Advanced microcontrollers would have limited value if students were unable to achieve their project goals due to the time necessary to learn and configure the peripherals. Thus, complementing the complexity of an advanced microcontroller with suitable development support is critical. Libraries present a viable solution to limit the complexity presented to the students, but care must be taken to balance complexity that encourages learning with complexity that encourages frustration. The libraries should also ease system development without hiding the system aspects students are expected to learn. Faculty can optimize the level of complexity by creating the libraries, but this requires a significant time investment. Libraries provided by the manufacturer, if available, reduce load on faculty, but leave little room for controlling complexity.

Our program uses several Discovery boards<sup>4,5,6</sup> available from STMicroelectronics (ST), which are based around ARM Cortex M3 or M4 microcontrollers. The microcontrollers used on these boards provide a wide variety of peripheral components, often in duplicates, and offer advanced configuration and control for senior-level courses and capstone projects. The Discovery series includes a wide variety of boards, with most below \$15. Additionally, ST provides a Standard Peripheral Library that allows students to quickly develop applications for the microcontroller and easily transition between the various families of microcontrollers sold by ST.

*Programmable logic.* Advanced digital design courses often utilize hardware description languages and programmable logic in some manner, so selecting an adaptable device will allow students to greatly reuse their components. Copious advanced programmable logic devices exist, but many of them cost significant amounts and are difficult to work with directly due to dense packaging. Therefore, components for undergraduate students will likely focus on development boards with small-scale components. Luckily there are several choices for programmable logic development boards at moderate cost, with a wide variety of available peripherals. Multiple technologies are presented as well, including Complex Programmable Logic Device (CPLD) and Field Programmable Gate Array (FPGA) components. Some of the latest low-cost components also include embedded hardware peripherals, which can ease implementation of some digital systems. Our program selected the MachXO2 Breakout Board<sup>7</sup> by Lattice Semiconductor due to its fairly large size, copious available I/O pins, and low relative cost.

*Development platform.* Individual components require some mechanism for interconnection and development, which we will call the development platform. While many development methods exist, care must be taken to ensure the platform supports a wide variety of projects and assignments, can be used quickly and effectively by students, and allows for quick corrections due to mistakes and redesigns. A development platform must provide a method for students to connect components with strong physical and electrical connections and, ideally, provide an overall physical support for the entire system. Common options for development platforms include specialized add-on boards, breadboards, soldering, and wire wrapping.

Specialized add-on boards, often called wings, are attractive because students can simply plug in the component and begin programming the assignment. However, add-on boards suffer from a comparatively high cost, are often very focused in functionality, and hide many learning opportunities from students. Programs that rely on add-on boards may have to purchase several per student to support all of the courses and projects the student will encounter. Additionally, since add-on boards come pre-assembled and designed to minimize interfacing issues, they do not provide students with many opportunities for designing and building their own system, experiencing signal interface issues (proper grounding, voltage levels, current capacities), or the circuit debugging that comes along with implementing a complex system.

Breadboards provide a method for quick connection of system components and are widely used in engineering programs, but have several disadvantages for larger systems. Many of the development boards available use double row header pins, making bread boards untenable. Additionally, components with a wide variety of pin diameters and connection arrangements make breadboards challenging, as pins may not fit or make poor contact. Component selection can minimize these issues, but then may limit the projects available to students. Distinct advantages of breadboards are the inherent supportive structure they provide to projects, their low cost, and ease of use.

Soldering provides a very strong physical and electrical connection between components and can accommodate parts with a wide variety of pin configurations. The most significant disadvantage of soldering is the difficulty in changing a connection, especially when

components with multiple pins are used. Given that students often make mistakes and must rework a portion of a design, soldering would induce significant overhead on course projects. Additionally, students unfamiliar with soldering techniques can easily destroy components by using excessive heat or by creating solder bridges. However, soldering is an important skill and is often required in some way for any digital system.

Wire wrapping provides a compromise between breadboards and soldering: strong electrical and physical connections in a low amount of time. With the addition of a prototyping board, wire wrapping allows students to build and support a system with only moderate effort. Changing the system requires an acceptable amount of time, which allows students to make mistakes and correct them without significant penalty. Cost, while moderate for hand tools, is relatively higher for wire wrapping than using breadboards or soldering. Our program uses prototype boards and wire wrapping as the development platform, but integrates soldering of select components so students gain this experience.

*Peripherals.* While a microcontroller and some programmable logic allow for students to develop simple systems, they are not sufficient to build more interesting projects and do not cover a wide range of course topics. External peripherals provide a method for projects to be adapted to exactly what a course requires and enable students to apply their design methodologies. Many interesting peripherals are available at moderate cost, allowing faculty to adapt and modify assignments every term to increase interest and discourage cheating. Our program integrates multiple peripherals, such as a voltage regulator, temperature sensor, LCD screen, switches, and servos.

*Example Component and Software Selection.* The components used in most of our courses are listed in Table 1 and represent an example of the software tools and components that may support embedded and digital design courses.

Table 1. Summary of example components and costs.

Hardware	
<i>Component</i>	<i>Approximate Cost</i>
Lattice MachXO2 Breakout Board	\$30
STM32F3-Discovery Board	\$11
LCD Module	\$10
Prototype Board	\$11
Wire Wrap Tool and Supplies	\$28
Passive and Discrete Components	\$20
Software	
<i>Toolset</i>	<i>Cost</i>
IAR Embedded Workbench	\$0
Lattice Diamond	\$0
<b>Total</b> (tax and shipping excluded)	\$110

## Relation to Curriculum

We now present how the use of low cost state-of-the-art components has strengthened several courses in our program, with examples of how the components are used to support student learning through project assignments.

*EECE 237 (formerly EECE 337).* The first course our undergraduate students take in this integrated sequence is a sophomore level course (EECE 237), entitled “Embedded Systems Development.” This course previously was purely focused on assembly language programming, based on the Motorola 68000 family processors. The goals in updated this course were to 1) integrate it more with the other related courses, 2) move it to a low cost, more modern platform and processor, and 3) reduce its focus on assembly language to approximately half of the course time (7 weeks), and add an introduction to embedded systems development (in C) to replace the reduced content.

In this course, students are required to purchase an ST Microelectronics STM32F3-Discovery development board for approximately \$15, which they retain at the end of the course. A free version (with a code-size limitation) of IAR Embedded Workbench for ARM, a commercial software development environment, is used to develop the embedded applications (both in assembly language and C) that are the major work product for the course. The use of an embedded, source level debugger provides an excellent environment to support student learning in this subject area. The visibility into the processor details (register contents, status registers, etc.) that this environment provides gives students an excellent intuitive understanding of execution sequences and instruction specifics, particularly in their early work in assembly language.

One of the final lab assignments for this course is for the students to create an embedded application for their board that implements a precise reaction timer. An external LCD module is connected to provide a textual display interface. The application displays a series of countdown messages on the LCD, and the user attempts to hit a button exactly at the zero point of the countdown. The application then displays the timing error in the user response, in milliseconds. This assignment brings together several key concepts from the course, requiring the students to configure an on-chip hardware timer to track time in milliseconds, program an external interface to the LCD (via an I<sup>2</sup>C connection), and use interrupt handlers to detect the button press event.

*EECE 344.* The second course taken in the sequence is a junior-level digital systems design course (EECE 344), titled “Digital Systems Design,” which centers around building a large digital system, including a microcontroller, programmable logic, and external peripherals. Due to the use of so many components in this course, it drives much of the selection of components. This is the first course in our curriculum where students design and implement a large system with multiple hardware components. As such, they develop several practical and theoretical skills through the course. An example system built by students over the semester is the controller for an electronic safe. The project consists of a microcontroller driving the overall system operation, with an external bus for peripherals. Programmable logic is used for glue logic and to implement an address decoder, which selects between display LEDs, input switches, and an LCD. A servo is used to model the door lock mechanism and a temperature sensor, through an

A/D converter on the microcontroller, detects if thieves attempt to torch the safe or freeze the electronics.

While implementing the system, students apply theory related to microcontrollers, buses, address decoding, interrupts, timers, general purpose I/O, digital design with an HDL, analog conversion, power regulation, and motors. Additionally, they develop or master several practical skills, including methodical debugging and problem solving, comprehension and generation of technical documents and schematics, prototyping (wire wrapping and soldering), effective use of logic analyzers and software debugging, and the benefits of software libraries. Previously, this class consisted of building a Motorola 68000 microprocessor-based system including memory and a limited number of small components (registers, decoders, and basic gates). Using low cost state-of-the-art components has enabled students to build much larger systems of greater complexity. The components used are similar to those in Table I.

*EECE 437.* The upper division course in our embedded systems programming sequence is EECE 437, "Real-Time Embedded Systems." This course extends students' knowledge of embedded systems development, adding the concepts associated with real-time computing and design considerations, real-time operating systems, and embedded software engineering techniques. It also exposes students to larger scale embedded development efforts, involving the use of standard and vendor supplied software libraries. In order to expose the students to the most detailed and low level view of real-time operating systems, the concept of a real-time operating system is developed from the "ground up", starting with the time based design considerations of embedded systems without a real-time operating system, then introducing the concepts of multitasking and context switching as a solution to problems that are too complex to solve with just an interrupt based implementation. As the examples used in the course become more complex, additional aspects of a real-time operating system are introduced as solutions to implementation problems. This approach gives students an intuitive understanding of the design tradeoffs, implementation details and functional goals of different aspects of real-time (and other) operating systems. This approach deepens student understanding, and prepares them to critically evaluate systems and products they will encounter in their professional careers.

There are two parallel development pathways utilized in this course. Students begin the course using an ST Microelectronics STM32F429-Discovery development board, implementing interrupt based applications and gradually moving to applications using a real-time operating system, FreeRTOS. Overlapping with the latter part of that sequence, and continuing through the end of the course is the path using Texas Instruments' Stellaris Evalbot platforms, based on an ARM Cortex M3 processor. This is a simple robotic development board with wheels, motors, contact sensors and a graphic display. The exercises with this development platform explore problems that require solutions that rely on different real-time operating systems functions and capabilities.

An example lab assignment that forces students to explore the details of interprocess communications is one in which the students implement a series of tasks, each of which has a read message queue (with a blocking read) and another message queue that it sends to. A main driver task generates a series of messages, each of which is numbered, and sends them to the

first of these tasks. That task then sends the message on to the next task, with the process repeating until the last task in the chain sends the message back to the main driver task. Students implement this message passing loop, then experiment with the effects of changing task priorities on the order of messages received by the main driver task. This experimentation typically produces results that are unexpected, causing students to go back and perform a detailed analysis of the message passing sequence and the associated task switching that occurs, greatly enhancing their understanding of the relationship between interprocess communications and task switching.

*EECE 444.* The final digital design course in the integrated sequence is “Microprocessor Systems Design,” an upper-level course that includes topics such as advanced buses, interrupt and arbitration circuits, direct memory access, and advanced processor topics. A significant advantage of using the low cost state-of-the-art components in previous courses is that this course requires very few new components (a single \$1 IC this term) due to the breadth and flexibility of functionality available in current components. Example projects that utilize the components from previous courses are a low power design contest, a signal processing application, and implementation of an arbitration circuit. The low power design project has students study energy conservation techniques such as frequency scaling, sleep modes, and clock and power gating to minimize the overall energy consumed by a system. DMA, timers, analog conversion circuits, and coprocessors are used to perform basic, real-time signal processing within a Cortex M4 microcontroller. Arbitration circuits are evaluated and compared by implementing them within programmable logic. Students also get to select a short independent project using the base components and a small collection of parts of their own selection

*Capstone Projects.* Anecdotally, we have noticed that many students continue to use their components within capstone projects. This provides several benefits for students. First, their capstone project development costs are reduced, allowing them to pursue projects with slightly more costly peripherals at the same level of investment. Reusing the parts also allows students proceed quickly in the project since they do not need to study and learn a new architecture or technology before implementing their project.

A recent example involves a student using his components to build a slot machine, where a microcontroller board performed the main system control and a CPLD interfaced to a sound generation circuit. Since the student was able to quickly begin using his components, most of his efforts could be spent on integrating proper random number generation, controlling motor timing for the reels, mechanical design and construction, and overall system integration.

### **Alternative Components**

Not all programs have similar needs or curricula, so the examples we provided may not apply. However, there are several other options available for programs that still wish to integrate state-of-the-art low cost components in a similar manner.

*Arduino and related.* There are a large number of microcontroller development kits and boards available that could potentially be used as the basis for this kind of low cost platform. Most popular among these kits is the Arduino<sup>8</sup> family of processor boards and expansion modules (“shields”), that provide a very simple to use, flexible platform for building basic embedded

systems. Another similar platform is the mbed development platform<sup>9</sup>, an ARM processor based development board that emphasizes ease of use and quick prototyping. Both of these solutions (and other similar ones) are well suited for projects, but are somewhat less desirable for use in course work. The emphasis of these simplified development platforms is on ease of use, which they accomplish by providing extensive software support libraries that abstract out much of the low level detail of the board's hardware components. In university level engineering courses, the goals are very different, often specifically focusing on the low level detail of the hardware and interfaces. This need to have access to the microcontroller hardware at its lowest level was a key factor in our process of evaluating products on which to base this effort, leading eventually to our selection of the ST Microelectronics Discovery boards.

*Soft-core and hard-core embedded processors.* A common approach for studying microprocessor or microcontroller systems is to use soft-core processors (those implemented within programmable logic resources), such as Xilinx MicroBlaze<sup>10</sup> and Altera Nios II<sup>11</sup>. Relatedly, some programmable logic devices may come with hardcore processors embedded within the programmable logic device. This has several advantages in that the programmable logic components may be reused to a greater extent, processor design and implementation may be integrated into architecture courses, and costs can be saved with the reduction of components. Our curriculum maintains the distinction between digital design and programming until advanced courses, where the two are combined. One benefit of this approach is students do not develop the mentality that programmable logic is "just another way to run C code."

*Exclusively HDL.* Another alternative selection would remove the microcontroller completely and rely all on digital design through an HDL. In this approach, the component selection may focus more on a larger or higher performance programmable logic board or add additional peripherals. Programs that introduce an HDL early in their curriculum and use it consistently throughout their digital design courses, particularly if microcontrollers or microprocessors were covered in separate courses, would find this path beneficial. However, integrating microcontrollers with programmable logic through component selection and related labs enables many additional topics, such as advanced interface design and coprocessor integration.

## **Conclusion**

Low cost state-of-the-art components provide many advantages for embedded and digital design curriculum, from low initial and support costs to the benefit of a streamlined educational infrastructure. Learning opportunities are maximized by allowing students to maintain possession of the components and by using a consistent set of tools and devices across multiple courses. Component and tool reuse allows students or the university to amortize costs over a longer period of time and enables faculty to present more topics by avoiding toolsuite and device introductory material. We have developed and improved the curriculum of our program by integrating these components and feel that many other programs could also reduce monetary and time investments while also increasing student learning, accomplishments, and success.



**Bibliography**

1. IEEE Std. 1149.1 for Test Access Port and Boundary-Scan Architecture. Accessed March 2014.  
<http://standards.ieee.org/findstds/standard/1149.1-2013.html>
2. Lattice Semiconductor. Lattice Diamond Design Software. Accessed March 2014.  
<http://latticesemi.com/Products/DesignSoftwareAndIP/FPGAandLDS/LatticeDiamond.aspx>
3. IAR Systems. IAR Embedded Workbench for ARM toolsuite. Accessed March 2014.  
<http://www.iar.com/Products/IAR-Embedded-Workbench/ARM/>
4. STMicroelectronics. STM32F3-Discovery Kit. Accessed March 2014.  
<http://www.st.com/web/en/catalog/tools/FM116/SC959/SS1532/PF254044>
5. STMicroelectronics. STM32F4-Discovery Kit. Accessed March 2014.  
<http://www.st.com/web/catalog/tools/FM116/SC959/SS1532/PF252419>
6. STMicroelectronics. STM32F429-Discovery Kit. Accessed March 2014.  
<http://www.st.com/web/catalog/tools/FM116/SC959/SS1532/PF259090>
7. Lattice Semiconductor. MachXO2 Breakout Board. Accessed March 2014.  
<http://latticesemi.com/Products/DevelopmentBoardsAndKits/MachXO2BreakoutBoard.aspx>
8. Arduino Homepage. Accessed March 2014. <http://www.arduino.cc/mbed> Homepage. Accessed March 2014.  
<https://mbed.org/>
9. Xilinx. MicroBlaze Soft Processor. Accessed March 2014. <http://www.xilinx.com/tools/microblaze.htm>
10. Altera. Nios II Embedded Processor. Accessed March 2014.  
<http://www.altera.com/devices/processor/nios2/ni2-index.html>

## **Hands, Mind and Hearts-on Design Experiences**

Samuel Landsberger, Artin Davidian, Juan Garibay, Richard Valenzuela, and Barbara Wheeler  
California State University, Los Angeles/ University of Southern California

### **Abstract**

This paper presents an innovative duet of programs called HERE and HERO to introduce students from traditionally disadvantaged backgrounds, students with disabilities, and women – groups under-represented in science and engineering - to problem-solving, social engagement, and the field of Rehabilitation Engineering. It is the author's experience that students from all backgrounds, but particularly minorities and women, find projects to help those with disabilities immediately relevant and highly engaging. The Hands-on Experiences in Rehabilitation Engineering Program (HERE) provides a stimulating, hands-on learning experience while fostering mentoring among students at different ages and levels of engineering training. The student participants – frequently from the poorest and least served communities of Los Angeles, range from 6<sup>th</sup> graders in Compton, CA to graduate students and instructors at the California State University, Los Angeles and the University of Southern California. HERE provides direct contact between students and individuals with disabilities in the context of team design projects. Projects often build upon earlier student work, with an ultimate aim of creating refined designs that students can take pride in, and that are ready for potential manufacture as products to benefit people with disabilities. A closely interwoven outreach program called HERO (HERE-Outreach) links HERE college students with grade school students in at-risk neighborhoods. The mission of HERO is to inspire youngsters, both by example and through engaging hands-on projects, to keep free from gangs and drugs, apply themselves to their current studies, and in the future to go to college and consider Rehabilitation Engineering as a potential endeavor. The focus in this paper will be upon the University-based HERE program, with the outreach described in more detail in a subsequent publication. HERE has now completed over fourteen years, evolving considerably over this period in scope, structure and support base - but remaining true to its original goals. Partners have included the California State University, Los Angeles (CSULA), a nationally recognized, leading-edge minority education institution, Rancho Los Amigos Medical Center, the Los Angeles Orthopedic Hospital, the CSULA Mobility Center and Ninos Y Padres Program, and the University of Southern California University Center of Excellence in Developmental Disabilities. One outgrowth is that CSULA College of Engineering, Computer Science and Technology has now developed several new Service Learning Courses and a new undergraduate option in Rehabilitation Engineering.

### **Summary of Program Outcomes**

#### *Student participation and growth*

More than 750 college students, primarily from minority and traditionally under-represented backgrounds, have to date participated in the HERE Program, and over 500 middle and high school students have been engaged in the HERO Outreach Program. Program staff and students, as well as faculty and staff from the Orthopedic Hospital, the UCEDD, and the University, note that students have benefited greatly from active exposure to new areas of

engineering endeavors. For many of the students, the opportunity of engaging in Rehabilitation Engineering projects to provide direct benefit to others provides perhaps the first (if not the unique) satisfactory answer to a question that seems often gnawing and persistent, yet unspoken: beyond engineering as a stable career, how will my work satisfy my urge to be of service, an engaged and contributing member of my community? The disciplines of engineering and science do require enormous commitment and hard work of students (and often their families) from any background – and that much more so from students of impoverished communities. At the same time, it may be observed that such students feel a proportionately greater sense of responsibility to their families and broader community, having experienced more deeply their own and others' hardships, and so are demanding more of themselves than mere economic success – as attractive and important as that goal may be.



Student surveys administered to the middle and high school HERO participants have documented gains in student awareness of disability issues, engineering practice, and opportunities for university study. Students have grasped through direct experience that service can be both means and end for both learning and creative endeavors. Students have also learned simple yet valuable hands-on design and construction skills, and have benefited from nitty-gritty teamwork experiences and skill building. These

valuable design skills, not learned elsewhere in the curriculum, include working directly with clients, uncovering customer needs, distilling problem specifications from vague problem descriptions, developing alternative creative solutions while investigating existing and prior art, interacting with clients to select among competing design solutions, implementing those solutions using the latest in Computer Aided Design technology, and then obtaining client feedback to evaluate the efficacy of those designs, along with a cost analysis accounting for very real-world constraints.

*Students shine (sometimes unexpectedly)!* The programs have provided students in the secondary schools with weaker academic backgrounds - but some hands-on design and building aptitude - the chance to shine before their peers and teachers. To the surprise of some teachers, the hands-on projects also served to bring into the picture the active participation of some of the children's fathers, who so often are under-represented on the educational scene.

For the college students and the HERO Program staff, there has been tremendous growth from the mentoring roles students have played in bringing the hands-on engineering program to middle and high schools in the heart of some of the poorest areas of Los Angeles. In a parallel manner as found in the K-12 classrooms, Program staff have observed that undergraduate engineering and kinesiology students that may not be star students on more traditional academic turf – but may have, for example, a remarkable rapport with the youngsters, or strong hands-on skills - shine in their role as patient and engaged teacher-mentors. Indeed, the same students that may not have rated their own academic skills very highly often discover in the

process of teaching that their academic studies have enriched them far more than they initially thought!

*Experiences make a difference!* Just as the K-12 students receiving mentorship benefit from the HERO Outreach, the college participants have grown through their experiences in ways that prove helpful in their later applications for employment and graduate studies. An important outcome of the HERE/HERO programs has been the success of several alumni in finding good engineering jobs and graduate school placement after graduation, and sometimes even while still in school. These post-baccalaureate positions range from HERE alumni entering Biomedical Engineering Graduate Programs at UCLA, to positions of responsibility at high-tech engineering firms including Boeing Aerospace and Edison. As a result of the student final presentations to the Engineering Department and Industrial Sponsors at Cal. State L.A. a few years back, a manufacturer adopted the project of commercial manufacture of the BeachCruiser all-terrain wheelchair. One team member was immediately recruited by that firm to help refine the chair for manufacture. His position there has continued, with responsibilities expanded to include oversight of some joint Mexico-USA manufacturing projects.

Students have commented repeatedly on the difference that their involvement made in applying successfully for internships and full-time employment. Indeed, several have noted that the HERE Program provided them with their single most impressive experience to share during job interviews. The students often credit success to their participation in independent, hands-on projects that provide a concrete product to a client, complete with test results. This seems in equal parts due to the nobility of their cause, the independence and initiative they have shown in pursuing the projects and participating in outreach, and the valuable hands-on design/build skills they have acquired in the context of working closely with real clients and reckoning with real-world constraints.

*Innovative student designs.* The projects have attracted wide-ranging interest from children with disabilities and their families, the university community, and Medical Center researchers and clinical service providers. Some of these full-scale designs see regular, active service in the Dept. of Kinesiology Mobility Center, a rehabilitation exercise laboratory. This very active lab is popular with both students and clients with disabilities and is closely allied with the HERE program. It is an educational facility offering regular exercise training to disabled individuals both on campus and from the surrounding community, while providing exercise science students with hands-on training in exercises for the elderly and disabled population. Indeed, in the past year, a close relationship with CSULA College of Health and Human Services' Kinesiology Department has been forged that has allowed the HERE program access to more varied clients and their needs for improved exercise machines. Kinesiology faculty and student exercise trainers also provide regular input on project requirements and are key in reviewing project progress. Kinesiology students have worked with engineering students to define and evaluate projects, and this multidisciplinary team approach has been very exciting for everyone involved.

*Student prizes and public recognition.* Students engaged in the HERE program have won numerous prizes for their design work, and been publicly recognized in the media for their innovative design efforts. The prizes bring tremendous pride to the student participants, of course, but also to the College and other participating staff and organizations - and consequently

place the whole endeavor in an attractive light. *La Opinion*, a leading Spanish language newspaper, and other local media have featured student work on these projects to help the disabled, and the internationally syndicated *Despierta America!* television program produced by Univision, Inc. provided coverage of one project, the Beach Cruiser that was viewed by audiences from Guatemala to Vermont. A number of relatives of the CSULA students, many of whom are recent immigrants from Central and Latin America, were able to see on television the work and pride of these students.

The attention is helpful in enabling Rehabilitation Engineering to compete more effectively for mainstream student interest. Traditional student endeavors – often geared to local and national well-established competitions, such as the SAE race car or Mini-Baja vehicle, or a robotics competition – tend to attract student interest even before entering college. Students without personal experience of disability (either in themselves or a loved one) must often overcome some natural reluctance to enter this environment, although it is a wonderful and fruitful environment to apply engineering to meet vital human needs.

A Low Vision System, incorporating a camera system and laptop computer in a briefcase, captured 2<sup>nd</sup> place in a regional IEEE student competition. A new prosthetic hand design won first prize in a RESNA student design competition, while an innovative Beach Cruiser wheelchair garnered third prize at a leading manufacturing convention, WESTEC - beating out the previous year's first and second place entries and making it Cal State LA's first winning entry. Further, faculty associated with the program have earned Service Learning Awards for their work in support of these projects, and the Dept. of Kinesiology garnered an award from a local Senior Center, as well as from a County Government Services Office, for its efforts to better the lives of its clients. The relationship began with a HERE project to involve engineering students in problem-solving activities with seniors from the Los Angeles East Valley Multi-Purpose Senior Center.

*New service learning courses and a rehabilitation engineering option in engineering.* Faculty associated with the HERE program have created new Service Learning courses incorporating Rehabilitation Engineering as a means to both study and apply new skills in Engineering Design and rehabilitation exercise. These courses, ranging from freshman – graduate level, have been offered to both Engineering and Kinesiology students, and are well received. A new Option in Rehabilitation Engineering has been created for students wishing to specialize further at the undergraduate engineering level.

*Participation of university and medical professionals.* A further important outcome of the programs is that numerous university teaching, administrative and support staff, along with medical professionals, together with 10 secondary school teachers and five school principals, have been introduced to the field of rehabilitation engineering. They have been stimulated by the excitement, engagement and dedication shown by the students, and the creative potential they have demonstrated year after year in conceiving of new designs and in some cases bringing them to constructive fruition. Faculty Civil and Electrical Engineering – as well as within the PI's home departments of Mechanical Engineering and Kinesiology – have shown spontaneous interest in involvement, and this has stimulated multi-disciplinary teamwork among previously

unlikely collaborators, including both various Engineering disciplines together with Adapted Physical Education, Rehabilitation Exercise, and Special Education.

*Outcome summary.* From the perspectives of all involved, especially the energetic student participants, the HERE and HERO programs have been very successful and have proved to be as exciting as they are challenging for both students and staff. Both the HERE Program staff and student participants are eager to continue the work. Multi-year participation in the HERE program benefits student alumni as they deepen their knowledge, hone design skills and gain teaching experience as they mentor the incoming students. Students learn best from their peers, so the new students entering the curriculum also benefit greatly through this mentoring.

*Rehabilitation engineering education program origins and evolution.* The National Institute on Disability and Rehabilitation Research, U.S. Dept. of Education, originally supported the creation of the HERE&HERO Programs in 1998 in conjunction with a Rehabilitation Engineering Research Center on Children with Orthopedic Disabilities at the Rancho Los Amigos Rehabilitation Engineering Program. The programs evolved from an early effort called Assistive Device Venture that was created in 1995 by the first author, then Technical Director of the Rancho Rehabilitation Engineering Program, to involve youth from Rancho Los Amigos Medical Center injured in gang-related violence in a Rehabilitation Engineering Design Experience. The concept was that some of these young men and women might be inspired by a constructive, real-world challenge to develop technology for someone with even greater physical challenges than themselves. Assistive Design Venture comprised a team of six students recruited from a violence-prevention program called Teens-on-Target who met each week at Rehab. Engineering to create a shock-absorbing wheelchair laptop computer mount and transport case for a High School student with severe muscular impairment. The proud students presented this highly successful work at the 1996 Cal. State Northridge International Conference “Technology and Persons with Disabilities”. Several of the young participants have remained involved with the Rehabilitation Engineering Program over the past decade. The program has since evolved to comprise a synergistic partnership between the California State University, Los Angeles, the Orthopedic Hospital, Los Angeles, and the USC University Center of Excellence in Developmental Disabilities (USC - UCEDD).

## **HERE & HERO Program Description**

### *Aims:*

- To spark interest in Rehabilitation Engineering (R.E.) and provide a rewarding, hands-on learning experience for university students from traditionally disadvantaged backgrounds.
- To introduce Middle and High School students, particularly in poorer communities, to the exciting field of Rehabilitation Engineering.

## **Student Participants**

The core participants at the undergraduate level have been Cal State University L.A. students recruited from the Mechanical Engineering Senior Design Course, new Rehabilitation Engineering classes at the senior and graduate level, senior Kinesiology students from a newly-created Rehabilitation Machines class, and freshmen and sophomore engineering students enrolled in a required *Introduction to Design* course. USC students from a Rehabilitation Engineering Course in past years have also been enthusiastic participants. Past years have included several students from the “Math Engineering Program” (MEP) Freshman Orientation

Course designed particularly to address the needs of students from traditionally underserved communities. In each year of the program, the scope and quality of the projects has continued to improve. Some projects in active use in the Kinesiology Mobility Center, and others are slated for installation at a new Accessible Playground at the Orthopedic Medical Center. In addition to the undergraduate participants, several hundred middle- and high- school students have participated in the HERO Outreach program described below.

*Educational strategy.* The HERE program is a problem-based curriculum to introduce students to the fundamentals of R.E., in the context of direct exposure to human problems. The thesis driving this effort is that students' analytical and creative energies are evoked and focused as they work together in design teams to study and address the needs of individuals with orthopedic disabilities including muscular weakness, spinal cord injury or limb deficiencies. Student growth is enhanced by mentoring and teamwork activities that are built in as integral elements of the program. At the University site, HERE partners with both the College of Engineering, Computer Science and Technology, and the College of Health and Human Services. The HHS Kinesiology Department at CSULA is host of an innovative laboratory for rehabilitation exercises with significant outreach to the disabled community. HERE also collaborates with the highly successful Math and Engineering Program (MEP). The MEP is based upon the principles of community building and collaborative learning. It fosters peer interaction between its participants and provides enrichment opportunities so that the desire to learn and apply oneself is both stimulated and nurtured through consistent high expectations, mentoring and peer support. In providing mentoring to the engineering students and support for its outreach effort to students in at-risk communities, HERE has collaborated with community-based organizations. These include also Senior Centers in the surrounding community.

### **Program Structure**

The program comprises four basic elements:

1. Overview & Fundamentals: lectures, reading and site-visits giving direct exposure to the needs of the clients, along with accomplishments and techniques of Rehabilitation Engineering.
2. Hands-on Creative Design: team-based work to help a specific client with a disability. Laboratory instruction is provided in support of the design work, in accord with the large number of freshmen students and the program aim to accommodate students from other disciplines. Final designs and results are presented to a public audience.
3. Paid Fellowships in Orthopedic Hospital's Rehabilitation Engineering R&D Laboratory.
4. HERO Outreach: bring R. E. exposure to middle and high school students in at-risk areas.

The elements are now described in brief detail, with further elaboration of the synergistic components, particularly the HERO Outreach, in subsequent sections of the paper.

*Overview & fundamentals.* Lectures introduce students to a wide perspective of the field of Rehabilitation Engineering: various types of disabilities, some challenges faced by those with a disability, and tools and techniques that have been devised to address these challenges. Lectures are interspersed with guest speakers and field trips to industry. These typically include wheelchair design companies, Prosthetic & Orthotic hardware manufacturers, the UCEDD, and Orthopedic and Shriners Hospitals, and a P&O training school (Cal. State Dominguez Hills)

where students may meet peers involved with hands-on P&O work and see state-of-the-art artificial limbs and braces.

Students visit clinical rehabilitation programs at nearby hospitals, including OH and Children's Hospital clinics serving numerous survivors of gang violence who now live with spinal cord injury. Exposure to this dimension of rehabilitation work, and the diverse population it serves, brings the field of R.E. and its application very close to home for many of the HERE participants. It is a powerful motivator for future design work. Bringing cultural relevance to the engineering curriculum is a major challenge faced by educators in stimulating interest among disadvantaged minorities, many of whom may find traditional engineering and science applications to be from a world apart.

*Hands-on Creative Design.* Teams of student engineers form virtual companies with real budgets to tackle creative design projects. The projects may relate to work in progress at the Orthopedic Hospital Rehabilitation Engineering Program, e.g., developing a hydraulic-powered finger for a hand. They may also support sports activities, such as improved wheelchairs and accessory equipment for tennis, basketball, hockey and baseball, or the needs of a Disabled Scuba Training Program. Past work has also involved collaboration with teachers at a special preschool for children with disabilities. Projects may target needs of a specific client, such as means of adapting a piano foot pedal for a player without use of her feet. Students themselves may also propose the design projects, e.g. mobility aids or other devices to assist a relative or friend with a disability. One such project is the Portable Low Vision System to help a severely visually impaired student in the class read the blackboard.

In support of the intensive design activity, students participate in laboratory work from the get-go that introduces them to practical, hands-on skills. These include basic design organization and process, brainstorming of ideas, teamwork skills, conflict resolution, drawing by hand and computer, and machining exercises utilizing the lathe, drill press, band saw and milling machine. Exercises progress from creation of a pencil holder from a block of wood, to designing, building and mathematically modeling a flow Venturi. This is a device illustrating the counter-intuitive yet very useful Bernoulli's Principle that pressure drops where flow velocity increases. The teams' work is presented at a Design Exhibition at Cal State L.A. to which the clients, public and press are invited. The work is, as appropriate, also submitted to RESNA and other conferences, and to student design competitions, such as WESTEC and IEEE, where the students have competed successfully.

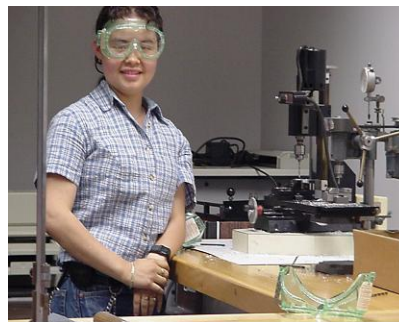

*Paid Fellowships in a Rehabilitation Engineering R&D Laboratory.* To provide follow-through to the HERE curriculum and experience in a professional environment, a professional, a ten-week summer paid Training Fellowship at either Rancho Los Amigos, the Orthopedic Hospital Rehabilitation Engineering Program or the CSULA HERE Laboratory has offered to qualified graduates of the program who have demonstrated interest, motivation and commitment. Students either continue with refinement of their HERE projects or proceed with supervised independent research and development work. They also engage in the HERO outreach program to youths.



This provides an opportunity for those with genuine interest in Rehabilitation Engineering to continue to gain valuable experience throughout their college careers, and help others along the path.

*HERO: Outreach to K-12 students.* The HERE Outreach Program (also called HERO) brings together local Middle School and High School students with budding young Cal State engineers to engage in hands-on engineering activities. Mentors engage as many as 60 to 80 students per academic year with challenging and skill building projects. The activities are coordinated with the classroom teacher's ongoing curriculum for maximum benefit to the class. The engineering students serve as mentors to the younger students, introducing them to creative activities. The exercises build on the students' classroom work while introducing them to an exciting application for engineering skills in the field of Rehabilitation.

#### **Client Contact**

The HERE program begins with, focuses upon, and ends with student-user/client contact. Students are encouraged to enter the world of their clients with a disability. This raises awareness of the unique issues and challenges faced by these special folks. Early client contact also provides a clear focus for the design problem and greatly enhances each student's motivation, knowing that she or he is solving *her own* client's problem. Further, the client is able to give the student better feedback on the usefulness of the device and is more eager to test it if he or she is a partner in defining the need. Students first meet their clients with disabilities in order to begin to define the design problem. The relationship formed is then continued throughout the project in a consistent way, through the conceptual, preliminary, final design and prototype evaluation phases. In the short time period of any student's participation, it is most realistic to focus on a solution to a particular client's needs, rather than attempting to define generic needs of an entire group of individuals with a defined disability.

The value of client input was borne out very clearly in recent projects, including the rehab exercise devices and the beach chair. Past years' hockey chair and low vision projects also demonstrated very effectively the value of team collaboration with clients, with users actually participating as members of the design teams. Integral to the forming of a student-client relationship and the evolution and evaluation of new designs is the presence of a clinical therapist. The therapist also provides advice and feedback during the refinement of student designs into commercial-ready products.

#### **Freshman – Graduate: Design Courses emphasizing Service Learning in Rehabilitation Engineering**

A new Service Learning version of a required Mechanical Engineering Design Course at CSULA, ME 103, has been developed that incorporates Rehabilitation Engineering as a means to both study and apply new skills in Engineering Design. At the senior undergraduate level, an introductory rehabilitation engineering design class has been created, and these valuable design skills, not learned elsewhere in the curriculum, include: working directly with clients, uncovering customer needs, distilling problem specifications from vague problem descriptions, developing alternative creative solutions while investigating existing and prior art, interacting with clients to select among competing design solutions, implementing those solutions using the latest in Computer Aided Design technology, and then obtaining client feedback to evaluate the efficacy of those designs, along with a cost analysis. Although students worked long hours beyond the call of

duty to complete both their designs and hands-on construction projects, they have unanimously rated the course with the highest course evaluations the PI, Dr. Landsberger, has received in over 20 years of teaching. A new *Rehabilitation Machines* Service Learning course has also been created in Kinesiology, exposing students in that discipline to creative design for the first time (with projects often in collaboration with engineering students). Finally, a Service Learning modification has been made to the Introductory Engineering course that offers students the chance to participate in HERO Outreach and mentor K-12 youth in surrounding schools. Many take advantage of this option and, though wary at first, end up greatly enjoying the experience, and often volunteering for extra sessions.

As illustrated below, students have completed surprisingly innovative and sophisticated designs for several projects distilled from direct interaction with clients and Kinesiology students in the Rehabilitation Exercise Laboratory, including: standing-assist frames for wheelchair users to independently stand and work upright, an active/passive cycle trainer, an improved incline-plane leg exercise machine, a partial weight-bearing assist for parallel bar use, and an improved hand-or-foot-powered exercycle for safe and independent access.

### **HERE Partner Programs and Rehabilitation Institutions**

The academic home for the HERE program is at the California State University, Los Angeles (CSULA). Vital partners in the effort to bring true experiences of Rehabilitation Engineering to our students have also been the Rancho Los Amigos Rehabilitation Engineering Program, the Orthopedic Hospital, the U.S.C. UCEDD and the East Los Angeles Community College. The Child Amputee Prosthetics Project of the Shriners Hospital, Los Angeles, has also contributed valuable projects and experiences for the students. The affiliated clinics, rehabilitation, education and research centers breathe vitality into the program, and enable students to experience firsthand a professional practice dimension, direct contact with clients, and excellence in scholarly, experimental engineering and scientific pursuits. Students enter realms they have never imagined, and interact with professionals that unstintingly share their expertise and enthusiasm. Nothing could contribute more to the growth of the students than the opportunity to enter these realms and explore – with a real project of their own in hand!

A close relationship exists with the CSULA College of Health and Human Services' Kinesiology Department, with whom one author holds a joint appointment. This department is host to the *Mobility Center*, an educational facility offering regular exercise training to disabled individuals both on campus and from the surrounding community, while providing exercise science students with hands-on training in exercises for the elderly and disabled population. This has allowed the HERE program access to more varied clients and their needs for improved exercise machines. Kinesiology faculty and student exercise trainers also provide regular input on project requirements and are key in reviewing project progress. Kinesiology students have worked with engineering students to define and evaluate projects, and this multidisciplinary team approach has been very exciting for everyone involved.

### **Student Internships and Summer Fellowships in Rehabilitation Engineering Programs**

One of the most enjoyable and inspirational aspects of conducting research and development in the field of Rehabilitation Engineering is the active participation of students. Rancho Los Amigos and the Orthopedic Hospital have long traditions of student involvement in research. The students enjoy and are highly motivated by the opportunity to apply their academic training to real-world problems in order to benefit those in need. It provides them with

valuable internship experience and professional discipline. For the research effort, the students bring in a breath of fresh air, gracing even the longest-standing projects with new energy and a “why not...” viewpoint unencumbered by expertise. Their computer skills often outdistance those of their mentors. Students who have demonstrated initiative, motivation and commitment during the academic year have often received Training Fellowships to spend ten weeks in the summer working in the Rehabilitation Engineering Program. In a number of instances, the summer students have chosen Rehabilitation Engineering Fellowship projects over better-paying summer employment elsewhere. Summer Fellows often have the opportunity to continue the projects they commenced during the school year, and correct problems noted in initial prototype evaluations and to get more feedback on their designs from further patient evaluations. Others become involved in ongoing research projects at the Rehab. Eng. Program. Each of the patient evaluation sessions was conducted in a clinic facility where the students saw the broad potential for R.E. design. Students also gained a sense of accomplishment and an appreciation for the importance of their work. Students also frequently volunteer to participate in the HERO Outreach Program to middle and high school students, described below.

Some examples of student summer work in a professional Rehabilitation Engineering Program include:

- Continued design studies and development work on the innovative BeachCruiser Wheelchair providing independent access to beach and surf.
- Design and construction of a Mobile Arm Support fatigue test fixture in support of one of the Rehabilitation Engineering Program research projects.
- Students also worked directly with a support staff member at CSULA to develop a comfortable, lightweight, variable-height chair for her daughter, who has Spina Bifida. The chair requires no lifting force to operate, and has been a tremendous success in the home. In fact, the infant child seat that the chair incorporates wore down quickly to the plastic beneath the durable fabric, and required renewal within one year.
- Design, construction and implementation of a prosthetic hand laboratory evaluation test.
- Power amplification systems for prostheses.
- Mechanical test fixtures to evaluate glove and foam materials.
- A counter for prosthetic prehensor use outcome measurement.
- Carbon fiber brace measurements and material property evaluations.
- A portable low-vision system for visually impaired students.
- Prosthetic socket pressure transducer validation studies.

Students also participate in special machining projects designed to hone their skills, and be better prepared to help the next HERE freshmen class with their projects. Students also participated in valuable teamwork-skill development workshops. These included Team Building, Communications, and Conflict Resolution workshops led by staff experienced with these valuable and perhaps under-utilized exercises.

### **Student Presentations, Program Publicity and Dissemination**

Students have demonstrated their projects in clinics at the Orthopedic Hospital, Rancho Los Amigos and Shriners Hospital with both clients and clinicians in attendance. The proud designers have also made presentations at special Design Exhibitions at Cal. State L.A., and at

National and International Conferences devoted to Rehabilitation and Assistive Technology. These include the Rehabilitation and Assistive Technology Society of North America (RESNA) and International Society of Prosthetics and Orthotics (ISPO) conferences, along with International Society of Electrical and Electronics Engineering (IEEE) Biomedical Engineering conferences. Students have also presented their work at the WESTEC National Conference featuring state-of-the-art developments and products related to Industrial Technology.



At these numerous professional meetings students enjoy the exposure to R.E. professionals and the opportunity to see the current state of the art in Rehabilitation Engineering and other Biomedical-related fields. In addition, student papers have been submitted by HERE students and accepted for conference presentation. Models of the student work have been repeatedly received with great praise and interest. Conference attendees are without fail impressed by the quality of workmanship, ingenuity of design, and the dedication and enthusiasm achieved by students in the HERE Program. One of the student teams won a Paralyzed Veteran's Association (PVA) Student Design Competition Award from RESNA at the RESNA '2000 Conference in Orlando, Florida, another an IEEE prize, and a 3<sup>rd</sup> a WESTEC award for originality of design.

Following the summer session, the students give a presentation attended by the hospital medical director and representatives of many departments. Through this, along with many previous presentations, the students not only disseminate their work and the program, but also gain valuable experience in organizing a talk, preparing audio-visual aids and speaking before a professional group. The students have been extremely enthusiastic about the program and the positive attention they receive.

The HERO Outreach itself is an important dissemination tool, in addition to its direct educational service in exposing youngsters to the fields of Engineering and Assistive Technology.

The press, both local, metropolitan and beyond, have demonstrated keen interest in our program. Closest to home, the CSULA student newspaper has faithfully covered the yearly presentations with extensive articles and photographs. The Orthopedic Hospital Foundation Report, and CSULA University Report for alumni have likewise featured the work. At a metropolitan level, *La Opinion*, a leading Spanish language newspaper, met extensively with HERE program staff and students and subsequently published a comprehensive cover-page article that was helpful in drawing community interest to our work. The internationally-viewed *Despierta America!* television program by Univision featured the Beach Cruiser navigating the Santa Monica beach, bringing a moment of international fame to many proud HERE students and their families.

Finally, Program Staff regularly have participated in National Conferences and Workshops aimed at increasing the participation of under-represented groups, including minorities,

women, and people with disabilities, in disability-related projects, training and research. These include several sponsored by the National Institute on Disability and Rehabilitation Research.

### Sampling of Innovative HERE Projects

Senior Engineering students engaged in the HERE program proudly display their innovative Projects annually in Exhibitions at the California State University, Los Angeles. The projects receive tremendous interest from CSULA faculty, students, and several faculty visitors from neighboring Universities, and engineers and scientists from regional engineering and manufacturing companies. Some of these full-scale designs, described in more depth in this section, are on active duty in the School of Kinesiology and Nutritional Sciences' Rehabilitation Exercise Laboratory, called the *Mobility Center*, as well as the CSULA *Ninos Y Padres* pre-school for children with disabilities. The very active Mobility Center is popular with both students and clients with disabilities and is closely allied with the HERE program. It is an educational facility offering regular exercise training to disabled individuals both on campus and from the surrounding community, while providing exercise science students with hands-on training in exercises for the elderly and disabled population. The Mobility Center provides the HERE program access to clients of all ages and from many walks of life, and projects focus upon their needs for improved exercise machines. Kinesiology faculty and student exercise trainers also provide regular input on project requirements and are key in reviewing project progress. Kinesiology students work closely with engineering students to define and evaluate projects.

All HERE projects begin and evolve based upon a relationship formed with a particular client with disability. The multidisciplinary, client-focused team approach has been inspiring for everyone involved, not least of whom are the staff and professors. We now describe a sampling of the innovative HERE projects completed by students. Some have potential for commercial development.



*Shane's Inspiration* Accessible Playground near the Los Angeles Zoo in Griffith Park.

a) **Fun with Exercise: The Merry Go Round:** A new generation of HERE-“Wheeee” –Go! dynamic playground activities are being designed for

1. fun
2. healthful exercise
3. social engagement and collaboration between young folks of all ages with and without disabilities.



With the motto: “bringing play to exercise, and exercise to play!” the wheelchair-accessible hand-pedal powered Merry Go Round has been designed for installation in the new Orthopedic Medical Center Accessible Playground.

The design process leading to the new Merry Go Round is illustrated in the accompanying figures, and embodies the HERO – HERE – CLINIC progression process. First, several ideas for innovative play structures were initially conceived by students participating in the HERO Outreach Program at the Orthopedic Hospital Medical Magnet High School, located in the inner city region of Los Angeles. A small competition was held, judged by hospital staff, to determine a winning idea to propel forward. Second, the winning design – an accessible, arm-powered merry go round, was refined by senior engineering design students and several conceptual designs for this innovation were presented to a client focus group including children, parents, a parent advocate and therapists convened by the Orthopedic Hospital staff. Third, on the basis of that feedback, followed by a helpful conference with a manufacturer of Playground Structures, a final design was selected best satisfying the desires of the client group and meeting the constraints of cost and size dictated by the Playground Planning. Fourth, the students then studied and applied the necessary safety criteria, finalized the design, created computer drawings and engineering analyses, and then constructed a working prototype.

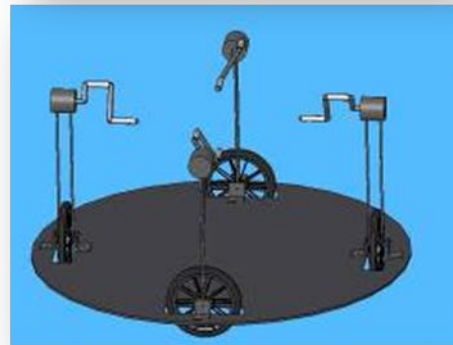

The prototype was tested in both the laboratory and with children, including some with disabilities from an Adaptive Physical Education Program at CSULA, and others at the Orthopedic Hospital. Test results were analyzed and incorporated into final design improvements – and the students made separate presentations to Hospital Staff, Researchers, and their fellow Engineering students and faculty. A donation was solicited by the Orthopedic Hospital Foundation to create a playground-ready version that was developed and installed one year later, with inspection, input and final approval from professional playground inspectors.

The Merry Go Round is the first design of what is hoped will be a whole generation of accessible, fun playground exercise technologies. Several new and visionary play designs have been created by both High School and CSULA HERO/HERE students from Kinesiology and Engineering, and will be developed in collaboration with Playground Manufacturers in future program cycles.



b) **The BeachCruiser** is an innovative self-propelled wheelchair for sandy terrain designed to dismantle and fit in the trunk of a car, to be assembled and deployed by a user with paraplegia with minimal assistance in 20 minutes. It has been developed over several design cycles by HERE Program students. This project has even attracted a modest commercial interest, benefiting from manufacturing refinements suggested by a local Engineering and Production Company with long ties to CSULA. A recent cycle of the project

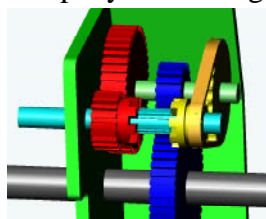

focused on developing a lightweight, rugged, low-cost transmission to allow for forward, neutral and reverse operation. This provides increased maneuverability while providing a safer vehicle for beach access. Additional new features include a throttle control placed on the handlebars to allow the operator to keep both hands on the handlebars for better control of the vehicle and a swivel-base seat to allow for 90° rotation in either direction to facilitate entry and exit from the Beach Cruiser. The seat is lightweight and comfortable and allows for the rider to utilize his or her own cushion. The student team worked closely with its client, who has paraplegia. The design has been successfully field tested, and won Third Place at a National Student Design Competition sponsored by WESTEC, one of the nation's largest

Manufacturing Engineering Conferences.



c) **Mechanized Therapy Bed:** Individuals with disabilities using the CSULA Mobility Center exercise facilities, along with their exercise trainers, benefit greatly from a mechanized therapy/exercise platform developed by an ambitious team of HERE engineers. The need for the adjustable platform was apparent since the trainers assisting the patients using the existing stationary bed suffered from lumbar strains due to frequent lifting of patients from a lowered stationary bed (at wheelchair seat level) onto a higher one while progressing from one exercise to another.



The HERE student engineering team faced the challenge head-on and through many visits to the exercise facility conducted surveys of the doctors, trainers and the users. The team finally arrived at an elegantly simple solution, the Mechanized Therapy Bed (MTB). It is an ergonomic, user-friendly solution for raising an individual from 18.5 inches (wheelchair seat height) to a desired (35 inches) height set by the facility director. The team accomplished this task via free-hand sketches, stress analysis, and complete working drawings. Additional considerations included manufacturability and production material costs, with a primary concern for safety. The students are proud that the MTB is currently stationed at the Mobility Center Exercise facility and both trainees and trainers are very satisfied with its performance!

**d) Parallel Bar Trainer Assistant (PBTA):** Parallel bars are an extremely useful rehabilitation tool in providing walking exercise and weight bearing in a controlled environment. Nonetheless, conventional systems require at least one and preferably two trainers alongside the user, in part to safeguard against possible falls. This project was conceived as a trainer assistant device to both prevent falls and to provide a selected amount of support to the patient, easily monitored by the trainer. The goal was to create a design that might be retrofitted to off-

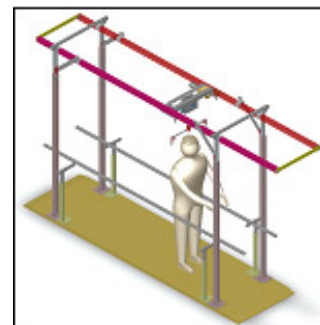

the-shelf parallel bar systems, such as found in the Mobility Center. The cost for a comparable commercially available device is approximately \$22,000, and requires a large floor space as well as a minimum of 10 feet ceiling clearance – neither available in our Center. The PBTA, by contrast, has been designed to attach to any parallel bar device and requires a ceiling height of only 8 feet. The cost of manufacturing the student-designed PBTA was about \$700 (naturally, this excludes most of the labor fees in addition to marketing/insurance/overhead costs!). The PBTA, the product of an intensive design effort on the part of its student creators, has been delivered to Cal State LA's Mobility Center and is a success, being used with some frequency by patients with stroke and other mobility impairments.



**e) Easy Lifter Standing Frame:** A Standing Frame is a device used to assist a person in rising from a sitting position to a standing pose. A common problem reported by clients using the existing Standing Frame at Cal State LA's Mobility Center is the high forces exerted on their knees as they are being lifted and/or lowered. Users of these machines

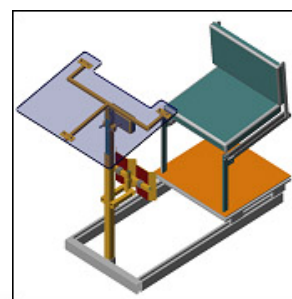

have also complained that the speed and control of lifting/lowering mechanism is inconsistent. The difficulty in accessing the device (in/out) is often great, and the sitting strap is not only uncomfortable but demeaning as well. Our students attacked this project with great enthusiasm. They interviewed the patients, therapists and doctors at the Mobility Center and listened to their complaints as well as suggestions. Their next step was to develop as many different and unique ideas as they could possibly think of,





and then gradually narrow down to a single feasible design. This group of student engineers designed and analyzed their design until the HERE mentors gave the green light for production. The students worked long and hard in manufacturing their standing frame, faced numerous difficulties but with persistence and hard work overcame all their challenges. Both manufacturing and testing of this project have been completed. The Easy Lifter appears to have addressed all the major concerns, and added some nice innovative features, including use of the seat for general mobility within the Center when not in use as a Stander.

**f) Improved mechanism geometry for a child's prosthetic hand:** Prosthetic hands for young children generally provide inadequate grip function. Addressing this deficiency, a series of hand-design HERE projects have built upon Rehabilitation Engineering Program research. One student design improves the grip of a commercially-available hand by altering the mechanism to enable grasp of large cylinders without the scissoring effect that tends to push objects out of the gripper. The new prosthetic hand design won first prize in a RESNA student design competition. A subsequent student project has created a new computer-enhanced model of the REP Easy-Feed Hand Geometry that aims to minimize the cognitive and physical demands placed upon the child using the hand.



**g) Adapted SCUBA Gear** was a project designed for a student client with paraplegia who enjoyed SCUBA diving before his paralysis. A special, easy-access wetsuit was developed and mountain-climbing harness adapted to better enable disabled people to enjoy SCUBA diving. The setup consists of a Diver Propelled Vehicle (DPV) electric propulsion unit, a custom easy-on and easy-off wetsuit, and harnesses that take the strain off of the user's upper body from use of the propulsion unit. The freedom allowed by the new gear allows the user to enjoy underwater sightseeing adventures with ease. This project has been tested and received high praise for its function and innovation.



**h) Low vision system:** One of the students in the HERE program has a low vision disability and has great difficulty reading the blackboard in class. He believed that his team might meet this challenge, and indeed, the student team devised a system that comprised a digital camcorder, a laptop computer and interface software for real-time viewing all in a compact, rugged briefcase. The design goal was to provide real-time image capture of the blackboard viewed on the laptop LCD screen, with magnification selected by the user. The client uses a joystick-controlled camera to display portions of the blackboard on an LCD screen. The system also allowed for simultaneous note taking by the student using the same laptop. Using commercially available items, the students created the design. The student with visual

impairment both helped design, and then successfully tested the new system, his team members glowing with pride. The device enabled the client to view blackboard text clearly on a screen right at the user's desk. This project, like the others, vividly demonstrated the need for a client-based development process in order to create a product that can be used by the client, and which can be further developed to serve other clients with similar disabilities. The Low Vision System was recognized by the 4th annual IEEE Biomedical Engineering Biotech Contest and won 2nd place.

**i) Adaptive Mouse** was developed for a fellow student with tetraplegia having minimal manual dexterity. The student is an artist highly skilled with computer graphics. To create his masterpieces, he requires a highly customized adaptive interface for fine control of the mouse. Using readily available materials, the students were able to develop a low-cost and elegant adaptive mouse solution that harnesses the client's dexterity and enables him to create digital artwork on the computer, as well as perform routine tasks. The mouse was built in two sections. The first section (containing the mouse and trackball) is situated on the Client's left side to enable him to navigate on the screen. The second section situated on the Client's right side is a specially designed and wired switch that performs all functions of a left-click button on PCs and a mouse button on Apple machines. Both these devices are mounted on adjustable hoses that provide variable positioning to enable the most comfortable switch placement.



**j) The BackSaver - Child's Multi-level Seating System:** Lifting and repositioning children all day is hard work – and can take its toll on teachers' and caregivers' backs! A child's seating system was developed in conjunction with the Niños y Padres Center for Disabled Children at Cal State U. LA. This device helps the child to socialize and interact with other children in a classroom. The system comprises a manual and motor-powered height-adjustable seat with adjustable inclination. It employs a rack-and-pinion drive derived from a 12V-powered boat trailer jack. The child may – without lifting - be positioned at tables of various heights alongside other children, or close to the ground to play. This project benefited from donations of seating system and marine hardware by a few vendors. Students get good practice in asking for help in every quarter, for both expertise and hardware resources!

**k) Wheelchair Hockey Guard Frame:** Wheelchair Hockey is a vigorous, high-contact sport wherein inflicting damage upon the opponent's wheelchair is an accepted mode of offensive play, similar to the roughhousing characterizing able-bodied ice hockey. Damage to the chairs' front castors occurs frequently, delaying or preventing further play. This project aimed to design and develop a strong aluminum structure that could be manufactured as a modular component for attachment to a popular hockey chair. To achieve their goal, the students collaborated with a hospital-based Wheelchair Sports Program and consulted with the Colours



wheelchair firm. A one-piece frame add-on was constructed and assembled in time for a major tournament. It can be easily and quickly removed for chair transport. It was also field tested by wheelchair hockey players. The design proved almost adequate for the high impact hits that occur in the game, and was further strengthened following early field trials. A year later, it was still intact and is fitted to the wheelchair of choice for the goalie.

**l) Garden Access Ramp:** This project was presented by one of our HERE students to the HERE staff and students. She works over the weekends with an elderly woman who was in dire need for a ramp to be built at her home. The problem was that she could not get to her back yard without going down two steep steps. This woman is 85 years of age and was unable to manage the steps. A ramp to replace the steps would allow her to enjoy her backyard again. The ramp the students built consisted of cement base and hand rails. 3 HERE students, which were all young women, took up the project and completed it at the end of spring quarter. The woman is once again able to go into her backyard independently to enjoy the garden.

**m) Water Lift with Dignity:** The Kinesiology department desired a special easy pool access machine. A HERE team of students designed and manufactured an adjustable and affordable water lift that provides a person with a disability comfortable and safe access into and out of a pool. The design employs the parallelogram concept to maintain the user in a level orientation. An inexpensive hydraulic jack serves as lifting mechanism. The final design has solved the problem of safety and stability. Most importantly, the Water Lift project increased the awareness of the group members towards the need for improved machines for aquatic assist our disabled population.



**n) A powered, arm-elevating device for a patient using mobile arm supports,** whose purpose is to enable a wider range of desktop and feeding activities. This device was designed as a contribution to ongoing research to replace an existing spring system that does not work well for many patients.

**o) A docking device for a patient using mobile arm supports.** The docking device, also in support of ongoing REP research, keeps the patient's arm in position while driving the wheelchair or reclining the wheelchair



These sample projects illustrate the types of creative group design activities that students with minimal prior training have successfully engaged in for the benefit of their peers with disabilities.

### **Future Aim: Inclusive HERO**

An aim for future work is to build upon the successful HERE/HERO model to create an educational and service-learning program tailored specifically to engage students with disabilities, at both the college and K-12 levels. The aims of this program will be to engender a positive experience of active, inclusive engagement among students with and without

disabilities, to promote positive perceptions of students with special needs by their able-bodied peers, and to enhance both groups' knowledge and appreciation for basic engineering and kinesiology principles and the field of rehabilitation engineering. Further, the program will engage students with disabilities in voluntary service learning activities, where students are empowered to help not only themselves, but also others through participation in science/mathematics/engineering mentoring and assistive technology project design activities. As mentioned above, a further vision for the future is that the HERO program will root deeply in the least advantaged communities of Los Angeles and will build strong relationships between students, mentors, and schools that begins in an Elementary school and continues without interruption with the students as they progress through Middle and High School, and eventually helps bring them to college - where the HERE program awaits to welcome them.

### **Conclusion**

Project HERE has provided disadvantaged engineering students - freshmen through senior - with meaningful and productive experiences in Rehabilitation Engineering. The HERO Outreach Project to at-risk students in Compton and at the Orthopedic Hospital Medical Magnet High School has likewise consistently proved a valuable experience for both the HERE participants and the secondary school students. Faculty at Cal. State Univ. LA from a wide range of disciplines, including Engineering, Kinesiology, Special Education and Vocational Education, are enthusiastic about the opportunities it provides for the college students. They particularly appreciate the way students became immediately involved in a practical, socially directed project - and they expect some of these students to remain committed to Rehabilitation Engineering as a life goal. Both the university and the hospital administrations have also been very pleased with this effort to involve students from the surrounding community with creative work of benefit to the society at large and surrounding community in particular. They observe that the work is stimulating to the clinical staff, and potentially beneficial to the care of its patients. Teachers from the Orthopedic Hospital Medical Magnet High School and the Ralph Bunche Middle School in Compton are ever eager for the return of HERE volunteers and staff to help spark interest and aspirations for college in their students.

The HERE students have demonstrated an exceptional commitment to their work, often laboring long hours to finish projects and voluntarily devoting weekends and holidays to the cause. The projects became an all-consuming interest for many, and the excitement of seeing a patient use their device was memorable for all involved. Summer students seemed eager for the chance to learn more and worked very hard on their projects even though some received no school credit for their summer work. The involvement of skilled violence-prevention consultants with first-hand knowledge of life with a disability seemed of benefit to the student design teams in their work and was also great help with the Outreach Program to middle school students in an at-risk community. This participation also may help bridge the gap for the students between the new area of Rehabilitation Engineering and the hard realities of everyday life on the street that is so much a part of L.A. experience.

Finally, there are tangible outcomes for the students resulting from the HERE program. Some of the student projects are already on the way to becoming commercial products, such as the Sand Cruiser beach wheelchair and potentially some of the innovative and low-cost

rehabilitation exercise machines. The experience provided by this program has also either directly enabled or assisted a number of students to find gainful employment. One of the student mentors from a preceding year directly credits his involvement with coaching the students in Computer Aided Design tools for an internship with one of the largest and most prestigious CAD software development firms, where he will be providing customer training. Another student has found gainful employment with the firm producing the Beach Chair. As mentioned, some of the HERE students have won design awards (including monetary prizes) for their projects. It is important that the HERE program can provide positive reinforcement, and even modest monetary support, for staying in school. These are very exciting developments for the students as real-world outcomes of their hard work.

## References

1. Landsberger, S., Davidian, A., & Garibay, J. Invited Presentation: A New Incubator Training and Manufacturing Model and Hands-on Rehabilitation Engineering Education for Minority and at-Risk Youth, *Capacity Building Workshop for Minority Involvement in Rehabilitation Research*, National Institute on Disabilities and Rehabilitation Research, Washington, DC, July, 2005.
2. Davidian, A., Garibay, J. & Landsberger, S. Involving Engineering Students in Hands-on Rehabilitation Engineering Projects. Invited presentation for *Symposium on Developing a Rehabilitation Service Delivery Model for Minority Farmers with Disabilities*, New Orleans, Louisiana, August 3-6, 2003.
3. Landsberger, S. Invited Presentation and Attendee: Introducing Hands-on Rehabilitation Engineering Education for Minority and at-Risk Youth, *Capacity Building Workshop for Minority Involvement in Rehabilitation Research*, National Institute on Disabilities and Rehabilitation Research, Washington, DC, June 2002.

## **Insights on Integrating the Teacher-Scholar Model into the Tenure and Promotion Processes at a Teaching-Focused Engineering College**

Debra Larson

California Polytechnic State University, San Luis Obispo

### **Abstract**

Two surveys were conducted to gain insights about evaluating faculty work within the context of the teacher-scholar model at a primarily undergraduate engineering college that is part of a large state university system. Survey participants include college faculty and engineering deans from the system. The faculty results strongly reflect the baccalaureate mission of preparing graduates for the practice of their professions. This was evident in the responses to the question about preferred methods for evaluating faculty research. Private consulting was valued by the faculty, because it maintains disciplinary currency that is believed to support higher quality, state-of-the-practice learning environments. In many cases, the responses of the faculty and deans were similar. Both groups agree that “striking a balance between Retention, Promotion, and Tenure (RPT) standards and the teaching workload” is the most important reason for the review and revision of RPT criteria. They were in general agreement on the top four methods for evaluating teaching, including: student evaluations, self-evaluations, professional development, and peer review. They were in agreement on the methods for evaluating research and scholarship, including: self-evaluation, student participation, impact on teaching, development of new techniques, and judgments by colleagues from within the institution. Both groups disfavored evaluation by scholars external to the institution. Throughout the survey, the deans had stronger preferences than the faculty for externally validated artifacts of performance such as teaching awards, publications, and funding.

### **Background**

California Polytechnic State University San Luis Obispo (Cal Poly) is a member of the twenty-three California State University (CSU) campus system, which was created by the Donahoe Higher Education Act in 1960. This legislation followed the recommendations of A Master Plan for Higher Education in California 1960 - 1975, whereby different functions were assigned to the University of California, the CSU, and the California Community Colleges<sup>1</sup>. The CSU's primary mission was to prepare the state's workforce through superior teaching and service to students. Research assumed a minor role. This mission was modified by a 1989 revision of the Educational Code acknowledging the centrality of scholarship, research and creative activity to the CSU mission (CA 66010.4). This was followed by a 1997 Cornerstones Report<sup>2</sup> that identified these faculty activities as essential components of the CSU teaching-centered mission. Finally in 2007, the Provosts of the CSU asserted the importance of faculty scholarship to keeping California competitive in a global marketplace, and keeping faculty at the cutting edge of their disciplines so they can participate as a member of the world's scholars leading to enhancements of their teaching and student interactions<sup>3</sup>. The Provosts recommended strategies of reallocation, realignment, and reassignment to support and encourage increased faculty and student research and scholarship.

Like many of the CSU campuses, Cal Poly has been actively engaged in discussions involving the integration of scholarship into the work of its faculty. These activities included a late spring faculty-staff survey<sup>4</sup>, a student survey<sup>5</sup>, and an essay on the teacher-scholar model found in the WASC Capacity and Preparatory Review Report<sup>6</sup>. Of the 1,020 respondents to the faculty-staff survey, 401 represented the faculty and 75 were management personnel. Engineering represented 10.7% of the responding population. About 71% of the faculty and staff agreed or strongly agreed that incorporating scholarship into the learning environment had a positive impact on student learning. An inquiry into scholarly activities suggested an active faculty as exemplified by presenting at professional conferences (74%); publishing scholarly work (67%); consulting and/or collaborating with government, industry, and non-profits (63%); and editing and reviewing manuscripts for publishers (59%). In contrast, the survey suggested that the barriers to engaging in teacher-scholar activities were significant. Respondents identified the lack of sufficient resources for: travel and conference funding (61%); student research or teaching support (58%); release time (58%); administrative support for accounting, logistics, clerical (48%); lab or studio space (48%); and technical lab, shop, computer support (44%).

In consultation with the literature and a faculty task force, Conn and Giberti<sup>6</sup> proposed that the teacher-scholar is a faculty member who actively participates in both teaching and scholarship, engages students in their scholarship, and creates vibrant learning experiences that are informed by the scholarship of teaching. In 2011, the Cal Poly Academic Senate adopted a definition for the teacher-scholar model as resolution AS-725-11<sup>7</sup>.

The Cal Poly Academic Senate's teacher-scholar model is strongly premised on Boyer's seminal text on scholarship and the role of scholarship in the academy<sup>8</sup>. Through his conceptualizations, Boyer offers a broader view of scholarship that goes beyond traditional forms of published research. By underpinning AS-725-11 to Boyer, the resolution's meaning is enriched and made more robust. It provides an overarching vision for all departments and colleges that could include Boyer's four types of scholarship (discovery, application, integration, and teaching), the engagement of students in scholarship, the positive relationship between the scholarship of teaching to high quality learning environments, and the provisions for individual variations in the balance of contributions.

In spring 2012, Cal Poly's Academic Senate passed a second resolution, AS-752-12, requesting the Provost to direct all departments and colleges to "review and approve RPT (retention, promotion, tenure) guidelines in a discipline-specific manner," and to align criteria and definitions to the teacher-scholar model<sup>9</sup>. Provost Enz Finken<sup>10</sup> delivered a formal charge to departments and colleges to complete this work "in order to create a sustainable and rewarding career for faculty."

In response and in preparation for a college-level review, the author completed two surveys on the current methods and issues of RPT for Cal Poly engineering and CSU engineering. The intent was to gain insights about evaluating faculty work within the context of the recently established teacher-scholar ethos at Cal Poly. This paper presents the results of these two surveys, which were conducted in December of 2012, followed by a discussion and conclusions.

## **The Survey and Respondents**

The survey was developed by borrowing heavily from a national survey previously conducted by The Carnegie Foundation as reported on by Glassick, Huber, and Maeroff<sup>11</sup>. This national survey on faculty roles and rewards was completed in 1994 by 865 chief academic officers (e.g. Provosts) representing the full range of university types from Research to Comprehensive to Liberal Arts. Questions 1, 3, 6, 7, 8, 10 of the national survey were adapted to better fit the CSU and Cal Poly context of today, while forming the basis of this current study. Two versions of the survey were developed; one for making inquiries with the deans of engineering within the CSU and the other for the engineering faculty at Cal Poly.

Six questions were common to both populations. Three questions focused on the evidence used to support the evaluation of performance for teaching and research, one question on the meta-goals of the RPT process, another on the role of faculty consulting in RPT, and a general comment section. The dean's survey included college-level questions to learn if Boyer's four types of scholarship were valued along with information on teaching workload and RPT revision activities. The faculty survey included additional questions about private consulting.

Seventeen of the twenty-three Cal State system universities offer engineering with full and part-time undergraduate enrollment ranging - in the fall of 2012 - from a high of 5062 at Cal Poly SLO to a low of 120 at CSU-Bakersfield. The deans of such programs meet annually. At their December 2012 meeting, the dean's survey was administered in paper form and ten deans responded anonymously. Similarly, the faculty survey was conducted at a college-wide meeting, also in December of 2012. At the time of this survey, the tenured and tenure-track faculty numbered 120 including faculty on the early retirement program. Thirty-one tenured and tenure-track faculty of the College of Engineering responded to one or more of the survey questions. Not every respondent answered every question and the corresponding result summaries reflect this. Both surveys are found in the appendix to this document.

### **Survey Results**

In addition to reporting on the survey results of the CSU engineering deans and the Cal Poly engineering faculty, other comparable national survey results are noted here. These surveys included: the 1994 National Survey<sup>11</sup>, the 1993 National Survey of Postsecondary Faculty as reported by Fairweather<sup>12</sup> and the American Association for Higher Education 2001-2002 national survey of chief academic officers<sup>13</sup>. Cal Poly and most of the other CSU institutions are currently classified by the Carnegie Foundation's classification system as "Master's College and Universities." However, at the time of the 1994 National Survey, these institutions would have been designated as "Comprehensive" – an institution that offered baccalaureate programs and graduate education through the master's degrees with more than half of the baccalaureate degrees in two or more professional disciplines.

*Revising college RPT criteria, valuing Boyer's and teaching workload.* Nine of the ten CSU engineering deans responded in the affirmative; their respective college is currently in the process of reexamining, or has recently reexamined, their RPT criteria. Seven of the ten deans reported that teaching and other instructionally-related duties occupy 80% of their faculty's academic year work load. This 80% load is the working standard for faculty of the CSU. The remaining three deans moderated teaching loads as a function of research activity. In one case, the untenured assistant professors carry a 40% instructional load, the tenured faculty who are active in research carry a 60% instructional load, and everyone else carries the standard 80%



load. Information on mean student contact hour data from the 1993 National Survey of Postsecondary Faculty<sup>12</sup> is helpful in providing a national context to this 80% instructional workload. He reported a mean value of 335 student contact hours per week per faculty for the responding comprehensive institutions. In contrast, an 80% instructional load in the CSU is approximately equivalent to 360 student contact hours per week per engineering faculty member. This work load is calculated by assuming: two, three-unit lecture courses and three, one-unit labs. Forty-student lecture courses meet for one hour, three times a week. Each lab meets once a week for three hours with twenty students per lab.

Only three of the nine responding CSU engineering deans affirmed that their respective colleges give equal weight and recognition during the RPT process to Boyer's four types of scholarship. Four colleges unequivocally stated "no" to this question, with one dean further specifying that they "expect journal and/or selective conference proceedings in standard research." In comparison, the AAHE question of "What degree of influence do issues have on the final decision by faculty committees to recommend or deny tenure and promotion?" reveals the top three issues (listed in rank order): publishing of scholarship, institutional mission, and impact of scholarship on students<sup>13</sup>.

*Common questions on reviews and values, teaching, research/scholarship.* Table 1 shows the comparative results between the faculty and deans in their response to the question: "If you were to review your RPT and periodic evaluation procedures, rank the importance of the following issues to such a review with 1 = most important and 6 = least important. As shown, the deans and faculty agree on the most important issue to incorporate in a review, which is: Striking a balance between RPT standards and teaching workload. The deans also value the need to define and integrate the teacher-scholar model into RPT. In contrast, the responding members of the faculty were neutral on this. The least important issue to RPT as identified by both populations is: Meeting the challenges facing higher education in this decade and beyond. Finally, the issue of productivity thresholds received a strongly bi-modal response from the faculty: half who identified this as most important, and half who identified this as least important. Similarly the faculty comments on thresholds ranged from this is "key" to this is a "bad idea." The deans, as a group, were neutral on this same question.

Table 1. Relative importance of various issues to a potential review of faculty RPT processes as judged by Cal Poly engineering faculty and CSU engineering deans. 1 = most important, 6 = least important

	Weighted Average	
	Faculty n=28	Deans n=8
Linking to current institutional and/or college mission	3.00	3.57
Defining the engineering teacher-scholar & integrating into RTPT	3.11	2.29
Striking a balance between RPT standards and teaching workload	1.86	2.25
Meeting the challenges facing higher education in this decade and beyond	3.85	4.14
Creating a generally accepted definition of scholarship	3.33	3.75
Identifying specific productivity thresholds for tenure and promotion	3.59	3.00

The 1994 National Survey<sup>11</sup> contained a similar question of importance to review, but with a twist. They asked the question: “Have any of the following issues been the focus of your review?” Ninety-one percent of the comprehensives reported on redefining faculty roles as a focus, followed by seventy-nine percent intending to improve the balance of time and effort faculty spend on various tasks.

The Cal Poly faculty and CSU deans were asked to judge the value of eleven activities towards faculty review and advancement by judging if certain activities count more or less today than they did five to ten years ago. In the case of faculty, nine of the eleven activities were judged to count more today. Only professional activities (e.g. national committee work, etc.) and consulting were judged to count nearly the same today as ten years ago by the faculty. These results are displayed as Figure 1.

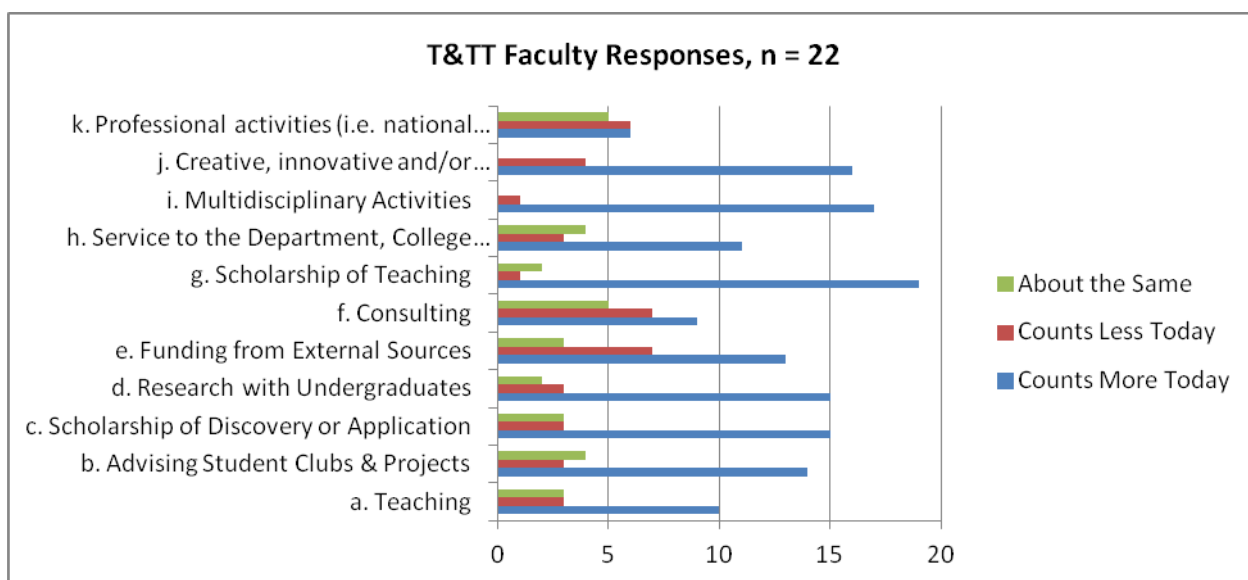

Figure 1. Cal Poly engineering faculty summary responses to the question: Thinking about our college, should the following faculty activities count more or less today – for the purposes of faculty advancement – than they did ten years ago?

In contrast, the engineering deans rated only four of the eleven activities as more important. These four activities are: traditional research; research with undergraduates; funding from external sources; and creative, innovative or entrepreneurial activities. Teaching; advising student clubs and projects; and service to the department, college or university were judged by the deans to count about the same today as they did five years ago. A majority of the comprehensive universities per the 1994 National Survey<sup>11</sup> reported that professional activities and service to the institution held steady in value over time. Teaching rose in value at 58% of the responding comprehensive institutions. In the case of research, the responses were equally mixed between holding steady over time or counting more. In contrast, publication productivity counted more at 51% of the responding institutions per the 2001-2002 AAHE survey<sup>13</sup>. All other activities - teaching, professional service and service to the institution counted about the same as they did ten years ago.

The Cal Poly faculty and the CSU deans were in general agreement on the top four methods for evaluating teaching, which included: 1. Student evaluations, 2. Self-evaluation or personal statement, 3. Professional development, and 4. Peer review of classroom teaching. The deans also favored awards and other formal recognitions of teaching, while the faculty valued student achievement. The opinions of alumni were not valued by either the deans or the faculty. This data is summarized in Figure 2. The 1994 National Survey<sup>11</sup> results from the comprehensive universities showed that the top methods used included: 1. Student evaluations (98%), 2. Self-evaluation or personal statement (83%), 3. Peer review of syllabi, examinations and other teaching materials (70%), and 4. Peer review of classroom teaching (63%). About a third of the responding institutions also used evidence of student achievement, continuing student interest, and alumni opinions.

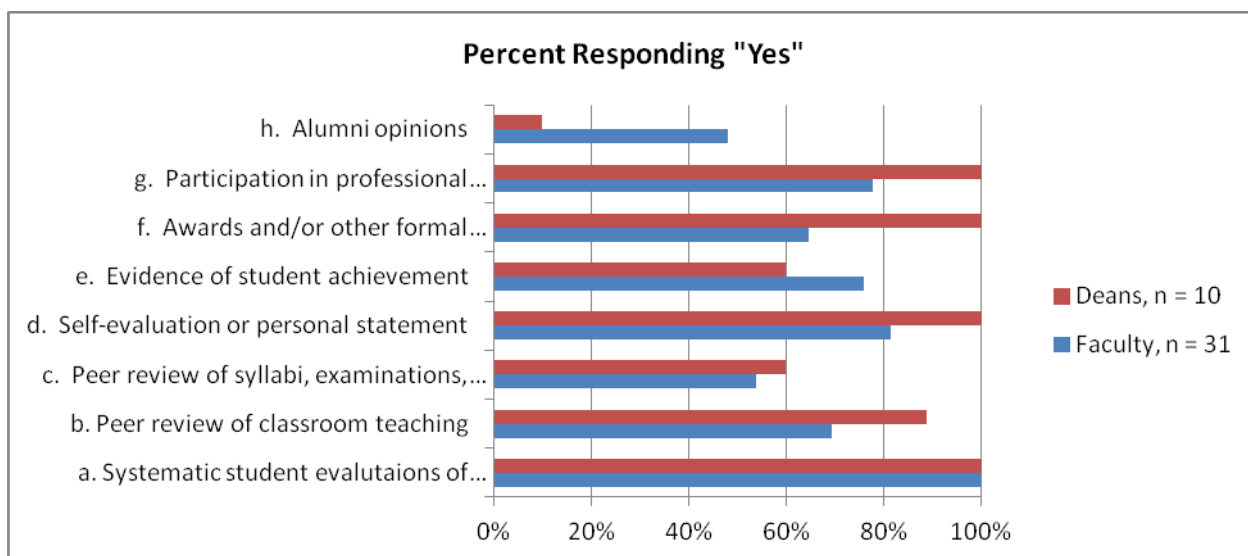

Figure 2. Cal Poly engineering faculty and CSU engineering deans responses to the question: Regarding teaching, which of the following methods should be used, or are in use in the evaluation of faculty in your college?

The Cal Poly faculty and engineering deans strongly agree on the top two methods for evaluating research and scholarship, which are: 1. Self-evaluation or personal statement, and 2. Evidence of student participation in research. Agreement is also found, although not as strong, on: 3. Evidence on the project's impact on teaching, 4. Development of new techniques, and 5. Securing judgments by colleagues within the institution. There is strong disagreement between the faculty and deans on the criteria of counting publications and presentations, and levels of funding. Eighty percent of the responding deans reported that their colleges included these two methods in their evaluation process. Both the faculty and deans were equally disinclined to utilize the review and evaluation of outside scholars. This data is summarized in Figure 3.

The results from the comprehensive universities from the 1994 National Survey<sup>11</sup> showed that the top methods for evaluating research and scholarship included: 1. Self-evaluation or personal statement (75%) and 2. Securing judgments by colleagues within the institution (70%). Counting publications and presentations were used by 58% of the respondents, evidence of a research project's impact on teaching were considered by 46%, and evidence of student participation in

research was considered by 36%. In contrast and as expected, research institutions responded with different results; presented here in rank order of frequency: 1. Securing judgments by outside scholars (100%), 2. Securing judgments by colleagues from within the institution (93%), 3. Counting numbers of publications and presentations (87%), and 4. Self-evaluation or personal statement (69%). Only 21% of the responding research institutions utilized evidence on the research project's impact on teaching and 25% tracked student participation in research.

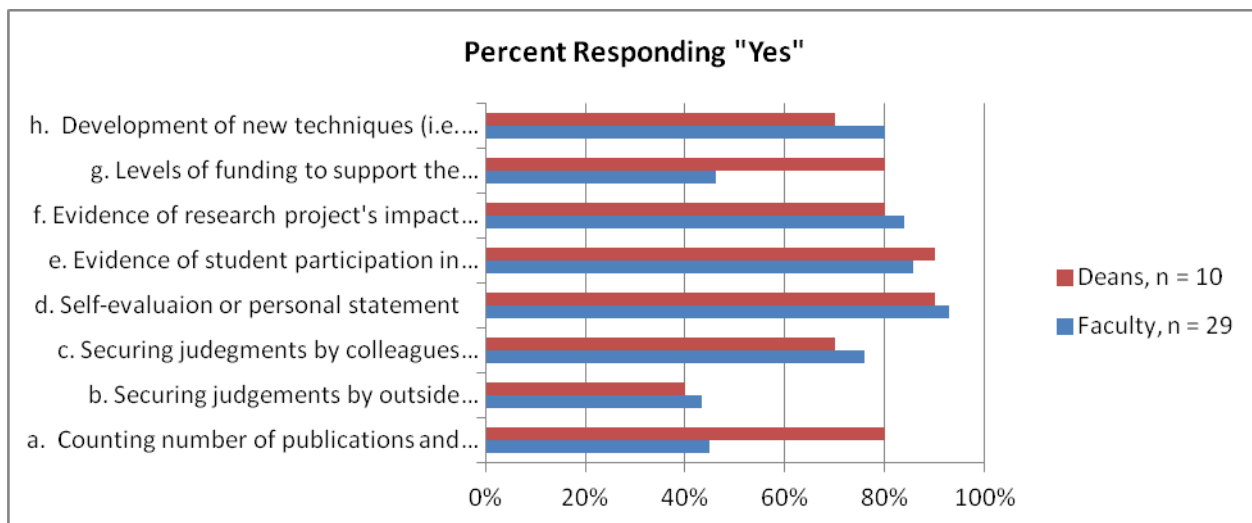

Figure 3. Cal Poly engineering faculty and CSU engineering deans responses to the question: Regarding research or scholarship, which of the following methods should be used, or are in use in the evaluation of faculty in your college.

*Consulting.* The Cal Poly engineering faculty value the role of private consulting and its place in the RPT process with 58% and 27% respectively responding "yes" or "maybe" to the question: Should consulting be valued in the RPT process? This data is summarized in Table 2. Those who provided additional comments, however, qualified their response by linking consulting importance to the teaching and learning environment. Consulting is viewed as a mechanism for keeping the faculty current in the practice of their respective disciplines, which is believed to contribute to higher quality learning environments that reflect the state-of-the-practice.

Table 2. The value of consulting in the RPT process as judged by Cal Poly engineering faculty and CSU engineering deans

	Yes	No	Don't Know	Maybe
Faculty	15 58%	2 8%	2 8%	7 27%
Deans	2 22%	5 56%	0 0%	2 22%

The deans judged the value of consulting differently than the faculty. Their responses were biased towards the negative. When the deans acknowledged the possibility of consulting have a role, they did so within the framework of research; including peer-review as an important component of the review of associated consulting activities. No dean connected consulting to teaching and its possible role in maintaining high-quality learning environments.

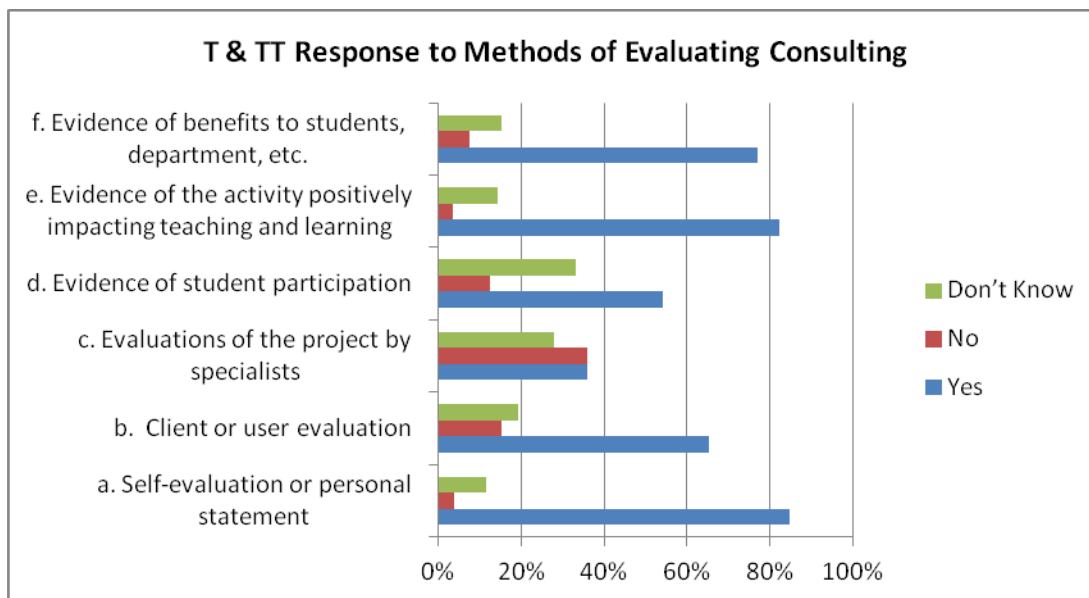

Figure 4. Cal Poly engineering faculty response to: Regarding consulting, which of the following methods of evaluation should be used?

Figure 4 further substantiates the earlier observation that the faculty value consulting because of its relationship to quality learning environments. Two of the top three methods for evaluating the merits of consulting during the RPT process were its relationship to positively impacting the teaching and learning environment and its benefit to students and the department. Self-evaluation was the preferred method for evaluating the merits of consulting.

### Discussion and Conclusions

Although 90% of the responding CSU engineering deans reported that their college has been or is currently active in reviewing their respective RPT documents, the survey did not ask for an explanation for “why.” The author speculates that the nation-wide impacts of reduced state funding with demands of more accountability, more effectiveness, and more productivity have firmly landed at the CSU, as well. The conditions under which the CSU and Cal Poly conducts itself have clearly changed since 1990 when the State of California funded over 90% of our student's costs to attend Cal Poly. As a result, the identity and professional responsibilities of the faculty are similarly being impacted and further encouraged by nation-wide trends. This is supported by the 2007 CSU Provosts' statement<sup>3</sup> supporting increased faculty and student scholarship to encourage a more active connection of the faculty to their disciplines. As reported through the AAHE survey, the catalysts for changing faculty evaluation policies to encourage and reward multiple forms of scholarship were primarily due to institutional commitments to teaching, leadership by the institution's provost, and alignment of the reward system with

intuitional mission and goals<sup>13</sup>. Locally, the adoption of the teacher-scholar model by Cal Poly's Academic Senate is compelling faculty-wide discussions about the role of scholarship at our undergraduate-focused institution.

As shown by the Cal Poly survey results, the engineering college's faculty is conflicted about the teacher-scholar model; reflecting the full range of beliefs from prioritizing research above all else to only valuing teaching, and from being fully supportive to non-supportive of consulting. And, generally speaking, those who strongly value research were not as supportive of consulting as those who prioritize teaching as the focus of the faculty's work. The faculty, along with the CSU deans and companion survey results, express the need to carefully balance teaching workloads with enhanced RPT expectations for scholarship.

The faculty survey results say that most of the regular activities of the professoriate (teaching, advising student clubs and projects, scholarship, research with undergraduates, funding, scholarship of teaching, service, multidisciplinary work, and creative or innovative endeavors) are being judged today to count more towards faculty advancement than they did ten years ago. Perhaps this is indicative of the "overloaded plate," whereby the standard of heavy teaching and advising loads have held steady over the fifty years of the CSU, while the movement towards scholarship grows. Cal Poly, not unlike the baccalaureate institutions of O'Meara<sup>14</sup>, has been encouraging any form of scholarship, even professional development, among its faculty, who are fully devoted to teaching and advising. With clarity on quality and quantity of scholarship, the overloaded plate is real. Certainly, the CSU dean's emphasis on the growing importance of non-teaching and non-service activities reflects these existing trends in workload and expectations.

As suggested by O'Meara<sup>14</sup>, the overloaded plate syndrome can be mitigated by presenting clear expectations for scholarship in promotion and tenure guidelines. And, clarity can lead to healthier work environments. Rockquemore<sup>15</sup> observes that faculty from colleges with clearly defined tenure and promotion criteria had confidence and "were focused on doing excellent work to exceed" the criteria. Without, members of the faculty are "confused about what it would take to meet unspecified and ever-escalating tenure criteria." Finally, the research on the optimal performance of employees<sup>16</sup> is supported by having clarity on performance expectations and by flexibility in meeting personally challenging goals.

There is general agreement on the primary methods for evaluating teaching between faculty, deans, and CAOs. Agreement for the evaluation of research by these three groups is found only with the techniques of self-evaluation or personal statements, and the inclusion of students. Within the CSU, the survey suggested a nearly universal disinclination for external peer review. The deans and CAOs also valued the counting publications and presentations and levels of funding. Those CAOs from research institutions universally valued external peer reviews over all other techniques followed by counting publications and presentations. Within the area of research, the differences between what it means to be from a research vs. a comprehensive institution are readily apparent in the methods of evaluation. The research institutions prioritize external reputation and peer review evidence above all else, while the teaching-centric institutions more readily connect research and scholarship to the student learning environment.

Consulting is valued by the faculty as a professional development activity, because of its logical relationship to our instructional mission and professional school orientation. The survey results

speak clearly to this relationship between currency and quality instruction. Similarly, members of Cal Poly engineering faculty regularly take advantage of short-term summer or sabbatical employment opportunities – a faculty internship, if you will. These opportunities provide our faculty with valuable experiences in the state-of-the-art of their profession, which often translate directly back to the maintaining high-quality, state-of-the-profession education. The value of this professional development to the faculty member and our students is not in question. It does not, however, meet the test of scholarship unless the faculty member carefully constructs his or her consulting or internship activities to incorporate dissemination, critique, and reflection. Cal Poly's teacher-scholar resolution is silent on professional development - most likely so, because while all scholarship contributes to professional development, most professional development activities do not meet the tests of scholarship.

Boyer's Scholarship Reconsidered reframed the conversation of faculty scholarly work and began the process of thinking about the alignment of faculty priorities with the institutional mission. It was intended to bring wholeness through the teacher scholar. Faculty are more than members of the university focusing on three areas of activities (teaching, research, and service), they are also scholars - members of an intellectual community who with professionalism and skill bring deep meaning and creative solutions to the world around us. The results of these two surveys provide insights useful to the successful integration of the teacher-scholar model into the RPT guidelines of primarily undergraduate institutions.

## References

1. CSU. 2009. Historic Milestones. <http://www.calstate.edu/explore/milestones.shtml> (date accessed: 9/8/2013).
2. CSU. 1997. The Cornerstones Report: Choosing our future. December. [http://www.calstate.edu/cornerstones/reports/cornerstones\\_report/](http://www.calstate.edu/cornerstones/reports/cornerstones_report/) (date accessed: 9/9/2013).
3. CSU. 2007. The role of research, scholarship, and creative activities in the CSU. Provost's statement and recommendations. Unpublished. April.
4. Giberti, B., Henry, R. and K. Wilson. 2009. Faculty-Staff WASC Survey. California Polytechnic State University. April-May. [http://wasc.calpoly.edu/pdfs/cpr\\_drafts/faculty\\_staff\\_survey\\_2009\\_cpr\\_web.pdf](http://wasc.calpoly.edu/pdfs/cpr_drafts/faculty_staff_survey_2009_cpr_web.pdf) (date accessed: 9/23/2013).
5. DeVane, K. 2009. University learning objectives survey and diversity learning objective survey. CSU, Office of the Chancellor. Feb. 27. [http://wasc.calpoly.edu/pdfs/cpr\\_drafts/student\\_survey\\_2009\\_ulo\\_cpr.pdf](http://wasc.calpoly.edu/pdfs/cpr_drafts/student_survey_2009_ulo_cpr.pdf) (date accessed: 9/9/2013).
6. Conn, W.D. and B. Giberti. 2009. Our Polytechnic Identity in the 21<sup>st</sup> Century. WASC Capacity and Preparatory Review Report. California Polytechnic State University. December. [http://wasc.calpoly.edu/pdfs/cpr/cpr\\_essays\\_web.pdf](http://wasc.calpoly.edu/pdfs/cpr/cpr_essays_web.pdf) (date accessed: 9/9/2013).
7. Academic Senate of California Polytechnic State University. 2011. Resolution on defining and adopting the teacher-scholar model. AS-725-11. March 8.
8. Boyer, E.L. 1990. Scholarship reconsidered, priorities of the professoriate. The Carnegie Foundation for the Advancement of Teaching. Jossey-Bass Publishers.
9. Academic Senate of California Polytechnic State University. 2012. Resolution on retention, tenure and Promotion. AS-752-12. May 29.
10. Enz Finken, K. 2012. Retention, promotion, tenure charge to departments and colleges. Internal memo of the California Polytechnic State University. October 15.
11. Glassick, G.E., Huber, M.T. and G.I. Maeroff. 1997. Scholarship Assessed: Evaluation of the Professoriate. The Carnegie Foundation for the Advancement of Teaching. Jossey-Bass Publishers.
12. Fairweather, J.S. 2002. The mythologies of faculty productivity: Implications for institutional policy and decision making. The Journal of Higher Education. Vol. 73. No. 1. Special Issue: The Faculty n the New Millennium. Jan-Feb. pp. 26-48. <http://www.jstor.org/stable/1558446> (date accessed: 9/25/2013).

13. O'Meara, K. 2005a. Effects of encouraging multiple forms of scholarship nationwide and across institutional types. In: Faculty Priorities Reconsidered: Rewarding Multiple Forms of Scholarship by K O'Meara and R. E. Rice. John Wiley & Sons, Inc. pp. 255-289.
14. O'Meara, K. 2005b. Principles of Good practice: Encouraging multiple forms of scholarship in policy and practice. In: Faculty Priorities Reconsidered: Rewarding Multiple Forms of Scholarship by K O'Meara and R. E. Rice. John Wiley & Sons, Inc. pp. 290-302.
15. Rockquemore, K.A. 2011. The missing guidance. Inside Higher Ed. December 14. <http://www.insidehighered.com/advice/2011/12/14/essay-need.clear-tenure-and-promotion-guidelines> (date access: 10/23/2013).
16. LePine, J.A., Podsakoff, N.P., and M.A. LePine. 2005. A meta-analytic test of the challenge stressor-hindrance stressor framework: An explanation for inconsistent relationships among stressor and performance. Academy of Management Journal. 48. pp. 764-775.

## Appendix

### College-Wide Survey on the Teacher-Scholar, December 6, 2012

1. As we embark upon the charge to review our RPT and periodic evaluation processes, rank the importance of the following issues to such a review. 1 = most important, 6 = least important.

_____	Linking to current institutional and/or college mission
_____	Defining the engineering teacher-scholar & integrating into RPT
_____	Striking a balance between RPT standards and teaching workload
_____	Meeting the challenges facing higher education in this decade and beyond
_____	Creating a generally accepted definition of scholarship
_____	Identifying specific productivity thresholds for tenure and promotion

2. Thinking about our college, should the following faculty activities count more or less today - for purposes of faculty advancement - than they did ten years ago?

	Counts More Today	Counts Less Today	About the Same	Don't Know
a. Teaching				
b. Advising student clubs or co-curricular projects				
c. Scholarship of discovery or application				
d. Research with undergraduate students				
e. Funding from external sources				
f. Consulting				
g. Scholarship of teaching				
h. Service to the department, college or university				
i. Multi-disciplinary activities				
j. Creative, innovative and/or entrepreneurial activities				
k. Professional activities (i.e. national committees, etc.)				
l. Other (please specify)				

3. Regarding teaching, which of the following methods of evaluations should be used?

	Yes	Now	Don't Know
a. Systematic student evaluations of classroom teaching			



b. Peer review of classroom teaching			
c. Peer review of syllabi, examinations, and other materials			
d. Self-evaluation or personal statement			
e. Evidence of student achievement			
f. Awards and/or formal recognition			
g. Participation in professional development activities			
h. Alumni opinions			
i. Other (please specify)			

4. Regarding scholarship which of the following methods of evaluation should be used?

	Yes	No	Don't Know
a. Counting number of publications and/or presentations			
b. Securing judgments by outside scholars			
c. Securing judgments by colleagues from within the institution			
d. Self-evaluation or personal statement			
e. Evidence of student participation in research project			
f. Evidence of a research project's impact on teaching			
g. Levels of funding to support the research			
h. Development of new techniques (i.e. applied, teaching)			
i. Other (please specify)			

5. Should consulting be valued in the RPT process? Please explain your answer.

6. Regarding consulting, which of the following methods of evaluation should be used?

	Yes	No	Don't Know
a. Self-evaluation or personal statement			
b. Client or user evaluation			
c. Evaluations of the project by specialists			
d. Evidence of student participation			
e. Evidence of the activity positively impacting teaching & learning			
f. Evidence of benefits to Cal Poly students, department, etc.			
g. Other (please specify)			

7. If you wish to provide additional comments, please do so here. Thank you!

### CSU Engineering Deans' Survey on the Teacher-Scholar, December 7, 2012

1. In the past five years or so, has your college reexamined your faculty retention, tenure, and promotion (RTP) criteria?
2. If you were to conduct a review of faculty roles and rewards, rank the importance of the following issues to such a review. 1 = most important, 6 = least important.  
 \_\_\_\_\_ Linking to current institutional and/or college mission

- \_\_\_\_\_ Defining the engineering teacher-scholar & integrating into RPT
- \_\_\_\_\_ Striking a balance between RPT standards and teaching workload
- \_\_\_\_\_ Meeting the challenges facing higher education in this decade and beyond
- \_\_\_\_\_ Creating a generally accepted definition of scholarship
- \_\_\_\_\_ Identifying specific productivity thresholds for tenure and promotion

3. Thinking about your own situation, do the following faculty activities count more or less today - for purposes of faculty advancement - than they did five years ago?

	Counts More Today	Counts Less Today	About the Same	Don't Know
a. Teaching				
b. Advising student clubs, co-curricular projects or similar				
c. Traditional research				
d. Research with undergraduate students				
e. Funding from external sources				
f. Consulting				
g. Scholarship of teaching				
h. Service to the department, college or university				
i. Multi-disciplinary activities				
j. Creative, innovative, and/or entrepreneurial activities				
k. Professional activities (i.e. national committees, etc.)				
l. Other (please specify)				

4. Does your college have a standard base teaching load for tenure and tenure-track faculty? If so, could you please state what that is in terms of percent time, such as 80% of the member's time is devoted to instruction and related activities.
5. Does your college give equal recognition and weight in the RTP processes to Boyer's four types of scholarship (basic-discovery, application, integrating, and teaching)? Please explain.
6. Regarding research, which of the following methods of evaluation are generally used in faculty evaluation in your college?

	Yes	No	Don't Know
a. Counting number of publications and presentations			
b. Securing judgments by outside scholars			
c. Securing judgments by colleagues within the institution			
d. Self-evaluation or personal statement			
e. Evidence of student participation in research project			
f. Evidence of a research project's impact on teaching			
g. Levels of funding to support the research			
h. Development of new techniques (i.e. applied or teaching)			
i. Other (please specify)			

7. Regarding teaching, which of the following methods of evaluation are generally used in faculty evaluation in your college?

	Yes	Now	Don't Know
a. Systematic student evaluations of classroom teaching			
b. Peer review of classroom teaching			
c. Peer review of syllabi, examinations, and other materials			
d. Self-evaluation or personal statement			
e. Evidence of student achievement			
f. Awards and/or other formal recognitions			
g. Participation in professional development (of teaching) activities			
h. Alumni opinions			
i. Other (please specify)			

8. Do you and your college consider consulting as a valued activity towards RTP? If you do, please describe the methods utilized for evaluating.
9. Please summarize anything else you would like to say about RTP and/or this survey. Thank you!

## Undergraduate Courses to Professional Engineering Design: A Disconnected Trajectory?

Carlye Lauff, Joanna Weilder-Lewis, Kevin O'Connor,  
Daria Kotys-Schwartz, and Mark Rentschler  
University of Colorado, Boulder

### Abstract

This exploratory, ethnographic study compares engineering design in different organizational settings, as a way of examining the nature of claimed disconnects between professional engineering design practices and those taking place in the undergraduate engineering curriculum. The focus in this research is on three different design contexts. Two are set in a large public university in the United States, a general engineering freshman cornerstone design course and a senior Mechanical Engineering design capstone course. These were analyzed through observations and other ethnographic methods. The third design setting is professional engineering companies. This setting was analyzed through the research team's experiences working on design teams for multiple companies. Data suggests that engineering education and industry organizational contexts constitute processes of design differently. These findings challenge the typical rhetoric that undergraduate education project courses are intended to provide students with real-world design experiences.

### Introduction

Engineering design has been defined as a systematic, cognitive process in which a team generates, evaluates, and determines concepts that they then use to create an artifact whose purpose is to achieve clients' objectives or users' needs, while satisfying a specified set of design constraints.<sup>1,2</sup> This process of design is "widely considered to be the central or distinguishing activity of engineering,"<sup>1,3</sup> yet it remains an insufficiently researched and understood topic.<sup>1,4-8</sup> There is strong evidence, through an extensive literature review, that supports how an inadequate picture of engineering work, including design, is conveyed to the general public.<sup>7</sup> Currently, "real engineering," or that of professional engineering companies, is portrayed based on personal experience or anecdotal evidence that usually highlights only the technical aspects of the work.<sup>9,10</sup>

In the field of engineering education, the sparseness of research on professional engineering work is worrisome.<sup>4</sup> Engineering education is often organized and reorganized against the backdrop of claims about what professional engineering work is like currently or will be like in the future. Without truly understanding the organization of professional engineering design, it is impossible for engineering educators to know whether or not engineering education is preparing engineering students to be productive engineers upon graduation. It has been reported that engineering graduates are lacking skills necessary for the "real-world." Engineering graduates are perceived by industry and academia as being unable to practice in industry because of the heavy undergraduate emphasis on theoretical engineering aspects rather than hands-on applications.<sup>11</sup> Additionally, a prominent consensus report from the National Academy of Engineering highlights a "disconnect between engineers in practice and engineers in academe" and points out that "[i]ndustry representatives point to this disconnect as the reason that engineering students are not adequately prepared, in their view, to enter today's workforce."<sup>12</sup> Actual observations of professional engineering work are critical resources for rethinking

engineering education and making empirically based assessments of student progress. It has been urged to make design pedagogy the highest priority in new engineering education curriculum decisions.<sup>1</sup> “Design is what engineers do, and the intelligent and thoughtful decision of the engineering curriculum should be the community’s first allegiance.”<sup>1</sup>

This evident gap in new engineers’ preparation plus the lack of research around professional engineering are the motivation for this research, which attempts to understand differences between universities and companies with greater specificity through direct observation and recordings. Currently, there is a small empirical base on what contemporary professional engineering practice involves.<sup>3-9,13-15</sup> However, even this small percentage of professional studies have not made direct comparisons between the workplace and educational experiences. This current research project is aimed at making these needed direct comparisons through a side-by-side study of both undergraduate engineering design courses and professional engineering design companies. This is an on-going research project that will begin observing professional engineering companies in the same geographical region to enhance these comparisons. However, until then, the research in this paper focuses on further understanding the design courses in the undergraduate curriculum and then comparing these findings to the research team’s experiences working on design teams in companies.

### **Discussion of a Design Trajectory**

A trajectory is the path a person is on that can be impacted by many external and internal factors including their location (*i.e.*, environment, geographical position), profession, and desires. A design trajectory is the linkage of design experiences throughout an engineer’s life. Each design experience gives the participant a new view of the process and directly impacts their future design endeavors. Since this research project is focusing on two distinct environments, undergraduate and professional, it can be assumed that the design trajectories will be different for each. An undergraduate engineering student’s trajectory is heavily influenced by their chosen major. Undergraduate engineering curricula is heavily regimented with few allowed electives, making the selection of these classes important in framing the students’ future goals. In the professional world, an engineer’s trajectory is based on a number of factors. This trajectory, unlike undergrad, is closely linked to the engineer’s skillset, company needs, business acquaintances, relationships, and the projects the engineer is assigned to or works on at the company.

These design trajectories for engineers have multiple layers, as seen in Figure 1. On the outermost surface, trajectories can be compared based on how engineers move from one project to the next. This takes into account the type of project, length of project, design location, team formation, and other external factors that inevitably impact the project. The relationships built with the team members also impact the design experience. However, these design trajectories can be subject to closer observation. By meticulously observing different design settings, less obvious interactions are captured. Each design team approaches the design project differently based on their location and prior experiences. Furthermore, these teams have a certain amount of diversity within them, whether that is divided by majors, prior experiences, age, or other demographic factors. Each design team also has a certain level of motivation, along with a procedure for how they are evaluated during and after their work on the team. By capturing these inner layers of the trajectory, even closer comparisons can be made between different design

trajectories for engineers. An analysis of the differences in the design trajectories can be viewed in the *Overall Findings* section.

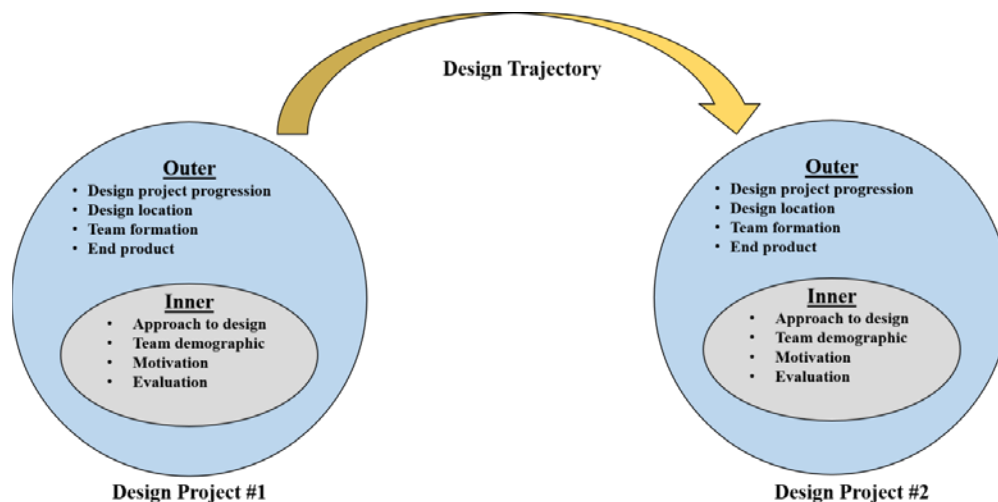

Figure. 1. Design team trajectory where the more obvious (outer) and less obvious (inner) parts of project #1 directly impacts a person's trajectory to project #2.

### Research Setting

This exploratory study took place in a medium-sized city in the United States. It is part of a larger, ongoing study whose efforts focus on comparing undergraduate design courses and professional engineering design companies side-by-side. The undergraduate engineering classes analyzed in this paper were at a large, public university. The professional engineering design comparison in this paper was taken from observations in the research team's prior design experiences in industry. In the future, the comparison will also be with medium-sized companies in the same geographical region.

*Cornerstone Design Course.* The first undergraduate course observed in this study was a cornerstone engineering design course created for all engineering majors. There are no prerequisites for taking this course, as it is encouraged to take within the first year of starting the engineering program (*i.e.*, either the first or second semester). Aerospace, Mechanical, and Civil Engineering are the only majors to require this three-credit, first-year design course. This course is often the first time students have the opportunity to experience the design process in college. The students are able to imagine, create, build, test and present their own product. Most of the time spent executing the design process is during class, with minimal time and effort spent outside of class working on the project. This cornerstone design course has specific deadlines and due dates throughout the semester that helps to maintain the flow of the class.

During this study, there were ten different sections of the cornerstone design course offered during one semester (fifteen weeks total), but this research project only observed one of these sections. This was a relatively small class that had thirty students (twenty male, ten female), one female Professor from the Department of Mechanical Engineering, and two male Teaching Assistants, whom are both enrolled in the concurrent B.S./M.S. Mechanical Engineering program. The students in this section were then broken down into six teams with five students on

each team. Teams were created based on social styles quizzes, which are proven to help with team effectiveness.<sup>16</sup> Teams did not have specific roles for each student, meaning that positions developed organically throughout the semester. Some of the roles that evolved were Project Manager/Communications Director, CAD Engineer, Materials Engineer, and Manufacturing Engineer. Although the entire class was observed, only one of these six teams was followed rigorously throughout the semester to gain a more in-depth look at how design is constructed in a cornerstone design course. This particular section focused on designing products that positively impacted the environment, and each team determined the final scope and direction of the project. The projects ranged from improving a wind turbine farm layout, to creating recyclable insulation material, to even building a bicycle that filters water. At the end of the semester, all teams from every section competed in a Design Expo where the best team in each section was awarded a prize by the guest industry judges. Once the Design Expo was over, students were encouraged to either keep or recycle their projects. The final products of the team were essentially disposable as soon as the semester ended. This cornerstone design is a pre-requisite for Mechanical Engineering senior capstone design, which occurs three years later in the curriculum. Not all engineering majors require that cornerstone design is taken prior to capstone enrollment, and furthermore, not all engineering majors require a capstone design course at all.

*Capstone Design Course.* The second undergraduate course observed in this study was a capstone engineering design course for Mechanical Engineering seniors. There are several pre-requisites for this course, including much of the technical coursework taken during the sophomore and junior years: therefore, this course is usually taken during a student's last year in the program. All Mechanical Engineering students are required to take this two-semester, six-credit total course in order to graduate. There are 165 students in this class, which breaks down into 28 different teams with six people on each team. Each person on the team decides on a "lead position" that they will take-on for the year. The positions are Project Manager, Financial Director, Communications Director, Manufacturing Engineer, Systems Engineer, and CAD Engineer. These are all sponsored design projects, where the paying company or client proposes a project, creates expected deliverables, and retains the intellectual property from the design. Teams must bid on which company they want to work for, and then the company ultimately chooses the final team to work with them. The teams then have a set budget from their client that they use to solve the company's problem. This course is set-up much like a company experience in that the Professor of the class, a female from Mechanical Engineering, acts as a higher-level manager in the company. The Professor has "morning meetings" with the whole class for about half of the semester. There is lab time built into the students' schedule for this course, allowing them to have this time to meet and work on the project. However, this does not mean that all 165 students meet in an assigned room for this lab, but rather they have this time built into their schedules so that they can work on their projects anywhere. It is the responsibility of the team to find additional time outside of the allotted lab time to work on their project. The team has both a Client and Project Director that they also report to throughout the year. Most groups hold regular weekly meetings to keep the flow of the project continuous. The Client helps the team to determine the scope of the project and makes sure that they are meeting all the requirements. The Project Director gives the team members advice and essentially employee-reviews. This person grades the students on their achievement and effort throughout the project. These performance reviews end up turning into the grades that the students receive in the class. There are suggested deadlines throughout the year with certain hard deadlines at the end of each semester (*i.e.*,

preliminary design review, critical design review, manufacturing review, final product, and final documents). It is the team's responsibility to spread out the workload and distribute it evenly throughout the year.

Although all of the senior capstone design classes ("morning meetings") were observed, this research followed one team very closely throughout the year. This team created a medical device that would help both doctors and researchers understand and analyze cardiovascular diseases and treatments. There were two clients for this specific project, one being an Associate Professor in Mechanical Engineering with a focus in Biomedical Engineering, and the second a cardiologist at a well-known hospital. The Project Director was also an Associate Professor in Mechanical Engineering who has an extensive background mentoring senior and graduate design teams. The end product for this project had to be meticulously designed, manufactured, and tested before the end of the year. The final product went to the client for them to use for their own future needs, and the students were even able to file for a preliminary patent on their design because of its novelty and helpfulness in the medical field.

### Analytical Framework

The design process is itself a complex cognitive process,<sup>1</sup> thus requiring an in-depth look at how this cognition evolves on a design team. This research project was approached with the methodology of cognitive ethnography, which examines how design projects are accomplished within their own organizational setting and functional system.<sup>17</sup> In particular, the team looked at the cognitive ecology that impacted the design teams. Cognitive ecology is referring to all the aspects that affect the design, including everything outside of the immediate team itself. Through mapping out all of these connections, as seen in Figure 2, a better understanding of the complexity of the design process is understood. Figure 2 gives an overview of how many internal and external factors can impact a design project. Although not all factors were listed, this list gives a general idea of the complexity of involvement on a design team. The design team itself is impacted by the team's motivation, knowledge level, conversations, decisions, compromises, and more. At the same time, there are external factors such as the client, mentor, resources, managers, and others that also heavily impact the design experience.

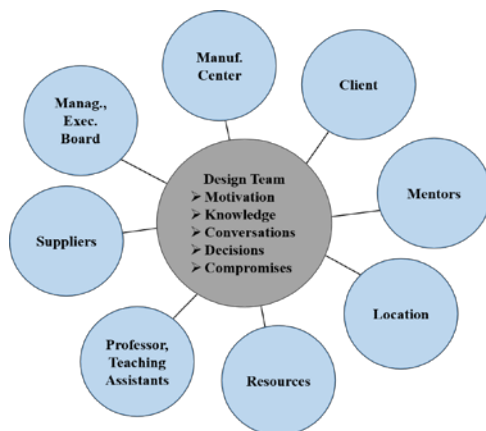

Figure 2. Expression of the cognitive ecology of a design team.

In the research observations, there was a strong focus on observing all heterogeneous elements, both human and nonhuman, which impacts the design process.<sup>10</sup> The negotiations, conversations,



and individual roles all play a large part in how design is constructed in each environment and how it is ultimately accomplished. Not only were conversations and interactions observed, but also all of the artifacts created or used to guide the process were used in the analysis.<sup>3</sup> This allowed the research team to understand motivations of all players in this cognitive ecology, from the immediate design team members to the executives and board members.

The methodological implication of this theoretical perspective on cognition is that the study of cognition cannot involve only the study of what is in individual heads, but must extend “beyond the skin”<sup>17</sup> to examine how individuals and groups of individuals use historically evolved artifacts in carrying out their activities. Similarly situated and distributed processes of cognition have been demonstrated in studies of the work in a wide range of professions, including that of scientists, mathematicians, and medical diagnosticians,<sup>18,19</sup> and hold promise for similar work in the study of engineering design.<sup>2,10</sup>

### **Research Methodology**

This qualitative research study was approached with techniques for doing fieldwork in modern societies.<sup>20</sup> A variety of fieldwork methods were used to capture all the elements of participants’ activities in the design process. These include both direct and indirect observational methods.

In direct methods, the researcher was in close proximity to the design teams and engaged in participant observations while taking field notes of the activities occurring.<sup>20</sup> The researcher would follow the team as often as possible and attend any formal and informal meetings. Additionally, both audio and video recording would complement the note taking. The audio helped to more crisply hear the conversations unfolding, while the video allowed the researchers to look at body movement and behaviors during meetings. Also, the research team collected materials and artifacts that were produced by participants during their work, including photocopies of paper documents; copies of electronic documents, such as pdfs and emails; and photographs of temporary surfaces like whiteboards that participants used while working.

In indirect observational methods, the researcher would ask participants to engage in prompted reflections on aspects of their activity, particularly insofar as it relates to the interests of this research. Also, the research team had the participants map out their daily and weekly schedules. These participants were asked to reconstruct a recent routine day in their school or work life by mapping their movement from place to place and describing their activities in each place. This allows researchers to possibly capture aspects of daily work that are less readily available to traditional interviewing practices.<sup>20</sup> Additionally, throughout the research, the team decided to expand these direct and indirect observations to all people and groups that have an impact on the design process and final product. These include, but are not limited to, the board in charge of cornerstone design; the faculty and employees who organize senior design; the employees of the machine shop; and the professors, clients, and employees of the university and engineering college. All of these people, places, and things are part of this “bigger” cognitive ecology that has evolved around the immediate design team.

During this research, over 200 hours were spent directly observing the design ecology and over 200 materials and artifacts were collected. All of these observations and artifacts were reviewed, preliminarily analyzed for themes, and then stored in a secure location. All of the observations

and collected materials were then compared side-by-side.<sup>21</sup> The data was critically analyzed from many angles, and then, all of the forms of data collection were checked against one another in the process known as triangulation.<sup>22</sup> Although many hypotheses have been unveiled from this work, it was chosen to discuss the idea of a disconnected trajectory between undergraduate design and professional engineering design, as this area could greatly benefit the ongoing efforts to restructure engineering education.

### Overall Findings

The overall findings in the research show disconnect between undergraduate design courses and professional design experiences, thus creating a disconnected trajectory from academia to industry. These findings can be broken down into eight different categories, as seen in Table 1. These categories make up both the outer and inner portions of the design trajectory discussed in Figure 1. They are design progression, design location, team formation, end product, approach to design, team demographic, motivation, and evaluation.

Table 1. Summarized findings comparing undergraduate design and professional design

	Undergraduate Design	Professional Design
<b>Design progression</b>	Disconnected courses	Linear subsequent projects
<b>Design location</b>	University	Company
<b>Team formation</b>	Social styles (cornerstone) or multi-step process based on interest, skills, preference, GPA (capstone)	Selected individuals whom bring select skills
<b>End product</b>	Often disposable (cornerstone) or client-driven product (capstone)	Often sold to the end user or client
<b>Approach to design</b>	Abstract technical representation, design loop	Complex non-linear process
<b>Team demographic</b>	All engineering, same majors (capstone)	Multi-disciplinary – not all engineers, many various
<b>Motivation</b>	Get a good grade, pass course, graduate	Get product to client, build business, advance self
<b>Evaluation</b>	Grades, design showcase awards, verbal assessment	Product success or failure, mid-and annual assessments

*Design Progression.* The organizational trajectory for design courses in academia ends with the course itself; there is usually no next phase for the project or continuation of the work into the next sequenced design course. This is much different than professional design companies, where one project impacts the direction of the next project and future role obtained. The trajectory is directly connected and the success or failure of a project will impact the engineer's future job and projects. These trajectories can be seen in Figure 3. In undergraduate engineering coursework, many technical courses are linked together sequentially throughout consecutive semesters. For example, it is common for a student to take a linear progression of mathematical courses starting with Calculus 1, followed by Calculus 2, then Calculus 3, next Linear Algebra, and lastly Differential Equations. This example is shown in Figure 3 as well. These sequential courses build upon one another conceptually, and students can smoothly transition from one course to the next throughout their degree. This sequence of courses is very common for the technical-based courses, but not for the design-based courses. Often times, students have the

opportunity to take a cornerstone engineering design course in their first year. This is a stand-alone course that ends with the semester and is used more for retention purposes than anything else.<sup>23</sup> It is common for students not to have another design-based course until senior capstone. This leaves a three-year gap between the first and last design course taken during undergraduate years. Some colleges have changed their curriculum to include more design course in the curriculum, but this is not a standard for all schools yet.<sup>24</sup> The University researched in this study used the model presented in Figure 3. Each design class has its own unique project that is started and finished within the course's timeframe. Once the class is done, there is no continuation with the project to the next design class by those same students. Therefore, there is a disconnected trajectory for the design courses in the undergraduate curriculum.

In professional engineering firms, often times projects are linked together consecutively over multiple years. This gives engineers on the team the chance to work on a long-term project that may have multiple segments and milestones along the way. An engineer's career builds off of their experiences, skills learned, and relationships made. It is common for an engineer to move positions almost yearly so that s/he can gain valuable skill sets in his/her early years at a company. From each new team, the engineer learns what they enjoy and whom they enjoy working with. Each of these experiences plays an important role in where the engineer moves next. Companies want to invest time and money in employees that are hard workers and get jobs done efficiently and effectively. By succeeding in a certain position, a person can set themselves up well for their next project.

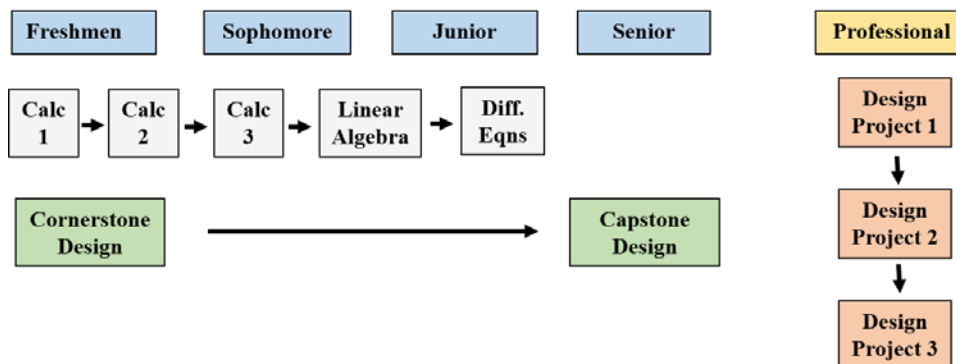

Figure. 3. The connected technical courses and disconnected design trajectories of undergraduate engineering students (left) and the connected trajectory of professional engineers working on design projects (right).

*Design Location.* Engineering design occurs in very different locations. In undergraduate courses, the work is usually restricted to either the classroom or the engineering building. Students are constantly changing the place where the work. Thus, they have to pack up all their belongings every time a meeting or working session ends. The students must reserve rooms and can only work during designated hours in the buildings that have resources they often need (*i.e.*, SolidWorks, MatLab, manufacturing center). Often times, it becomes difficult for students to find a room to work, a computer to use, or an expert (like those in the machine shop) to help them, due to the overall increase of students enrolled in engineering programs.

In professional engineering firms, the location of the design has the potential to rarely change. Employees have desks that are assigned to them and whole areas that can be designated for a project. Many team members sit in the same general area at work, thus making it much more likely for members to run into each other with the ability to have short conversations relating to their projects. Also, the team works approximately the same hours each day making it easier to schedule time for additional meetings, design reviews, manufacturing, and more. When the day of work or design meeting is done, the team can keep most of the belongings where they are or else move them almost minimally. This is a huge difference when compared to undergraduates whom do not have any place to call “home,” thus making these undergraduate teams essentially nomads in their design experience.

*Team Formation.* In undergraduate courses, teams are formed using a variety of factors including social styles assessments and pairing skill sets. In cornerstone design, social styles are the only deciding factor for who is placed on the team. Although the students are a variety of engineering majors, this is not a factor when placing the teams. In senior capstone design, the process is a little more complex. In order to divide the 165 students, first large piles are created by project interest, and then technical skills are used to separate members, followed by technical writing skills and leadership skills. Next the professor takes into account the formal requests from the students about whom they do not wish to work with on the project, and lastly the GPA is considered. Since all the students are in Mechanical Engineering, it means that this is the only background for all students on the capstone teams. In professional engineering companies, teams are chosen based on the skills needed and employees available. Often teams are formed for specific reasons based on a person’s knowledge-level or interest. Teams are also chosen based on the availability of employees. Because skills are the heart of the project, this makes for a much different demographic of team members.

*End Product.* The design products produced in undergraduate courses do not have a trajectory like those in professional projects. In many undergraduate design courses, products are disposed of or disassembled for reuse of parts in future project classes, and are not core aspects of the constitution of the organization. In cornerstone design, an actual dumpster was rented by the college for the week after the Design Expo so that students could dispose of the end products. In senior capstone design, the products can be more similar to industry in that they will be given to the client at the end of the term. However, many senior design company sponsors treat this as an experimental phase, or prototype, for a certain product and may not actually implement this into their system. It can also be thought of as a way to get their name out to more engineers. In contrast, at the professional level, trajectories are organized around these final products, and organizational and individual achievement is assessed on the basis of the success of these stabilized objects. Teams work hard to develop a product that they will then deliver to their user. A main component of the design process is making sure the final product is perfect and the client is happy, so that they will hopefully come back for more business. Companies are business-minded and end-results driven, whereas university courses are both learning minded and driven.

*Approach to Design.* At the undergraduate level, the process of design is constructed from abstract technical descriptions of professional design. Students are being taught regimented design methodologies, which gives them a false sense of the exact processes professional engineers use. In industry, engineers rarely use just a linear design methodology as a roadmap for

their projects. Instead, there is frequent commotion and multi-tasking occurring. If this professional “process” was to be mapped, it would appear as a tangled web of arrows pointing both forwards and backwards many times. Teams in industry do not sit down and follow the design loop that was taught in undergraduate courses, but instead do what needs to get done now based on prior experiences and knowledge. The approach to design is even more abstract in cornerstone design compared with capstone, although they both fall into this category. Cornerstone courses have the tendency to focus more heavily on conceptual design methods and less on discipline specific artifacts.<sup>1</sup> These first-year design students’ primary focus is on “finishing the design loop” in the semester and “throwing the final product together” if necessary. Students do not suffer in their grade if they do not develop a working prototype by the end of the class. Instead, they are rewarded for working on a team and completing all the steps on the design process. Additionally, cornerstone courses are meant to enhance students’ interest in engineering and contribute to the ongoing efforts to retain students in the engineering program.<sup>23</sup> Since the focus is mostly on getting students excited about engineering and retaining them into the program, this is not necessarily building a concrete foundation for their design skills. This mindset taught in cornerstone design translates into most students’ next design experience, which is often senior capstone design.

*Team Demographic.* The teams in undergraduate design courses are much different than those in industry. First off, each university team was comprised of all engineers. In senior design, the teams were made up of all Mechanical Engineering majors, once again narrowing the breadth of knowledge on the teams. Each student has almost identical backgrounds in regards to the courses taken in the last three years. Professional engineering companies are composed of a heterogeneous collection of disciplinary practitioners from engineering, management, marketing, and other distinct fields.

*Motivation.* As an undergraduate engineering student, the first priority is often passing courses and graduating. Students are motivated by grades; they see their GPA as the forerunner for getting them a job in the future. This motivation cannot be turned off for design courses, which creates a “get it done” mentality rather than one that challenges you to step out of your comfort zone and experience new things. Students rigorously follow the design process and course requirements, as that is how they have been trained to measure their success. Design is a much different type of class than other technical courses, and the current engineering curriculum still does not have a sufficient way to evaluate “good” and “bad” designs or client satisfaction other than through grading. In a company, employees are motivated by many other factors. Their role and actions on a design team can directly translate into a potential bonus, a promotion, recognition, and more. A professional engineer can pinpoint the next position they desire from their exploration of the company, and then work towards achieving that goal. They know that if they work hard that they will probably get a good recommendation and have a better chance at scoring their “dream job.”

*Evaluation.* The evaluation of engineers both in undergraduate courses and professional companies can be directly tied to the motivation. In undergraduate courses, students are evaluated based on how well they followed the “guidelines” throughout the course. Different factors are weighted as different percentages of their grade. Additionally, their teammates’ critiques play a role in how they are graded. In companies, engineers have a supervisor that they

directly report to. This person is responsible for their mid- and yearly- assessment as well as promoting them to another position or job within the company. Feedback is also considered from peers and others that they work with in their performance review. Since this feedback is usually aimed at improving you as an employee, it can be used as more motivation moving forward. It is the supervisor's job to help develop their engineers into an optimum employee with a diverse skill-set. Based on how well an engineer performs on a project, it will impact the next project and job that person has.

### **Key Findings & Conclusions**

The key findings from this research show that there is indeed a disconnected design trajectory between undergraduate engineering design courses and professional engineering design companies. The major reasons for this disconnection are related to how design progression occurs in each location and the team's approach to design for completing a project. However, there are even more subtle factors such as design location, team formation, end product, team demographic, motivation, and evaluation that all play a role in this disconnected trajectory of engineering design. As engineering education is the basis for providing students with the skills to become part of the professional engineering world, it is important that we truly understand what this "real world" is like. The findings from this project contributes to understanding the nature of the structure and practice of engineering design, and have direct relevance to ongoing attempts to redesign the engineering education curriculum in hopes to have a smooth trajectory from academia to industry.

### **Future Work**

Further work in this project includes observing more design teams in universities and companies, while also spending time observing the entire cognitive ecology of the teams. A large component of the future work will be an in-depth ethnographic study of professional engineering design companies so that more direct comparisons can be made between the different design entities. Additionally, the team will be studying technical-based classes with heavy design components, such as a junior-level course in the Mechanical Engineering department where students both learn about mechanical components and also design a drill-powered vehicle during the semester. All of the work will be analyzed using ethnographic methods such as observations, video and audio recording, multi-day shadowing, collection of all artifacts, and in-depth interviews. Through all of this work, we hope to achieve a better understanding of the practices of engineering design work both in academia and industry, as well as contribute to the ongoing attempts to reorganize the undergraduate engineering curriculum.

### **Acknowledgements**

This research was supported by the National Science Foundation (CMMI Grant No. 1355599).

### **Bibliography**

1. Dym, C.L., Agogino, A.M., Eris, Ozgur,E., Frey, D.D., & Leifer, L.J. (2005). Engineering design thinking, teaching, and learning. *Journal of Engineering Education*, 95(1), 103-120.
2. Ulrich, K. T. (2011). *Design: Creation of artifacts in society*. Karl T. Ulrich.
3. Bucciarelli, L.L. (1994). *Designing Engineers*. Cambridge MA: MIT.
4. Barley, S., and Orr, J. (1997). *Between craft and science: Technical work in US settings*. Ithaca: Cornell University Press, N.Y.
5. Stevens, R., Johri, A., and O'Connor, K. (2013). Professional engineering work. In B. Olds and A. Johri (Eds.), *Cambridge Handbook of Engineering Education Research*. New York: Cambridge University Press.

6. Trevelyan, J. (2010). Reconstructing engineering from practice. *Engineering Studies* 2, 3: 175–196.
7. Trevelyan, J. P., & Tilli, S. (2007). Published research on engineering work. *Journal of Professional Issues in Engineering Education and Practice*, 133(4), 300-307.
8. Vinck, D. (2003). *Everyday engineering: An ethnography of design and innovation*. Cambridge, MA: MIT
9. Faulkner, W. (2008). Nuts and Bolts and People. *Social Studies of Science*, 37(3), 331-356.
10. Suchman, L. (2000). Embodied Practices of Engineering Work. *Mind, Culture and Activity*, 7, 1-2, pp. 4-18.
11. Dutson, A. J., Todd, R. H., Magleby, S. P., & Sorensen, C. D. (1997). A Review of Literature on Teaching Engineering Design Through Project-Oriented Capstone Courses. *Journal of Engineering Education*, 86(1), 17-28.
12. National Academy of Engineering (2005). *Educating the Engineer of 2020: Adapting Engineering Education to the New Century*. Washington, DC: National Academies Press.
13. Hall, R. & Stevens, R. (1995). Making space: A Comparison of mathematical work at school and in professional design practice, *Cultures of Computing*, Susan Leigh Star (Ed.) London: Basil Blackwell.
14. Nguyen, D. Q. (1998). The essential skills and attributes of an engineer: A comparative study of academics, industry personnel and engineering students. *Global Journal of Engineering Education*, 2, 1, 65–76.
15. Orr, J. (1996). Talking about machines: An ethnography of a modern job. Cornell University Press, Ithaca, N.Y.
16. Knight, D., Sullivan, J., Louie, B. (2007). Expanding understanding of first-year engineering student retention and team effectiveness through social styles assessment. In *Proceedings of the ASEE Annual Conference and Exposition*.
17. Hutchins. (1995). *Cognition in the wild*. Cambridge MA: MIT.
18. Goodwin C (1995). Seeing in depth. *Social Studies of Science*, 25: 237-274.
19. Norman GR and Brooks LR (1997). The non-analytical basis of clinical reasoning. *Advances in Health Sciences Education* 2: 173-184.
20. Czarniawska, B. (2007). *Shadowing and other techniques for doing fieldwork in modern societies*. Copenhagen: Copenhagen Business School Press.
21. Maxwell, J. A. (2012). *Qualitative research design: An interactive approach* (Vol. 41). Sage Publications.
22. Fielding, N., & Fielding, J. L. (1986). *Linking data*. Beverly Hills, CA: Sage Publications.
23. Knight, D. W., Carlson, L. E., & Sullivan, J. (2007). Improving engineering student retention through hands-on, team based, first-year design projects. In *Proceedings of the International Conference on Research in Engineering Education*.
24. Kotys-Schwartz, D., Knight, D. and Pawlas, G. (June 2010). First-Year and Capstone Design Projects: Is the Bookend Curriculum Approach Effective for Skill Gain? In *Proceedings of the American Society for Engineering Education Annual Conference & Exposition*, Louisville, KY.

## **Student Engagement, Learning, and Retention in a Freshman, Large Class Setting at the University of Arizona**

Loukas Lazos and Elmer Grubbs  
University of Arizona

### **Abstract**

This paper describes a new approach to teaching a large lecture *C* Programming class (ECE175) in the Electrical and Computer Engineering Department at the University of Arizona. The approach demonstrates a method of increasing student engagement, student learning and student retention by using Undergraduate Laboratory Assistants (ULAs) in conjunction with Graduate Teaching Assistants (TAs) in a laboratory environment. The class typically has an enrollment of 175 to 230 students per semester and is a service course for students outside of the major, in addition to ECE majors. In the past, the class had an optional attendance laboratory component, staffed by several TA's, who offered homework assistance to students. In the revised course structure, the laboratory component has been transformed to a mandatory attendance recitation/activity/grading 3-hour lab, with 5 sections of up to 49 students each. The lab space is equipped with 49 workstations, all linked to a single computer controlled by the instructor. Each lab section is staffed by at least two TAs and 4 to 8 ULAs, depending on the lab enrollment. Prior to attending the lab, students submit their weekly homework assignment on the DesireToLearn (D2L) online submission system. Weekly homework consists of one to three programming problems related to the main lecture material and a series of multiple-choice, true/false, and short "human-compiled" code questions taken from the online interactive course textbook. In the lab, each individual student is graded by a ULA for a period of 15 minutes on his prior HW submission. Grading is based on a rubric designed to test a) the completeness, correctness, and code efficiency and b) the student's conceptual understanding on the code that he/she developed and related software engineering concepts. The lab also consists of one or two additional programming assignments, which must be completed within the remaining lab time. Initial experiences with the revised course structure indicate that the lab portion has improved student engagement, learning, and retention. Statistical analysis from the online textbook, which has a series of computer graded exercises, final grades, and number of drops per class are used to evaluate whether student learning and retention has been increased.

### **Introduction**

ECE175 is an introductory *C* programming course, which has been taught in the Electrical and Computer Engineering (ECE) Department at the University of Arizona for many years. It has always had enrollment from non-majors, but the last four years it has become a mandatory course for most College of Engineering students. As a result, the majority of enrollees are non-ECE majors. Enrollment has varied over the years from 30 to 40 students up to recent class sizes of 180 to 230 students per semester. It is taught twice a year in one lecture section and multiple laboratory sections per semester. The *C* language was originally chosen, not because it is necessarily the best, most useful language around, but because it serves as a good basic language, which allows students to rather easily transfer over to other languages as needed. It is also still highly useful in industry. The course used to be a traditional lecture course, using a standard text



on C Programming and another text on UNIX, where the lecture was used to go over programming concepts and work example problems for the students. Students were assigned homework problems, which were all programs. The class had no lab component, but TAs were assigned to hold extensive office hours in a computer lab to help the students with homework on an as needed basis. The lab was typically underused most of the semester, but became crowded at times just before the programs were due. There were two semester exams, and a final, team-based project. Most ECE majors seemed to do fairly well in the class, some with minimal TA interaction. As the class became larger, the TA interactions became somewhat problematic because of the number of students needing help right before the due date, as well as with academic integrity issues.

The instructors were faced with the problem of redesigning the class to enhance the student learning experience by increasing student engagement. Subsequently, it was decided to “flip the class<sup>1</sup>.” The idea was to make these changes in a way that would accommodate larger numbers of non-majors and to make the class more student-friendly. It was thought that this would increase retention, enhance student involvement, promote better understanding of the class material, and deter violations of the academic integrity policy.

The class was re-organized to use the lecture for explaining concepts, working problems by writing programs as well as using active learning techniques. A set of PowerPoint lectures were put on-line for the students to view as needed. An on-line book also was added and a non-Unix windows operating system using Visual Studio was introduced. A new three-hour per week mandatory laboratory was added, which was staffed by TAs and ULAs. This was held in an updated computer laboratory. These changes will be discussed in detail in the next section of the paper.

### **Basic Course Design**

The first part of the idea behind flipping a class is to provide out-of-class activities that are essentially equivalent to the lectures that are normally presented in a classroom setting. The students are instructed to review these lectures during the time they would normally be studying at home. The second part of flipping, which is in the classroom and lab, consists of going over concepts and working problems with the students, either on a chalkboard or a screen or individually with each student. In ECE175, a series of PowerPoint lectures were designed to be used by the students out of class. These lectures cover the material normally lectured on by the instructor in previous years. An on-line book from Zyante (see Figure 1) was also added to the class. In addition to the reading, the book contains exercises that are worked by the individual students outside of class to help them understand the material covered by the book and in lectures. The book software keeps track of the students’ progress on a set of interactive exercises listed at the end of each section and of the number of each student’s attempts until an exercise is correctly completed. We use the results of these exercises to give a participation grade to the students. In addition to the online book, the course has a main website where the syllabus, lectures, etc. are stored (see Figure 2) and an enhanced discussion board website called Piazza (see Figure 3) that implements a class discussion forum between students, instructors, TAs, and ULAs.

Programming in C | University of Arizona

Welcome, Elmer Grubbs  
Portal | Account | Help | Logout

## Welcome

Web-native learning: Less text, more action.

- 1 New user? Subscribe  
Subscribed? Login above
- 2 Read, run animations and interactive tools,  
do question sets
- 3 View your activity in your  
Portal

- Best viewed with Chrome, Safari, Firefox, and Internet Explorer (ver. 9 and later).
- Click chart icon in chapter menu: Green borders will surround completed activities, else yellow borders.
- Activities only recorded when *logged in* and connected to Internet.

grubbs@email.arizona.edu's activity data		
Chapters/sections/activity titles	%Attempted activities (attempted/total)	%Correctly answered questions (correct/total)
Chapter 1: Introduction	0% (0/40)	0% (0/29)
Chapter 2: Variables	0% (0/114)	0% (0/104)
Chapter 3: Branching	0% (0/65)	0% (0/57)
Chapter 4: Loops	0% (0/85)	0% (0/48)
Chapter 5: Functions	0% (0/107)	0% (0/93)
Chapter 6: Arrays	0% (0/66)	0% (0/56)
Chapter 7: Structs	0% (0/28)	0% (0/22)
Chapter 8: Pointers	0% (0/43)	0% (0/32)
Chapter 9: File/I/O	0% (0/25)	0% (0/23)
Chapter 10: Recursion	0% (0/26)	0% (0/19)

Legal - Contact Us - Copyright © 2013 Zyante, Inc.

Figure 1. The Zyante online interactive book website.

Department Of Electrical And Computer Engineering | University Of Arizona

Home | Syllabus | Lectures | Assignments | Grading | Resources

## ECE 175: Computer Programming For Engineering Applications

### News

Please register at piazza.com for online discussions and questions

Go to m.socrative.com room 247694 for in class exercises

You must have a laptop, tablet or smart phone with a browser for this class

### Time and Location

Tuesdays & Thursdays: 12:30 PM - 1:45 PM Aerospace and Mechanical Engineering, Rm. S202

### Instructor

Figure 2. The course website.

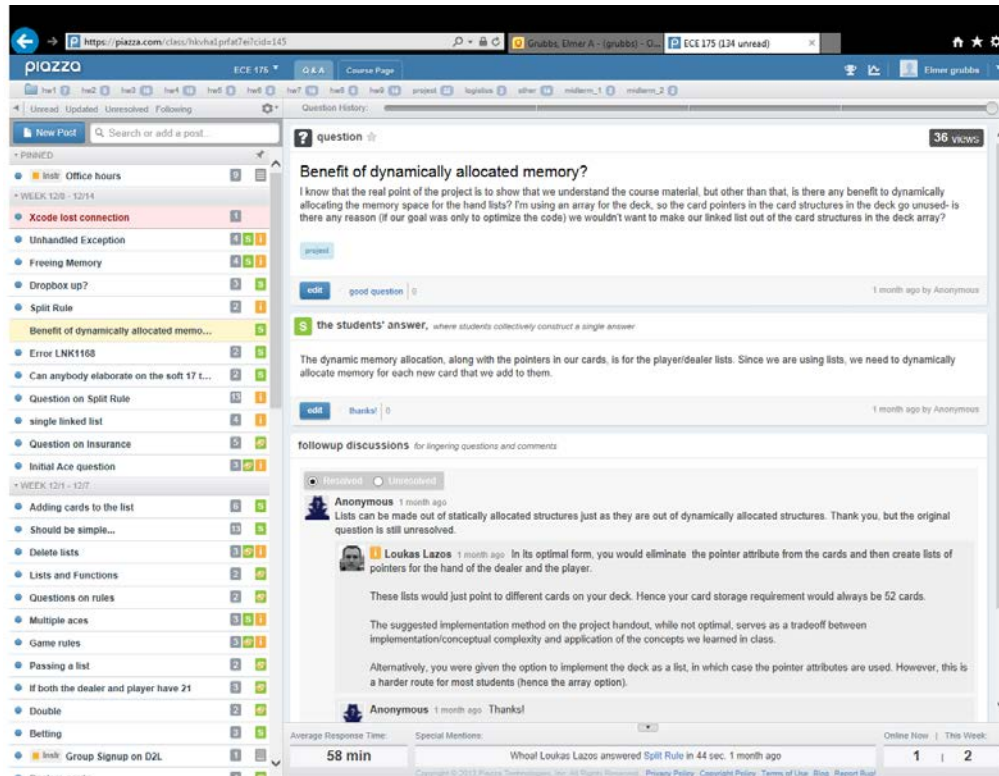

Figure 3. The Piazza website.

Besides the traditional in-class lecture, the class consists of multiple laboratory sections of up to 49 students each. Each session is staffed by at least two TAs and four to eight ULAs. The TAs are graduate ECE students and the ULAs are undergraduate ECE students who have previously taken the class and excelled. These sessions take place in a computer lab with fifty workstations, all networked with the instructor's computer at the front of the room. The lab sections run from Wednesday of each week through Friday. There are typically five sections.

Homework is assigned every Tuesday and is due the following Tuesday by midnight. Prior to attending the lab, students submit their weekly homework assignment on the DesireToLearn (D2L) online submission system. Weekly homework consists of one to three programming problems related to the main lecture material and a series of multiple-choice, true/false, and short "human-compiled" code questions taken from the online interactive course textbook. In the lab, each individual student is graded by a ULA for a period of 15 minutes on his prior HW submission. Grading is based on a rubric designed to test a) the completeness, correctness, and code efficiency and b) the student's conceptual understanding on the code that he/she developed and related software engineering concepts. The rubric, in addition to correct answers, contains specific questions to ensure that understanding of the presented solution. A sample homework problem and its corresponding rubric are shown in Figures 4 and 5, respectively. A sample question set problem from the interactive course textbook is shown in Figure 6. Figure 7 shows a copy of the group project from last year. The appendix contains a copy of the syllabus.

The lab also consists of one or two additional programming assignments, which must be completed within the remaining lab time. Students work on the in-lab assignments with the

assistance of the TAs and ULAs for the remaining lab period. The problems are different for each lab section per week. When a student completes a problem, the ULA comes over to them and grades the problem for them. They must finish prior to the end of the lab period. The students are able to work together on these problems and it is not unusual for some students to finish early and then help the other students to finish the problems. So the lab is really a hands-on work session with peer-learning experiences built-in. We believe this laboratory helps the students out by engaging them more in the process than the typical lab experience might accomplish.

Question Set 4.1.2: While loop iterations.

What will the following code output?(For an infinite loop, type "IL")

Num	Question	Your Answer	Hint/Explanation	Show
1	<pre>int x = 0; while (x &gt; 0) {     printf("%d", x);     x = x - 1; } printf("Bye");</pre>	<input type="text"/> <a href="#">Check</a>	✘	<a href="#">Show</a>
2	<pre>int x=5, y=18; while (y &gt;= x) {     printf("%d", y);     y = y - x; }</pre>	<input type="text"/> <a href="#">Check</a>	✘	<a href="#">Show</a>
3	<pre>int z=0; char c = 'y'; while (c = 'y') {     printf("%d", z);     scanf("%c", &amp;c);     z = z + 1; }</pre>	<input type="text"/> <a href="#">Check</a>	✘	<a href="#">Show</a>
4	<pre>int x = 10; while (x != 3) {     printf("%d", x);     x = x / 2; }</pre>	<input type="text"/> <a href="#">Check</a>	✘	<a href="#">Show</a>

[Feedback](#)

Figure 6. Online book question set

## Results

The objectives of the course redesign were:

1. To increase student learning
2. To enhance student involvement
3. To increase retention
4. To ensure students were doing their own work and fully understand their solutions

The goals of enhancing student involvement and making sure that students were doing their own work were accomplished directly by the changes in the class structure. Obviously the students are more involved in the lab since attendance is mandatory, making sure that they work directly with TAs, ULAs and their peers, and assigning a significant portion (60%) of their overall grade to the lab component. The individual oral grading of the students' homework and lab work, using

the professor-supplied rubric, helps to ensure that each student, at the least, understands the work that he/she turned in and has a good understanding of the fundamental concepts. Moreover, during the oral examination, the ULAs offer additional *individual* explanations and demonstrations to cover students' conceptual and technical deficiencies.

### *Final Project ECE175 Spring 2013*

The final project is to write a c program to simulate the card game called "War". The rules are:

1. You are to play with a deck of 52 cards, ranking from low to high as follows: two, three, ...ten, jack, queen, king and ace. There are 4 suits (H S D C) of each numbered and face cards, although for the game, suits are ignored. The deck needs to be shuffled, then deal 26 cards to each of two players (This is called a hand).
2. Each player places the top card face up on the table and the player with the higher card takes the two cards and places it in his discount pile (he wins the first round of the game). If the two cards are identical, each player places three cards face down on top of their first card, then one more card face up on top of their pile. Again, the highest card takes the entire two hands. This is called a war.
3. Each player when he or she runs out of cards, then uses the discount pile to form a new hand to play the game from. The cards are not reshuffled when going from the discount pile to a hand.
4. The first player to totally run out of cards loses the game. If you run out in the middle of a war, you still lose.
5. Shuffle the cards using the rand[] function.
6. Represent your hand as a linked list of cards typedef struct card\_s {  
Use a typedef struct to define the cards.char suit; int face; struct card\_s \*listp; } card;
7. At the beginning of each round, you must display the top card for each person, indicate whether there is a war on not, and display the total number of cards still in each person's possession. Upon entering a return key, the game will play the next round. The program should announce the winner at the end of the game.
8. The display should look like the following:

```

*****
*   *
* 8 *
*   *
*****
*****
*   *
* J *
*   *
*****

```

```

No War           20 cards           32 cards
Next Round

```

Honor code: You are expected to submit your own code. You may ask others for advice, and in general discuss the project, but you should WRITE YOUR OWN CODE. If any part of the code submitted by different teams is identical, ALL involved parties will receive 0 credit on the project and one letter reduction in their final grade. The project is to be worked in teams of two students each, and you should use modular programming, documentation, etc.

Increased retention can be measured by computing the student percentage that drops the class and comparing it with data from class offerings prior to the implemented changes. Student learning can be measured by comparing the percentages of students in each grade category with previous ECE175 class statistics. Refer to Figure 7 for a chart of these comparisons. Note that the number of students scoring 80% or above went from an average of 51.5% to 68.4%, an increase of almost 17%. The percentage of students who dropped the class decreased modestly from an average of 5.4% to 4.4%, and the percentage of students failing the class dropped from an average of 11.5% to 7.3%. We are also attempting to increase student learning by adding some video format learning activities for the students to do outside of class, which cover difficult topics in the class. The evaluation of these goals will be covered in the next section.

### **Future Work**

The University of Arizona currently has an AAU STEM<sup>3</sup> (Association of American Universities Science, Technology, Engineering and Mathematics) initiative project, which this class is a part of. Our role in the overall project is to improve student learning and retention by identifying difficult topics and producing a series of video demonstrations to address these topics. Another set of videos will be used to show how expert programmers solve typical programming problems. These solutions will include program design, algorithm design, debugging, etc. The students will view these videos as needed outside of the classroom environment. We are proposing to measure the success of these videos by using problems from the online book in a before and after fashion. We will assign half of the problems on a particular topic first and measure success based on successful answers, number of attempts, etc. Then we will have them view the videos and assign the second half of the problems. By comparing the success rate and number of attempts statistics before and after the video showing, we will obtain a measure of how well the videos are working. We will be doing these measurements during the Spring and Fall 2014 semesters.

### **Conclusions**

We have described a novel approach for teaching a large introductory programming class at the University of Arizona, which involves flipping the classroom and providing systematic TAs and ULAs assistance in a laboratory setting to increase student involvement in the educational process. We have shown that the techniques described here have increased student learning, retention, and engagement. We have also briefly described future steps for further improving student learning, which we are implementing in the next several semesters.

### **Bibliography**

1. Noonoo, Stephen, "Flipped Learning Founders Set the Record Straight," *T.H.E Journal*, 20 June 2012, <http://thejournal.com/articles/2012/06/20/flipped-learning-founders-q-and-a.aspx>.
2. D2L, Desire2Learn website, <http://d2l.arizona.edu>
3. AAU STEM initiative website <http://www.aau.edu/policy/article.aspx?id=12588>

## **Machine Vision, PLCs and Motion Control for Manufacturing Engineering Undergraduate Students**

Jose Macedo and Nick Sweeney  
California State Polytechnic University, San Luis Obispo

### **Abstract**

A sequence of two 10-week courses on advanced industrial automation were designed and implemented in 2013 with support from various industry partners. The courses, including laboratory, were designed for upper division undergraduate engineering students, and were offered for the first time in Spring and Fall 2013. The objective was to provide engineering students with theoretical and hands-on practical experience with automation technologies that are of prime importance in industry: machine vision, programmable logic controllers based on the IEC-61131 standard, motion control and the integration of these technologies. Developing applications and integration of state of the art industrial automation technology (hardware and software) has become fairly easy compared to only a few years ago. Manufacturing engineering students, as well as all other engineering students who will work on design and improvement of automated processes should be exposed to these advanced automation technologies. This paper describes the methodologies and relevant concepts covered in class, laboratory equipment, and lab activities developed for this course, as well as examples of student projects from Fall 2013. The course and laboratory materials were evaluated for learning effectiveness and technical content, which are included in this paper.

### **Introduction**

During the past ten years, manufacturing automation has changed dramatically. Developments in software and new standards allow rapid development and integration of sophisticated automation applications. It is possible now to develop applications that require integration of machine vision, programmable logic controllers, control of multi-axis servomotors, and robot manipulators from multiple vendors in a fairly short amount of time. It has become an accepted technology with many successful industrial applications. These changes have occurred due to several factors: the growth in computing processor power and speed, growth in memory capacity, significant cost reduction of computer and machine vision technologies, the availability of powerful and easy-to-use PLC, machine vision and motion control software tools, and the development of industry standards such as the IEC 61131.

There is much interest in industry to recruit talented engineers with knowledge of automation of products and processes. It is important to distinguish the difference between engineers who may work in automation of products, known as mechatronics or embedded computers, and engineers who may work on automation of processes, known as factory automation. There are similarities in the body of knowledge for both of these automation engineers, and both are very much in demand. The difference between engineers who work in automation of products (mechatronics) and automation of processes, becomes evident when we look into the development cost, number of copies into which the automation will be implemented and cost per unit. When developing an automated product, for example a refrigerator that is “internet ready”, the cost of development

and cost of hardware will be prorated among many thousand copies of the product, so the cost per unit will be small enough to be attractive to consumers and competitive. When developing an automated process or production line, it is likely that there will be one or very few production lines, but what is important is that the development of the automated system is completed in a short time, is robust, reliable, safe, easy to integrate to existing networks, easy to repair, and easy to modify. This paper is concerned with developing a sequence of two courses and laboratory experiences to prepare engineering students for the automation of processes and production lines.

### **Details of the Courses**

These two courses are IME 356 Manufacturing Automation, and IME 416 Automation of Industrial Systems. Both courses include three-hours of lecture per week and a three-hour laboratory experience per week. These courses cover use of computers in factory automation, basic control theory including feedback, programming and use of programmable logic controllers (PLC), human-machine interface (HMI), number systems, digital inputs/outputs, analog inputs/outputs, A/D and D/A conversion, sensors, actuators, IEC 61131 standard, ladder logic, Boolean algebra, state transition diagrams, timers, counters, math instructions, logic functions, sequencer instructions, automation safety, fail safe concept, pneumatic actuators, solenoid valves, motion control, stepper motors, servo motors, encoders, machine vision, CNC motion control, robotics, automation networks, and integration of systems. The emphasis on the second course is on machine vision, two-axis servomotor control, and integration of systems.

The cumulative objectives for these two courses are that by the end of this sequence, students should be able to:

- Be able to identify relevant variables in the design of automated systems
- Be able to describe the components of an automated system, their functions, and the various technological options available for them.
- Be able to select the components suitable for an automation application
- Be able to design and integrate automation into a manufacturing system
- Be familiar with programming a PLC using ladder logic or other IEC 61131 languages.
- Be able to identify situations or systems which could be improved by the application of automation.
- Be able to identify and select the automation components that are suitable for an intended application.
- Be able to design or integrate automation into a manufacturing system.
- Be familiar with automation safety terminology, technology, and its application.
- Be able to do an economic justification for an automated system.
- Be able to describe the components of a machine vision systems, their functions, and the various technological options available for them.
- Be familiar with the most common image processing algorithms used in industrial applications.
- Be able to identify situations or systems that could be improved by the application of machine vision.
- Be able to identify and select the machine vision components suitable for an intended application.
- Be able to design or integrate machine vision into a manufacturing automation system.
- Be able to describe the components of servomotor systems, their functions, and the various technological options available for them, including multi-axis servos, stepper motors.
- Be familiar with servomotor functions and algorithms used in industrial applications, such as: electronic gearing, camming, and servo-tuning.
- Be able to identify situations or systems that could be improved by the application of servo-motors, and identify situations in when stepper motor control is adequate.
- Be able to identify and select the motion control components suitable for an intended application.



- Be able to design or integrate stepper motors and servo motors into a manufacturing automation system.

These courses are offered within a quarter systems. Therefore, each course includes 10-weeks of lecture and laboratory. During the first six weeks of the session, students learn how to use the equipment in the laboratory, following prescribed lab activities which include challenge exercises. During the last four weeks of the session, students work on projects, to be described later in this paper.

### Details of the Laboratory

There are 12 workstations in the laboratory, which can accommodate up to 24 students working in teams of two students per workstation. We have at least twelve copies of all the equipment available in the laboratory. Figures 1 and 2 show views of the automation laboratory.

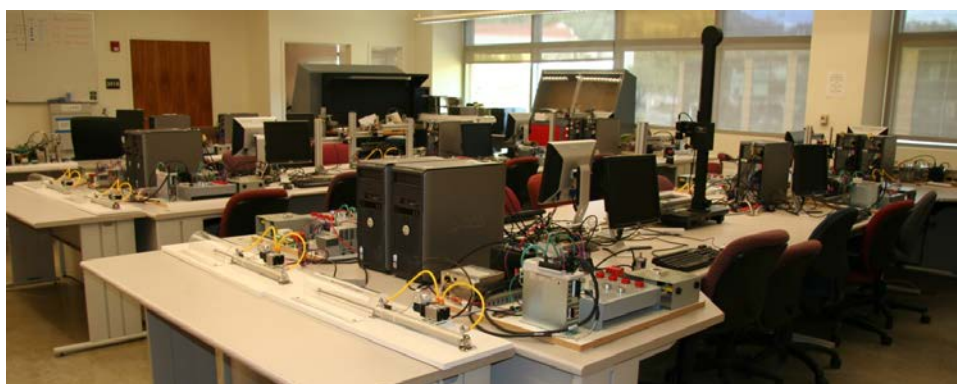

Figure 1. Gene Haas Laboratory for robotics and automation.

The equipment available in the laboratory includes twelve setups of the following:

- (1) Rockwell Automation, CompactLogix 5000 PLC, RSLogix 5000 Software, add-on modules for A/D, D/A, high-speed counter, and one-axis stepper motor controller, Kinetics 350 one-axis servomotor controller, FactoryTalk View software for HMI. See Figures 2 and 4.
- (2) Yaskawa America, MPiec two-axis servomotor controller, drivers, and two Sigma-5 servomotors, MotionWorks IEC software, and I/O trainer built at Cal Poly. See Figure 3.

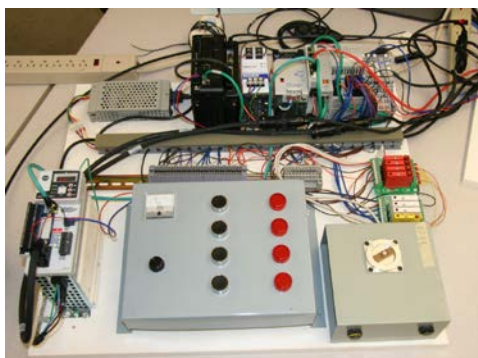

Figure 2. Rockwell Automation (Allen Bradley) CompactLogix PLC trainer.



Figure 3. Yaskawa 2-Axis servo-motor control trainer.

(3) Keyence, XG-7000 Machine Vision Systems and color cameras. See Figures 4 and 5.

(4) AMCI 3401 Stepper Motor Controller. See Figure 4.

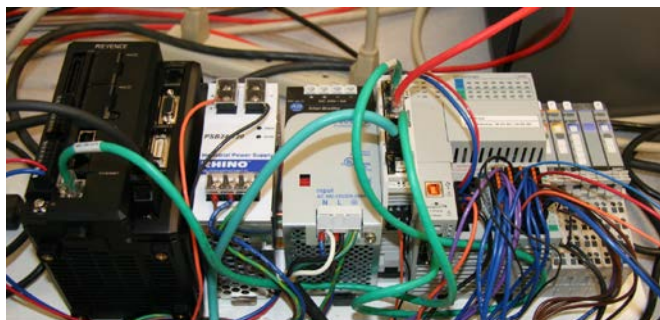

Figure 4. Keyence machine vision controller and CompactLogix PLC.



Figure 5. Keyence cameras for machine vision system.

(5) Pneumatic Cylinder Trainer, Built at Cal Poly with SMC components. See Figure 6.

(6) Linear Slides with Servomotor Control, Built at Cal Poly using Anaheim Automation components and Allen-Bradley Kinetix, built at Cal Poly. See Figure 7.

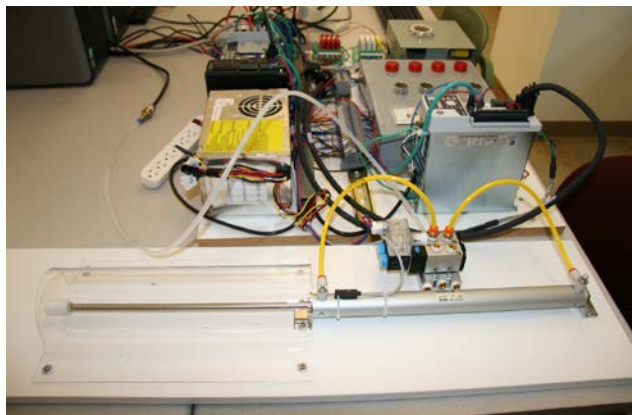

Figure 6. Pneumatic cylinder control trainer setup.

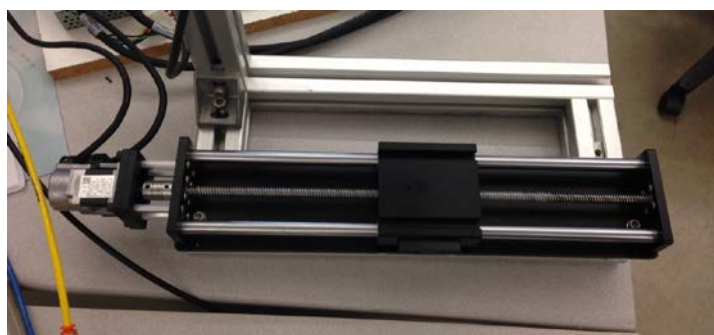

Figure 7. Linear slide with Rockwell Automation Kinetix servo-motor.

### Student Projects

Students were asked to develop a project in which they were expected to apply concepts learned in this class. All projects were self-selected. Students were encouraged to generate their own ideas for a project and to discuss these ideas with the instructors. There are some benefits as well as potential difficulties of this approach which instructors should be aware. The biggest benefit of self-selected projects is the high level of enthusiasm and motivation of the students once they start working on their project ideas. Students want to make their project idea work and will come to the lab more frequently to ensure the success of their project, very much like graduate students. A potential difficulty is that students unfamiliar with the technology may find it difficult to select a project idea. If the indecision is carried too far into the term, there may not be adequate time to develop or complete a quality project. Providing examples of project ideas, especially past projects for the same class, allows students to more easily move forward.

Students were asked make a brief informal presentation in class at the end of the quarter and to prepare a video about their project. The presentations were useful to all students as examples of other applications, methods used, problems encountered, lessons learned, and to discuss possible future enhancements of the projects. The videos have been useful to show past projects to the next cohort of students, as well as to visitors in general. The next few pages describe briefly the project topics developed by students in the last two offerings. A cumulative 32 students developed 16 projects. All the projects were successful in meeting their initial objectives, and in many cases, the projects were enhanced with additional features. Summaries of the student projects follow.

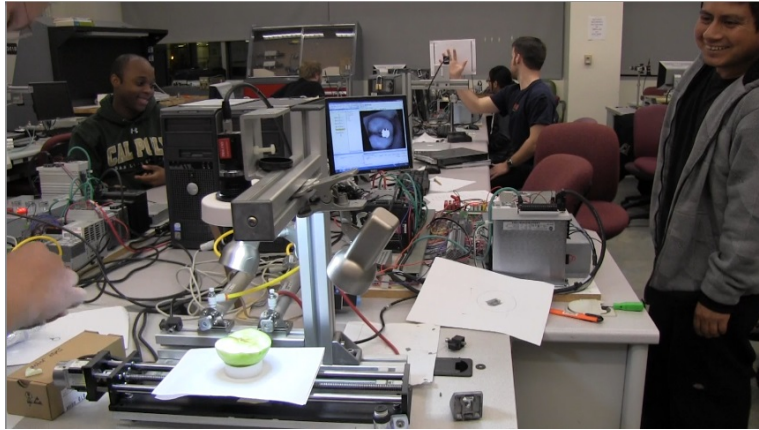

Figure 8. Student project - Inspection of sliced apples to detect if they have seeds.

Figure 8 shows a project developed to inspect sliced apples to detect if they have seeds or not. The machine vision system was programmed to analyze the image and determine if the apples had seeds or not. If the apples had seeds, they would be moved by the servo motor and slide mechanism in front of a pneumatic cylinder to be rejected.

Figures 9 and 10 show a project developed to copy any image presented to the camera on the vision system. The image was “sliced” into eight increments, and their boundaries of each segment were found, and their coordinates were sent to an X-Y table controlled by the two-axis servomotor system. The motion of the X-Y table was synchronized with a pneumatic cylinder which would lift and drop a pen to trace and replicate the drawing of the image.

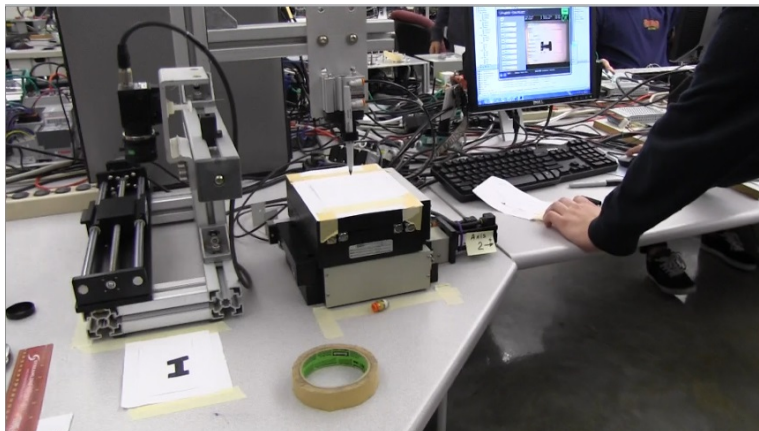

Figure 9. Student project – Copy machine to reproduce an image.

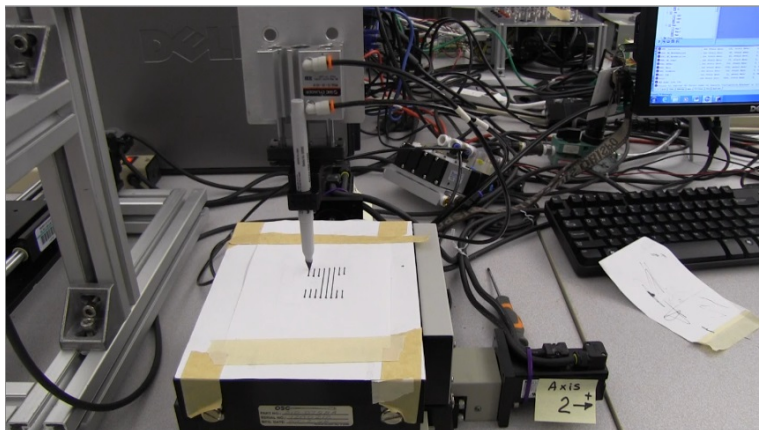

Figure 10. Student project – Copy machine to reproduce an image.

Figures 11 and 12 show a student project to detect five fingers in a human hand using machine vision, and when all five fingers are detected, it directs a servomotor to move a cardboard hand to give a “high five”.



Figure 11. Student project – High five machine.



Figure 12. Student project – High five machine.

All of these projects required students to develop programs for the PLC, the machine vision controller, and the servomotor controller, and integrate these programs into one functional

system. What is remarkable about all of these projects is that they were all developed during the last 3 to 4 weeks of the quarter, which is the way this classes and labs are designed.

### **Evaluation of Learning Objectives**

Both courses offered in this laboratory were well received by students. We are in the process of developing instruments to assess the effectiveness of this lab in meeting the learning objectives. We are also working on improvements to the lab modules and instructions to students with the idea of developing a laboratory manual. Some of the anonymous comments made by students in IME 416 in Fall 2013 were: “Great class”, “Very interesting class pertaining to automation technology used in industry”, “I am very glad that Dr. Macedo was flexible enough to open the lab for us and help us at all times”, “The documents and tutorial videos were great”, and “I was able to learn on the latest automation equipment”.

### **Conclusions**

Developing and integrating industrial automation applications has become fairly easy due to availability of new industry standards and software tools. Manufacturing engineering students, as well as all other engineering students who will work on design and improvement of automated processes should be exposed to advanced automation technologies. This paper describes effective methodologies, laboratory equipment, and lab activities developed for a two-course sequence on manufacturing automation at Cal Poly, as well as examples of student projects from Fall 2013.

### **Acknowledgments**

The development of the Gene Haas Laboratory for Robotics and Automation was made possible by generous grants and equipment donations from: The Gene Haas Foundation, Rockwell Automation, Yaskawa America, and Keyence.

### **Bibliography**

1. Ferrater-Simón, Coia, et al, “A Remote Laboratory Platform for Electrical Drive Control Using Programmable Logic Controllers”, IEEE Transactions on Education, Vol. 52, No. 3, August 2009, p.425.
2. Ljungkrantz, Oscar, et al, “Formal Specification and Verification of Industrial Control Logic Components”, IEEE Transactions on Automation Science and Engineering, Vol. 7, No. 3, July 2010, p. 538.
3. Macedo, Jose, et al, “Machine Vision Course for Manufacturing Engineering Undergraduate Students”, Journal of Manufacturing Systems, SME, Vol. 24, No. 3, 2005, p.256

## Research and Practice Group Methodology: A Case Study in Student Success

Christopher McComb and Fariborz Tehrani  
Carnegie Mellon University/ California State University, Fresno

### Abstract

Experiential learning is a key component in engineering education. In civil engineering, this component is typically delivered through multiple projects. These projects may include term projects for individual courses, senior design projects, theses, or independent studies. The focus of these experiences may gradually shift from practice-oriented projects in undergraduate studies to research-oriented projects in graduate studies. Thus, learning objectives should always address both areas with a strong emphasis on common fields, such as applied research. Experiential learning has the capacity to include various program-level outcomes, such as technical knowledge, communication and teamwork. Development of a research and practice group facilitates these outcomes by creating an environment to share the learning experience. Such a group should replicate the working environment of civil engineers by incorporating multidisciplinary projects and diverse individuals, including cross-generational members. As a case study, this work examines a Research and Practice Group at California State University Fresno. This group consists of junior and senior undergraduates, graduate students, and former members who are participating as alumni. The major focus of research within the group is resilient and sustainable structural mechanics and design. This paper outlines the methodology that has been employed to ensure academic and professional success for members of the group. This methodology incorporates a recruitment process, meetings, consultation, mentorship, networking, and support. The level of student success achieved by the group is presented in terms of the achievements of the group's members. This includes a discussion of completed projects, research funding, and group presentations. To further demonstrate the efficacy of the methodology, students in the research group are compared to the general body of engineering students at CSU Fresno through the results of a survey. This survey is analyzed using traditional methods, as well as Latent Semantic Analysis. Our results indicate that group members are better at embodying and communicating outcomes than the rest of the student body, and that the research and practice group provides an experience that allows students to internalize and take responsibility for their own goals.

### Introduction

Experiential learning is a key component in engineering education. The ASCE Body of Knowledge (BOK) considers professional experience to be a required supplement to bachelor and master degrees<sup>1</sup>. The requisite pre-licensure experience is expected to directly fulfill the highest level of achievement for most technical and all professional outcomes (see Table 1). Further, hands-on experience facilitates the achievement of foundational outcomes (mathematics and science), as well other areas of technical outcomes (for example, material science and mechanics). Thus, experiential learning does not necessarily have to begin after graduation. Rather, it should be incorporated in engineering programs throughout both undergraduate and graduate curricula.

Table 1. The BOK outcomes with respect to experience<sup>1</sup>

<b>Technical</b>	<b>Professional</b>
<b>Design</b> <b>Sustainability</b> <b>Contemporary issues</b> <b>Risk and uncertainty</b> <b>Project management</b> <b>Technical specialization</b>	<b>Communication</b> <b>Public Policy</b> <b>Business and public administration,</b> <b>Globalization</b> <b>Leadership</b> <b>Teamwork</b> <b>Attitudes</b> <b>Lifelong learning</b> <b>Professional and ethical responsibility</b>

In civil engineering, experiential learning is typically delivered through multiple projects that form the culminating experience for completion of a course or degree. These projects may include term projects for individual courses, senior design projects, theses, or independent studies. Many undergraduate design courses are often accompanied with term projects. For example, a course in design of steel structures may require a culminating design project. The purpose of such projects is to enable students to apply engineering knowledge and skills to solve relevant engineering problems. In this regard, students are expected to follow specific standards and procedures. This expectation shifts to another level of achievement in a senior design or capstone project, where problems are more complex and require more rigorous decision making as well as communication within a team. Further, the nature of a senior design projects typically introduces aspects of design that are new to students, such as risk, uncertainty, and project management. A capstone project is generally the most complex experiential assignment in a bachelor degree program.

Comparison of bachelor and master degree curricula shows that the focus of these experiences may gradually shift from practice-oriented projects in undergraduate studies to research-oriented projects in graduate studies. A bachelor thesis, an option provided in many engineering schools, serves as a smooth transition from practice-based projects to research-based projects. A graduate research project fulfills highest level of curriculum achievement for multiple technical outcomes, including experiments, problem recognition and solving, and technical specialization. Thus, the learning objectives should always address both areas of research and practice, with strong emphasis on common fields, such as applied research.

Experiential learning has the capacity to include various program-level outcomes, such as technical knowledge, communication and teamwork. Table 2 lists ABET (2010) and ASCE (2008) learning outcomes that are fulfilled through research projects. The levels of achievement cover a range of activities from which students may obtain knowledge; these are comprehension, application, analysis, synthesis, and finally evaluation.



Table 2. Mapping course learning outcomes to engineering outcomes<sup>1,3</sup>

<b>Engineering Outcomes (ABET, 2010)</b>	<b>Civil Engineering Outcomes (ASCE, 2008)</b>	<b>Experiential Learning</b>
(a) Mathematics, science, engineering	1. Mathematics 2. Natural sciences 3. Materials science 6. Mechanics 14. Breadth in civil engineering areas 15. technical specialization	Application
	3. Humanities 4. Social sciences	Application
(b) Experiments	7. Experiments	Synthesis
(c) Design	9. Design	Evaluation
	10. Sustainability 12. Risk / uncertainty	Analysis
(d) Multidisciplinary teams	21. Teamwork 20. Leadership 22. Attitudes	Analysis
(e) Engineering problems	8. Problem recognition and solving	Analysis
(f) Professional and ethical responsibility	24. Professional and ethical responsibility	Evaluation
(g) Communication	16. Communication	Synthesis
(h) Impact of engineering	11. Contemporary issues and historical perspectives 19. Globalization	Analysis
(i) Lifelong learning	23. Lifelong learning	Synthesis
(j) Contemporary issues	11. Contemporary issues and historical perspectives 19. Globalization	Analysis
(k) Engineering tools	8. Problem recognition and solving	Analysis
	13. Project management	Analysis
	17. Public policy 18. Business and public administration	Application

Further, the characteristics of independent studies, research projects and thesis fit the highest level of student development in situational teaching model as shown in Figure 1<sup>4</sup>. In this model, students begin their journey in an engineering program by obtaining direct guidance in early introductory courses (for example, a course introducing the engineering discipline). Later, they will receive essential knowledge in basic engineering courses, such a structural mechanics or dynamics. During senior year, students gain confidence to apply the knowledge of engineering in

design courses (for an example, a course in design of steel structures). Finally, a senior project allows students to be responsible-in-charge<sup>2</sup>.

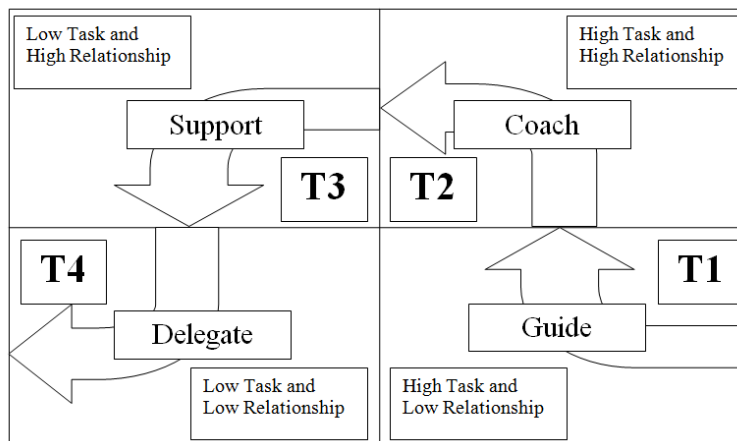

Figure 3. Situational leadership, after Hersey et al. (1982).

### Objectives and Purpose

Research groups have long been a key component of the university environment. Such groups are typically composed of supervising faculty members and graduate students at the masters or doctoral levels. The primary purpose of these groups is to support research and, to a lesser degree, teaching activities. However, we characterize the group studied in this work as a Research *and* Practice Group. This distinction is made to emphasize the fact that this group also supports activities that prepare students to practice engineering. In this way, the group also ensures student success by building upon the tenets of the Relational Leadership Model<sup>5</sup>: purpose, inclusion, empowerment, ethics, and process.

Further, the development of a research and practice group facilitates learning outcomes of engineering education by creating an environment in which the learning experience can be shared. Abbas, Alhammadi, and Romagnoli (2009) considered the notion of facilitating, rather than teaching, in development of a senior elective course within an engineering curriculum. The project-based course yielded positive learning outcomes, including teamwork and communication. Further, the course promoted ownership of learning and research, individual accountability, and personal responsibility, as key attributes of the transition from student to engineer. Lack of these attributes in engineering graduates prevents them from taking charge of large-scale projects<sup>9</sup>. Industry often requires their employee to attend project-based internship programs to fill this gap. In this regard, a research and practice group can effectively replicate the working environment of civil engineers by incorporating multidisciplinary projects and diverse individuals, including cross-generational members.

Duarte et al. (2012) took a more bottom-up approach to enhance engineering education. In this approach, research groups were formed as student-led initiatives. Ph.D. students provided leadership, and recruited undergraduate students. The report shows that the sense of belonging and ownership in these groups facilitated acquiring personal and professional competencies. Further, the student-led characteristic of these extracurricular groups helped the faculty to manage the time-consuming training of new students and keep them motivated throughout the

project. These results introduce the role of advisor as a parameter in effectiveness of the research groups. Crede and Borrego (2012) offered a study on how research groups foster such qualities for students. This study reported on several elements including communication, resources, and role of advisor, in relation to the group size. Results indicated that mid-size groups (5 to 20 students) offer a balance in communication and resources. Students in these groups tend to ask for support from the advisor as well as other students. Further, these students stated that the advisor did a better job in communicating clear expectations. The advisor role in such groups generally includes enculturation and gatekeeping. Further, larger groups (11-20) provided better funding opportunities for students. However, the study also revealed that students feel more comfortable speaking in small groups (less than 5).

This work examines a group at California State University Fresno as a case study. This group consists of junior and senior undergraduate and graduate students as well as former members who are participating as alumni. The major focus of research within the group is resilient and sustainable structural mechanics and design. The group meets once every three to four weeks, either in-person or via web, to share their current work through presentations. Further, the faculty adviser provides guidance on essential communication skills, such proposal development and professional presentation. Slide and video presentations are archived and shared for future reference. The meeting is well attended by both members and guests, including non-member students, faculties, and the dean. These meetings enable presenting students to obtain feedback and comments from their fellow classmates and alumni in a friendly environment. The unique composition of the group also allows members to improve their ability to reach audiences at various academic levels, from undergraduate freshmen to senior graduate students and even practicing engineers. Further, younger members have the great opportunity to learn about current research projects and presentation skills. Moreover, students continue to develop their research skills, including development of ideas, proposals, literature studies, methodologies, and reports, during individual advising sessions. Students learn how to present their work using slides, posters, lectures, and documents. Furthermore, students are fully supported to apply for graduate studies, internship, and funding opportunities.

## **Methodology**

This section outlines the methodology that has been employed to ensure academic and professional success for members of the research group. The proposed methodology focuses simultaneously on concerns for people and results. These are identified as the two dimensions of style approach to team management in Hersey et al. (1984). The primary tenets of the methodology with concern for people are:

1. Recruiting students from all academic levels to create cross-generational relationships
2. Regular in-person and online meetings to promote effective communications
3. One-on-one consultation with faculty as an essential advising approach
4. Mentorship and networking opportunities in small, student-led groups to foster teamwork and leadership
5. Group support for academic and professional goals to develop recognition for life-long learning

These tenets are discussed further in the following sections of this paper. With the exception of recruitment, the tenets are not discussed directly. Rather, the remaining tenets are discussed holistically in relation to the general procedure of the group, the diversity of the student body, the

projects undertaken by the group, and deliverables provided by members. It should be noted that diversity is perceived as an overlay on the entire procedure, rather than a stand-alone component. In addition, note that the concern for results<sup>4</sup> is exhibited in the methodology for assessing outcomes of the research group, which is discussed as part of the sections on projects and deliverables.

*Recruitment.* To join the group, students take part in an interview with the supervising faculty. The purpose of the interview is to evaluate the student's academic preparation, motivation, dedication and commitment toward research, teamwork, and potential for growth. Prospective interviewees are not chosen exclusively by the supervising faculty. Current group members are encouraged to recommend interviewees, and this is recognized as an essential component in ensuring the sustainability of the group. This process assures that junior members can develop their skills gradually to fill the position of senior members in the interest of continuity. Currently, active members of the group consist of five undergraduate students, six graduate students, and four alumni members who are actively presenting and attending meetings in addition to working on their own projects.

*Procedure.* An ideal research program for students begins at junior level. At this stage, students explore possibilities in research under supervision of the faculty advisor. They learn key components of research and proposal development through general studies, attending presentations, and helping senior students. Junior students meet the faculty advisor once a month to discuss their research interests as well as academic and career goals. As students make progress toward senior status, they begin writing proposals on selected topics. Undergraduate students also participate in major research projects by assisting graduate students. Their training at this stage includes laboratory safety, literature studies, data mining, documentation, and presentation skills. At senior level, students may choose to enroll in an independent study, implement their research skills in senior design project, or define an undergraduate thesis. At this stage, they meet advisor at least twice a month to learn about experimental and analytical studies. A typical undergraduate research should develop and implement either an experimental or an analytical plan using available resources in college.

At graduate level, students incorporate all previous components at a higher academic level. A typical graduate research includes both analytical and experimental studies in addition to literature studies, data mining, etc. Fresh graduate students coming from other schools may need additional training on research methods and components, if they have not learned them during their undergraduate programs. Further, graduate students are expected to mentor their undergraduate assistants in the laboratory. Therefore, developing supervising and mentorship skills are another part of their training. To accomplish such extensive training, graduate students meet the faculty advisor at least once a week. To prepare graduate students for PhD programs, they also participate as teaching assistant and grader, as well as developing proposals for external funding. Alumni members of the group maintain their contribution by presenting their work in other institutes and organizations as well as sharing their experience and advice with new students. Such contributions also provide an opportunity for networking and development of partnerships between students as well as institutes.

*Diversity.* Current members represent significant participation by underrepresented groups, including Hispanic and female students. Figure 2 and Figure 3 show trends of students advised by supervising faculty in the past four years. The research and practice group was initiated in fall 2011. Thus, these figures clearly indicate the impact of the research and practice group on number of Hispanic and female students. The average percentages of Hispanic and female students over the past three years are 67% and 44%, respectively. These values are substantially higher than university, college, and department statistics, as shown in Table 3<sup>14</sup>. Such participation is outstanding and essential for the civil engineering program in a Hispanic Serving University, which is also a non-Ph.D.-granting institution. The research group has also successfully collaborated with other groups serving underrepresented students and communities, including Louis Stokes Alliances for minority Participation (LSAMP), Engineers Without Borders (EWB), Society for Advancement of Chicanos and Native Americans in Science (SACNAS), etc.

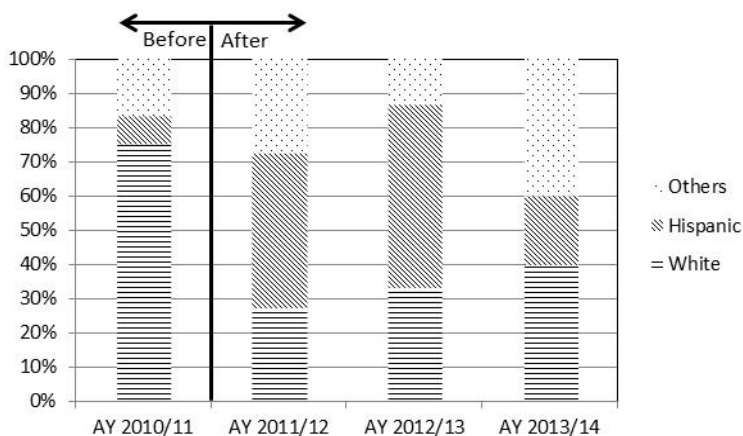

Figure 4. Group diversity with respect to ethnicity.

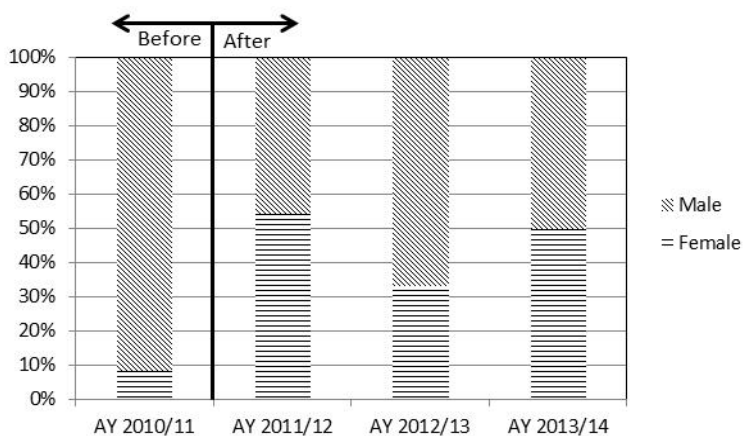

Figure 5. Group diversity with respect to gender.

Table 3. Demographic data

	Group Members	Department	College	University
Female students	44%	19%	13%	58%
Hispanic students	67%	39%	37%	41%

*Projects.* The focus of the group is resilient and sustainable structures, structural mechanics, and design. Research projects are developed based on student interests and their academic preparations. These projects typically include undergraduate and graduate thesis, projects and independent studies, as well as self-sustained projects. Senior undergraduate students may also present their senior design project, if the project includes innovative components that require research. Projects are customized based on the level of academic preparation of the individual student. Projects are generally planned for one or two semesters with possibility of extending the project in multiple years. Limiting each phase to one or two semesters gives students an opportunity to present their work, obtain feedback, and gain sense of accomplishment at least once a year. This aspect of the program was designed to motivate students to continue working on more long-term research programs.

*Deliverables.* Common deliverables for research projects include multiple written and oral presentations. Written reports include project proposals, progress reports, final project reports, and articles or technical papers appropriate for engineering magazines and journals. Poster, slide, and conference presentations are also part of project deliverables. Participation in university showcase events provides an opportunity for students to share their work with the university community. The faculty advisor also presents the group profile in an annual brochure. The current brochure includes complete list of participants, projects, presentations, and publications. If supported by the college, the faculty advisor may expand this brochure to an online digital publication, including articles and presentations.

## Results

This section assesses the efficacy of the methodology using a variety of methods. Results are presented in three sub-sections. First, the level of student success achieved by the group is presented qualitatively in terms of the achievements of the group's members. This includes a brief discussion of completed projects, research funding, and group presentations.. Second, the results of a survey are presented. The survey was provided to current members of the group, as well as general members of the student body. Third, a novel assessment metric is implemented. This assessment metric uses Latent Semantic Analysis to compare passages written by students (describing their skills and professional aspirations) to a set of learning outcomes. These outcomes are adapted from those of the American Society of Civil Engineers (ASCE) and Accreditation Board for Engineering and Technology (ABET).

*Qualitative Student Success.* The research group was started in 2011. Since its inception, members have received support for a variety of activities, including design projects, proposal-writing, communication of results, and team collaboration. Measurable outcomes of this support include:

1. Approximately 25 presentations given by students during group meetings
2. 4 journal papers in review
3. \$44,300 in research funding secured by group members
4. More than 15 senior projects mentored through the group

These qualitative indicators demonstrate that the group provides students with a number of opportunities to encourage their success.

*Survey Results.* Seven current group members and 26 non-member students participated in the survey. All were civil engineering students. Characteristics regarding the group and non-group members are summarized in Table 4.

Table 4. Composition of respondent pool

	Group Members	Non-Group Members
Total number	7	26
Junior and Below	14%	42%
Senior	29%	58%
Graduate	57%	0%
EIT Passed	71%	27%

Questions provided only to non-group members were intended to query their interest in participating in a research group. This was accomplished by querying their interest in a group that would support and offer feedback on a variety of activity. Several questions also asked if such support or feedback was being supplied by other groups. A positive response to a question was one that indicated interest or fulfillment, while a negative response was the opposite. A summary of these results is provided in Table 5.

Table 5. Non-group member survey questions and results.

No.	Question	Response Type	Response Classes	Response %
1	If given the opportunity, would you participate in a group that would offer support and feedback for research activities?	Free Response	Positive Negative	88% 12%
2	Do you already participate in a group that offers support and feedback for research activities?	Free Response	Positive Negative	12% 88%
3	If given the opportunity, would you participate in a group that would offer support and feedback for your senior project?	Free Response	Positive Negative	100% 0%
4	Do you already participate in a group that offers support and feedback for your senior project?	Free Response	Positive Negative	4% 96%
5	If given the opportunity, would you participate in a group that would offer support and feedback for academic presentations?	Free Response	Positive Negative	92% 8%
6	Do you already participate in a group that offers support and feedback for academic presentations?	Free Response	Positive Negative	0% 100%

The results from this set of surveys indicate that there is a large desire for feedback and support regarding senior projects, academic presentations, and research activities. At the same time, the survey results indicate that these needs are largely not being fulfilled by other organizations. Therefore, the expansion of undergraduate research may be beneficial for ensuring student success of the student body. Questions provided only to group members were intended to examine their experience as part of the group. Table 6 provides a list of questions that were only provided to members. Here, a positive response indicated agreement.

Table 6. Group member survey questions

No.	Question	Response Type	Response Classes	Response %
1	What was your motivation for becoming part of the group?	Multiple Choice (all that apply)	Academic Career/Professional Personal goals Other	71% 100% 29% 14%
2	What is your motivation for continued involvement in the group?	Multiple Choice (all that apply)	Academic Career/Professional Personal goals Other	86% 86% 71% 14%
3	Do you feel that the group gives you support and feedback for research activities? Why or why not?	Free Response	Positive Negative	86% 14%
4	Do you feel that the group gives you support and feedback for your senior project? Why or why not?	Free Response	Positive Negative	86% 14%
5	Do you feel that the group gives you support and feedback for your academic presentations? Why or why not?	Free Response	Positive Negative	71% 29%

In responding to Question 1, most participants selected either academic or career/professional goals, and only 29% selected personal goals as their motivation for becoming part of the group. However, in responding to Question 2, a much higher proportion of students selected personal goals as their motivation for continued involvement in the group. The large increase in the number of respondents who selected personal goals (an increase of 43%) indicates that group members internalized responsibility for their own success. In addition, nearly all members stated that they received support for a range of activities as part of the group (Questions 3, 4, and 5). This indicates that the non-group members could actually have those needs fulfilled as part of the group.

*Latent Semantic Analysis.* Latent Semantic Analysis has been used extensively in the design theory and methodology literature for comparing written description of design solutions<sup>10,11</sup>. At its most basic, Latent Semantic Analysis (LSA) is a computational tool that compares documents based on the relative frequency of occurrence of words. More specifically, a word-by-document matrix is first created. Columns represent documents, and rows represent unique words occurring in the total corpus of text. A weighting is then applied to the matrix to condition the data. In this work, log-entropy weighting was used because it has been shown to perform well across many data sets<sup>12</sup>. Finally, documents are compared by calculating the cosine similarity between columns. The cosine similarity metric ranges between 1 (indicating that the two documents are identical) to -1 (indicating that the two documents are *extremely* dissimilar).



A portion of the survey collected a written response to the prompt: “Describe yourself as an engineering student. Discuss relevant strengths, personal attributes, and experience”. Participants were asked to refrain from substantially editing or revising their response. The participants’ written responses were compared to a list of educational outcomes using LSA. Rather than state “cosine similarity to education outcomes” throughout the following discussion, we will simply use “cosine similarity” as the preferred terminology. The average response length was 84 words. Two-dimensional representations of the LSA analysis were produced by performing non-dimensional scaling on the document-similarity matrix using the MATLAB Statistics Toolbox<sup>13</sup>. The axis labels,  $x_1$  and  $x_2$ , indicate the components assigned by this analysis. Figure 4 depicts the relationship between members and non-members with respect to the list of outcomes.

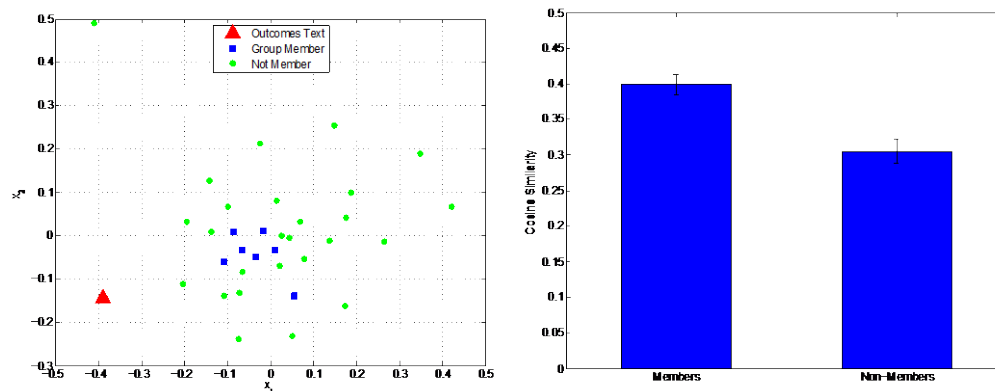

Figure 6. Relationship between written responses for group and non-group members. (error bars show  $\pm 1$  S.E.)

In the two-dimensional representation, non-group members show a large amount of variance, as might be expected, while the group members are tightly grouped. The group members show a significantly higher level of cosine similarity than do non-group members ( $\rho = 0.006$ ,  $F = 8.760$ ). In other words, the responses written by group members are more similar in content to the list of outcomes than those of non-group members. This could indicate that group members more effectively embody and communicate ASCE and ASEE outcomes. Figure 5 compares the cosine similarity of different education levels.

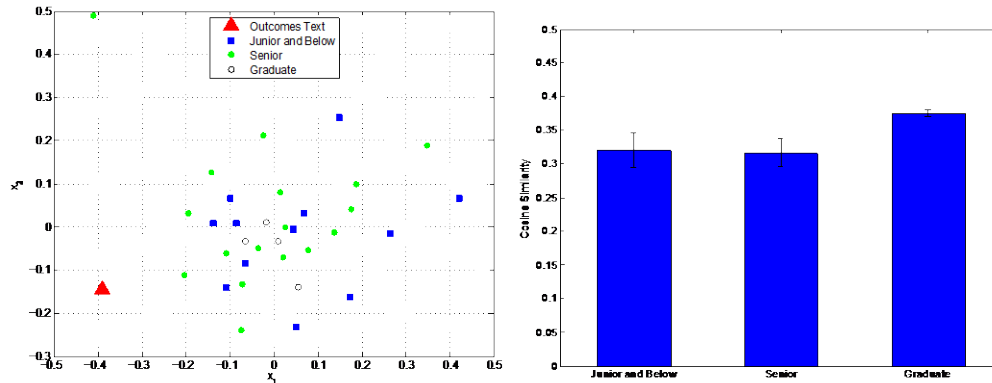

Figure 7.

Relationship between written responses for different educational levels. (error bars show  $\pm 1$  S.E.)

There was not a statistically significant difference between any two of these three groups (juniors and below, seniors, and graduates). Therefore, it is more likely that the higher cosine similarity of group members was caused by association with the group. A possible limitation of the current analytical results is that no attempt was made to control for individual aptitude. Students that excel because of personal aptitude could be more likely to join the research and practice group and would also, seemingly. Additionally, the written statements provided by these students could have exhibited higher similarity to the outcomes text, making personal aptitude a driver for the difference between group and non-group members. In future work, this potential limitation could be addressed by collecting multiple written statements from students on an annual basis. This would allow the impact of participation in the research and practice group to be examined in a temporal sense.

## Conclusion

In this paper, we introduce a methodology for the effective delivery of a Research and Practice Group to ensure student success. This methodology is grounded in encouraging an integrated experiential learning environment. The methodology also draws upon both situational leadership and relational leadership models. The five primary tenets of the methodology are discussed, and we justify their inclusion by demonstrating support for similar strategies in the literature. In less than 3 years, this group has provided many opportunities for student to ensure their own success. This includes research funding generated by the group, group presentations given by students, and mentoring for senior projects. In addition, a survey was administered to both group and non-group members. The results of the survey indicate that the general student body desires participation in such a research group; that the group does provide support and feedback for members; and that the group provides a transformative process that allows members to develop personal goals. Further, we compared written samples of students' self-descriptions to a list of expected education outcomes (developed from ASEE and ASCE standards). Group members showed significantly higher similarity to the list of outcomes than non-group members, indicating their enhanced ability to internalize and communicate those outcomes. This combination of both quantitative and qualitative evidence supports the efficacy of the group methodology proposed in this work.

## References

1. ASCE. 2008. *Civil Engineering Body of Knowledge for the 21st Century*. 2<sup>nd</sup> Ed. ASCE Press.

2. Tehrani, F. M. 2011. Implementing Situational Leadership in Engineering Classrooms. *Proc. Pacific Southwest section of American Soc. for Engrg. Edu.*, California State University, Fresno. 114-124.
3. ABET (Accreditation Board for Engineering and Technology). 2010. *Criteria for Accrediting Engineering Programs*. Baltimore, MD: ABET. ([www.abet.org](http://www.abet.org)).
4. Hersey, P., Angelini, A.L., & Carakushansky, S. 1982. The Impact of Situational Leadership and Classroom Structure on Learning Effectiveness. *Group & Organization Studies*. 7 (2), pp. 216-224.
5. Komives, S. R., Lucas, N., & McMahon, T. R. (2009). *Exploring leadership: For college students who want to make a difference*. John Wiley & Sons.
6. Abbas, A, H. Y Alhammadi, and J. A Romagnoli. 2009. Process Systems Engineering Education: Learning by Research. *Chemical Engineering Education*. 43, no. 1: 58-64.
7. Crede, E, and M Borrego. 2012. Learning in Graduate Engineering Research Groups of Various Sizes. *Journal of Engineering Education*. 101, no. 3: 565-589.
8. Duarte, C, H. P Oliveira, F Magalhaes, V. G Tavares, A. C Campilho, and P. G de Oliveira. 2012. Proactive Engineering. *Proceedings of the 2012 IEEE Global Engineering Education Conference (EDUCON)*. 1-5.
9. Gordon, Bernard M, and Michael B Silevitch. 2009. Re-engineering Engineering Education. *New England Journal of Higher Education*. 24, no. 1: 18-19.
10. Dong A., and Agogino A. M., 1997, Text analysis for constructing design representations. *Artificial Intelligence in Engineering*, no 11:2, pp. 65-75.
11. Dong A., Hill A. W., and Agogino A. M., 2004, A Document Analysis Method for Characterizing Design Team Performance. *Journal of Mechanical Design*, no 126:3, pp. 378-385.
12. Landuar, T. K., Foltz, P.W., and Laham, D., 1998, Introduction to Latent Semantic Analysis. *Discourse Process.*, no 25:2, pp. 285-307
13. Kruskal, J.B., 1964. Nonmetric multidimensional scaling: a numerical method. *Psychometrika*. 29, pp 115-129.
14. Office of Institutional Effectiveness (OIE), 2014. Quick facts fall 2013. California State University, Fresno. ([www.fresnostate.edu/academics/oie/quickfacts](http://www.fresnostate.edu/academics/oie/quickfacts)).

## **The Design and Construction of a Tiny House: Small Is Beautiful**

John Murray, Erin Elder, Ryan Bingham,  
Glen Longhurst, and Desmond Penny  
Southern Utah University

### **Abstract**

The Danish scientist and poet, Piet Hein said, “Art is solving problems that cannot be formulated before they have been solved. The shaping of the solution is part of the answer.” Hein’s statement sets the stage for a senior capstone project involving two Southern Utah University (SUU) students majoring in Integrated Engineering, and justifies their undaunted roving among the disciplines to create a sustainable, esthetically pleasing, 160 square-foot ‘Tiny House’ for their client, an emergency medical technician and phlebotomist. The off-grid, solar-powered, 20’ L x 8’ W x 13.5’ H structure is permanently attached to a flat-bed trailer. Viewed from afar, the house is evocative of a miniature, ocean-going yacht sailing leisurely into port at sunset, yet sturdily equipped for unforeseen, gale-force winds. The designers operated within severe budget constraints, an aggressive schedule, evolving specifications, a network of volunteers, and lofty sustainability goals. This design/build project illuminates the grace of great things, the enthusiasm that drives us to embark on uncharted waters in pursuit of grand challenges such as discovering new continents, purchasing a home of less than 2000 square feet, or taking time for coffee, croissants, and a good book in a clean, well-lighted place. The project required a radical spirit, and a willingness to traverse unfamiliar cultural terrain to communicate with donors, architectural experts, and diverse community members. The students, case-hardened, relatively unscathed, and still inspired, are no longer strangers in the strange land of the arts, and are more deeply enmeshed in the sciences. Paraphrasing educator Jerome Bruner, the students, eclectically coached, constructed their own world. Why challenge current housing norms? The organization Architecture 2030, faced with the fact that 48% of the energy consumed in the United States is used in the operation and construction of buildings, is encouraging new buildings, developments, and renovations to be designed to be carbon-neutral by 2030, using no fossil fuel, greenhouse gas emitting energy to operate. Quantitative connections between energy, ecology, and economics revealed by systems ecologists Howard & Eugene Odum also indicate the desirability of smaller buildings, accessible via local transportation, that minimize energy use, maximize efficiency, employ solar technologies, and recycle materials. The Tiny House constitutes a small step in the direction of these goals. Periodic design reviews, selective design iterations, management by walking around, and systematic performance monitoring constituted effective assessment methods. We have endeavored to capture the gestalt of the project in this paper.

### **Tiny House Origins**

The Tiny House, illustrated in Figures 1-6, emerged from several sources, including participation by the capstone students, Erin Elder and Ryan Bingham, in two junior-level Integrated Engineering courses focused on sustainable design; lively conversations between the students and the client; extensive exploration of the literature on creativity, low-impact architecture, regional and community planning, systems thinking, and green construction<sup>1-27</sup>; examination of online documentation describing the design of small, tiny, nano, eco, and indigenous housing;

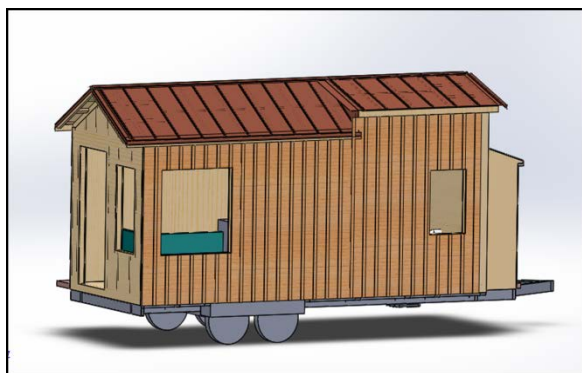

Figure 8. Tiny house, SolidWorks image.

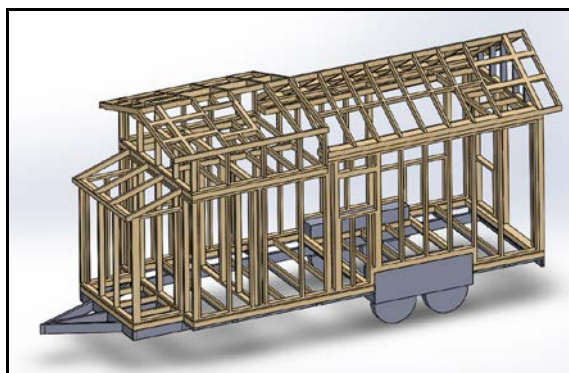

Figure 2. Structural rendering.

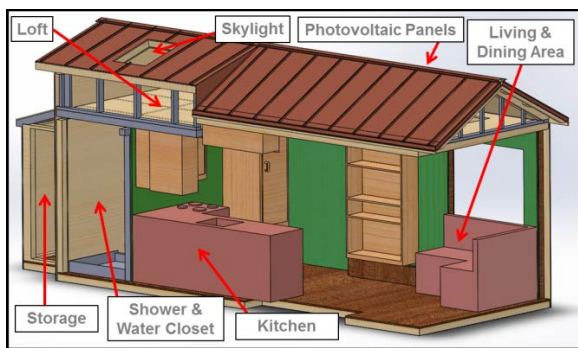

Figure 3. Interior rendering.



Figure 4. Tiny house under construction.

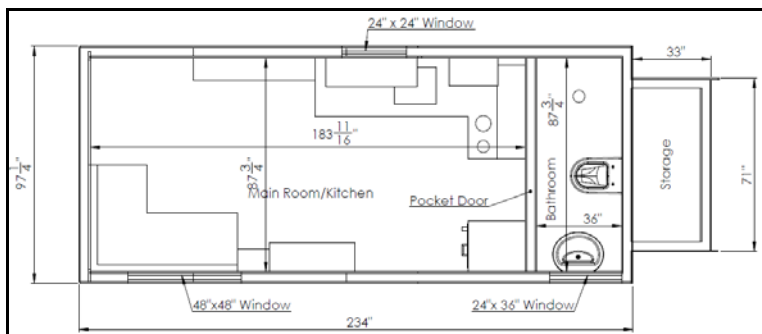

Figure 5. Tiny house plan view: Lower level.

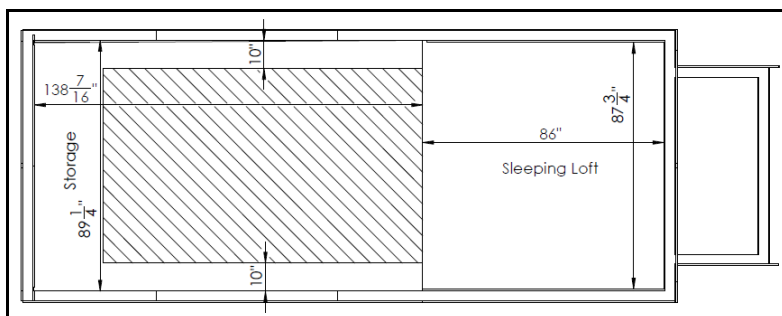

Figure 6. Tiny house plan view: Upper level.

encouragement on the part of the faculty, staff, and administration; and, importantly, provision of the \$15,000 required to complete the project by the client. Experience with design and construction gained through three intensive DesignBuildBLUFF<sup>29</sup> projects during 2009, 2012, and 2013, in which students at the University of Utah, University of Colorado, Denver, and Southern Utah University created architecturally innovative, pro bono homes for Navajo families living on the reservation near Bluff, Utah also proved beneficial in achieving project liftoff<sup>30</sup>.

### **History, Experimental Housing, and Public-Private Partnerships**

The Lakota proverb, “A people without history is like the wind on the buffalo grass: The wind blows and the grass bends,” suggests that design intent can be interpreted productively in terms of historical developments as well as scientific, technical, and artistic advances. The Wall Street-induced, unfettered financial debacle of 2008 resulted in a substantial tightening of credit by banks and other lending institutions. Obtaining mortgage loans became increasingly difficult for individuals and couples just starting out in life, and for those of strong character, but modest means. An upward, inevitably unsustainable, redistribution of wealth had taken place, with insufficient public outrage, constructive legislative involvement, or serious investigative journalism ensuing to fully ferret out the underlying issues, expose them to the light of day, and bring about the necessary reforms.

Fallout spreading from the 2008 financial crisis promptly caused median and low cost housing starts in the United States and elsewhere to plummet. With the exception of projects initiated by well-capitalized or exceptionally innovative firms, only the most financially promising housing endeavors were realized. Experimental housing was rarely implemented in this extraordinarily conservative fiscal environment, with the exception of bold endeavors such as the Department of Energy’s Solar Decathlon, and university-sponsored or philanthropic projects emanating from organizations such as The Yale Building Project, Rural Studio<sup>31</sup>, DesignBuildBLUFF, Studio 804, Fay Jones School of Architecture, Habitat for Humanity, Make It Right, Neighborhood Design/Build Studio, and Architecture for Humanity.

Fortunately, these unexpected changes in the financial environment resulted in novel, Darwinian adaptations by intrepid individuals seeking shelter in a manner strikingly similar to that of other highly disturbed, natural systems. Paradigm time had clearly arrived, and alternative approaches to architecture were investigated by trailblazing designers and seekers alike, in some instances causing them to merge roles. The transformative nature of these unforeseen fiscal events is not surprising. For millennia, individuals, families, and communities have regularly conspired to create architecture without architects<sup>32</sup>, engineers, builders, realtors, or the overarching specter of voracious money lenders to contend with. Adequate, sometimes elegant housing has been fashioned within rural and urban communities globally using locally available, scavenged, or otherwise low-cost, high-quality materials, and labor reciprocally provided for the common good. In this context, the architectural mantra, “design is the ultimate renewable resource,” the indigenous, belief that “we are all related,” and the holistically inspired development of “a sense of place” take on renewed meaning. Redesign, restoration, and recycling of the endangered global commons, including shelter, it has been suggested, may represent an emerging, contemporary form of redemption.

The well-publicized, “small house movement,” a socially progressive manifestation of the trend toward low cost, sustainable architecture has recently expanded, partly as a result of the fiscal crisis. This timely, compact housing crusade has yielded a spectrum of innovative solutions, among which include the miniscule dwellings known as ‘small,’ ‘tiny,’ or ‘nano’ houses. According to the Financial Times, from the mid-1970s through 2007 the average size of homes in the United States increased from 1,780 square feet to 2,479 square feet. In the last two decades, smaller structures, ranging in size from 500 square feet to as little as 60 square feet have burst forth on the building scene, reversing the expansionary trend of past decades ever so slightly. These small-scale structures differ from the majority of standard recreational vehicles, commercially manufactured homes, and trailers; designs span the spectrum from highly customized, modern architectures forged from steel and glass to prefabricated, architecturally traditional bungalows made of wood and stone. The quality of materials, attention to detail, sustainability, relative permanence, and aesthetic appeal are also often greater.

Significant barriers to the widespread creation of smaller homes still remain, however, according to Tree Hugger Magazine, including the cost of land, the availability of affordable loans, minimum housing size laws, social pressures, and fear of the unknown. Mindful of these barriers, such diminutive dwellings continue to satisfy a need for simple, affordable shelter that reflect some of the goals of the New Urbanism Movement toward the creation and restoration of diverse, walkable, compact, vibrant, mixed-use communities assembled in a more integrated fashion. These owner-built, and commercially-constructed small homes typically range in price from \$15,000-\$65,000, and are, in some cases, installed permanently on flat-bed trailers, making them and their occupants highly mobile.

With these developments and the current fiscal environment in mind, a public-private partnership to design and build an experimental, 160 square foot ‘Tiny Home’ for our adventuresome, motivated client was initiated at Southern Utah University. The client would provide the funds, and the university would provide the design expertise and labor.

### **The System Design Process: Form and Function Are One**

Vitruvius, a 1<sup>st</sup> Century Roman architect, engineer, and chronicler of ideas<sup>33</sup> wrote articulately about three qualities he considered desirable in a building: commodity, firmness, and delight. According to architect Hal Box<sup>34</sup>, these terms translate to “functional workability, structural and mechanical soundness, and delight of the senses.” The first step in achieving these qualities in the Tiny House involved working closely with the client to obtain a general idea of what she wanted to build, its overall purpose, and where the resulting structure might reside. Forming these initial thoughts into specific requirements, according to Box, constitutes the architectural process known as ‘programming.’ The client’s expressed intent was to live where it was warm in the winter, cool in the summer, and to remain highly mobile so that she could set up professional base camps, as necessary, in close proximity to emergency situations or regional disaster areas and, outside of work hours, pursue a spectrum of nomadic, personal adventures. She said she would like the Tiny Home to be both beautiful and include the following:

1. Compact, esthetically attractive, comfortable ‘great room,’ or primary living space, one that should, ideally, provide a feeling of openness and light
2. Sleeping area, with skylight, located in a loft above the other living spaces
3. Kitchen, with a sink and propane stove

4. Bathroom, with a shower and composting toilet or water closet
5. Large windows, wherever possible, to provide expansive views of the outdoors
6. LED lighting
7. Adequate storage space
8. Off-grid photovoltaic (PV) system for producing electricity, with appropriate hardware (PV array, batteries, charge controller, inverter, balance of system components), capable of supporting the anticipated energy budget, plus an interface to an external, fossil fuel-based generator capable of supplying large electrical loads (such as a compact air conditioner) in summer, providing electrical power during extended periods of inclement weather in winter, and permitting rapid battery charging whenever necessary
9. Propane space heater, and on-demand hot water heater
10. Ventilation system, including ventilation and ceiling fans, plus propane and carbon monoxide detectors
11. Domestic water storage tank, with a three-day water supply capacity
12. Grey water storage tank
13. Front porch
14. External interfaces to allow the house to connect to electricity and water access points at parks, campgrounds, and RV-compatible locations
15. Conformity to appropriate RV construction and transportation codes and regulations
16. Equipment allowing the house to be easily attached to, removed from, and transported via pickup truck

During programming, many existing small house designs were explored, and their features evaluated for possible incorporation. Establishing a harmonious relationship between the desired spaces and the related subsystems, given the apparent “simplicity” of the program, turned out to be surprisingly complex. The sleeping area consists of a loft located above the other living spaces, and the great room, located near the front of the house, includes both the sitting and dining areas. The kitchen is located adjacent to these spaces, and the bath area is located toward the rear of the house, on the end opposite from the front door. Storage spaces are distributed throughout the house in the most functional manner possible, and batteries and hardware for the photovoltaic system are located under the great room couch. The gray water tank, necessary for holding outflow from the shower and sink, is located beneath the floor, and the main, domestic water tank is located inside the main storage structure. Juggling these design details and physically ordering the subsystems in 3D space required the designers to develop heightened spatial perceptions, achieve unusual visual dexterity, and involved considerable serendipity and good humor.

The second, or ‘schematic design’ phase of the project, required that the students work closely with engineering faculty, external pro bono consultants, and business owners having expertise in structural, thermal, electrical, photovoltaic, construction, plumbing, and roofing systems. Materials selection was also a critical element in the design process, since financial constraints limited the scope and ready availability of specialized materials. Early in the project, it was decided to employ traditional stick (wood frame) construction to minimize initial construction costs and maximize immediate access to locally available materials. Interiors consisting of tongue and groove wood paneling and flooring were designed. Wooden siding covers the exterior surfaces. A metal roof was selected for use, primarily to minimize maintenance and



replacement costs. Wind, vibration, and snow loading of the road-worthy Tiny House required that additional structural features and specialized fasteners be used to assure the integrity of the system under worst-case loading conditions. Physically testing the structure, while construction proceeds toward completion, will assist in verifying the system's overall structural integrity. The exact dimensions of the required spaces were also partly defined by the availability of an affordable, 22 foot-long trailer capable of supporting the anticipated weight of the system, approximately 7,500-10,000 pounds, and by important human factors, i.e., assuring sufficient room existed for the client to maneuver effectively in the kitchen, great room, bathroom, and loft; allocating space for the necessary appliances and cabinetry; and determining the amount of storage required for the client's current and future possessions. The spatial optimization problem the student designers encountered is roughly analogous to positioning flexible paper dolls and an array of miniature furniture and appliances into a finite-sized, yet spatially as-yet-undefined doll house. The solution to this classic 'box packing' problem from computer science finally yielded not to rigorous mathematical analysis, but to art, intuition, and experience, plus a desire on the part of the client to minimize unnecessary "stuff." Hand sketches and the computer-aided analysis and design (CAD) software package, SolidWorks, were used to draw, analyze, implement, and modify Tiny House systems on paper and on screen as they matured.

The electrical energy required for the house, determined in conjunction with the client to be approximately 2.43 kWh/day, is provided by an off-grid, onboard, roof-located PV system, to be followed later by the inclusion of an external, fossil-fuel powered auxiliary generator. It was determined that the solar radiation level and ambient temperature range in SW Utah required a 1.08 kW photovoltaic array to generate the prescribed electrical load. The cost of this PV system exceeded the initial PV system budget allocation of \$6,000, including the cost savings associated with federal and state tax credits. As project completion rapidly approaches, and cost savings continue to accrue from donated, scavenged, and recycled materials, the initial PV budget allocation will be re-evaluated, and adjustments made in system sizing, if necessary, and an appropriate PV system installed.

A detailed thermal analysis of the house was also performed, with required insulation and space heater sizing based on the associated calculations. Insulation ranged between R-10 and R-20 in the walls, ceiling, and floors, depending on the particular structural entity involved. Windows with U values of approximately 0.3 were used. It was concluded that a marine environment-suitable, propane space heater, capable of supplying 9000 BTU/hr, is sufficient for most winter operating environments. Another, less expensive space heater is also under consideration. The third, or 'design development' phase of the project, consisted of redesigning, refining and integrating all the subsystems for the house as they evolved, developing an initial construction schedule, obtaining component cost information, and creating an overall system cost estimate. In hindsight, the students and supporting faculty gradually discovered that highly complex projects often require more time, money, and effort than originally anticipated. They also learned the benefits of including hard-to-quantify implementation factors surrounding construction time and resource requirements based on the experience of others on similar projects.

All available design documents, system costs, and schedule estimates were reviewed by SUU faculty, administrative personnel, capstone students, and the client. A contract was then prepared and signed. Traditional bidding and negotiation of construction subcontracts was only required in

the case of the photovoltaic (PV) system. It was determined at the outset of the project that regulatory considerations, electrical and fire safety, procedures for obtaining federal and state tax credits, and minimizing the time required for PV system implementation necessitated the use of a professional, certified PV installer. It is worth noting that the Tiny House is also considered 'mobile' by regional agencies because it is attached permanently to a flatbed trailer. It is therefore classified as recreational vehicle (RV) for regulatory purposes. This fact helped reduce the time and expense associated with conventional residential building inspections. The Tiny House was designed and implemented to conform to the NFPA (National Fire Protection Association) 1192 Standard on Recreational Vehicles.

The final, ongoing, 'construction' phase of the project required that a secure, weatherproof building capable of containing the 20' x 8' x 13.5' Tiny House be found, and that tools, materials, and volunteers be obtained. Fortunately, SUU's Facilities Management Department was able to provide the Tiny House crew with the use of a large, metal, Butler building, located on the SUU farm two miles from the main campus, for the duration of the project. Although the building is unheated, the working area provides a roomy, hospitable environment in which students, faculty, volunteers, and visitors can operate comfortably with appropriate clothing. Bovine symphonies emanating from nearby cattle barns also offer harmonious embellishments rarely encountered on urban campuses. Tools for construction were borrowed from various sources, including the SUU Construction Management Program, the Integrated Engineering project fabrication area, or were purchased using departmental funds. Safety during construction was deemed paramount by all parties, with students and volunteers required to demonstrate proficiency in tool use, or receive on-the-spot instruction. Safety glasses, fire extinguishers, and first-aid kits were also made available. The SUU development office offered the students valuable assistance in working with regional businesses to obtain donations of building materials and discounts. The majority of the required Tiny House materials were purchased directly from building supply firms and discount construction supply outlets using client funds deposited in an SUU-managed account.

### **Community Interactions**

The Integrated Engineering (IE) Program at SUU has, since its origin in 2005, included project-based, cross disciplinary, experiential learning combining elements of Electrical Engineering, Mechanical Engineering, and Civil Engineering in the integrated curriculum. All IE students are required to complete two one-semester design courses during their junior year, plus two, advanced, one-semester courses focused on the design and implementation of a capstone project during their senior year. Students often develop capstone projects for regional private and public sector organizations as well as within the university. Southern Utah University has recently increased its emphasis on experiential learning on a university-wide basis. According to the university, this process should "contribute to a high-caliber education by allowing students a formal opportunity to create their own experiential learning project while developing a richer and more sophisticated understanding of honoring the merger of thought and action." Engineering students are well-prepared to implement these evolving, transdisciplinary goals, and should become more fully integrated into the broader university community as a result.



Fig. 7. Tiny house volunteers

It was decided that the Tiny House, a senior capstone project of small scale but substantial scope, would benefit greatly from a network of community volunteers (Figure 7) to assist in the construction process if the house was to be completed in a timely manner. Publicity surrounding previous DesignBuildBLUFF projects, helpful contacts within the university's public relations, development, and purchasing offices, thoughtful reporters from regional newspapers, talented photographers and videographers,

on-campus service organizations, the SUU Community Engagement Center, the Integrated Engineering

Industry Advisory Board (IAB), and word of mouth (a highly effective mobilizing mechanism in a close-knit university community) allowed a crew of approximately sixty-five volunteers from a range of backgrounds to be assembled to work on the Tiny House whenever their schedules permitted, thus gaining valuable experience and exercise themselves, and creating considerable camaraderie in the process. Regional building supply firms were also approached for building material donations and technical advice. The support received by the project from these on-campus organizations, media professionals, and commercial firms was heartening. As construction, systems integration, and testing progressed, their continued efforts have proved invaluable. Started in May, 2013, completion of the Tiny House is anticipated in late April, 2014. "We are bound," as blue water sailors sometimes say, "for home."

### **ABET Considerations**

ABET has specified eleven student learning outcomes that students should achieve in any accredited engineering program. They include the following:

- a. An ability to apply knowledge of mathematics, science, and engineering
- b. An ability to design and conduct experiments, as well as to analyze and interpret data
- c. An ability to design a system, component, or process to meet desired needs
- d. An ability to function on multidisciplinary teams
- e. An ability to identify, formulate, and solve engineering problems
- f. An understanding of professional and ethical responsibility
- g. An ability to communicate effectively
- h. The broad education necessary to understand the impact of engineering solutions in a global and societal context
- i. A recognition of the need for, and an ability to engage in life-long learning
- j. A knowledge of contemporary issues
- k. An ability to use the techniques, skills, and modern engineering tools necessary for engineering practice.

The Tiny House project helped the capstone students achieve nine of the eleven ABET outcomes as indicated below:

1. Engineering principles, especially those of structural engineering, heat transfer, electric circuits, electronics, fluid mechanics, statics, and dynamics were applied in the design process. These activities satisfy ABET outcome a
2. The residence was designed to meet the behavioral, structural, and esthetic specifications of a client. These activities satisfy ABET outcome c.
3. The complexity of the project required the student design team to exercise their engineering skills in an interdisciplinary manner. These activities satisfy ABET outcome d.
4. The students encountered a number of initially unanticipated engineering problems as the design evolved and following the start of construction. These problems were successfully addressed through analysis, design reviews, and revisions. These activities satisfy ABET outcome.
5. The project was built specifically for a client, involved a legal contract between the client and the university, and had to comply with regional codes and building regulations, thereby providing them with experience in the domains of ethics, professional responsibility, and environmental design. These activities satisfy ABET outcome f.
6. The students are preparing a full report on the project. During the course of the project so far, they have already made presentations to student groups, engaged in several design reviews involving faculty, administration, and the Tiny House client, and briefed the SUU Industry Advisory Board in detail on their activities. These activities have collectively demonstrated both oral and communication skills. These activities satisfy ABET outcome g.
7. The Tiny House project was initiated in response to a request that developed because of a growing trend toward smaller scale-housing that is becoming prominent, not only in the United States, but worldwide as well. These activities satisfy ABET outcome h.
8. The ongoing push for off-grid housing is another contemporary, energy and sustainability-related issue that this project responds to. These activities satisfy ABET outcome j.
9. The entire project was modeled in SolidWorks, and other engineering software used for thermal analysis.

### **Conclusions and Extensions**

What thoughts did the two capstone students have regarding the conception, design, and implementation of the Tiny House (Figures 8-13), recently renamed the 'Vagabond House,' by our adventuresome client? What was learned during the design/build process? What things would they do differently if offered the opportunity to engage in another, similar project? Selected reflections by Erin Elder and Ryan Bingham, edited for clarity and compactness, are included below.



Figure 8. Vagabond House assembly.

and active renewable energy systems, and custom design processes intended to be in harmony with the requirements of a low maintenance life style. My mind began to wonder: Could this be something I could do?

I made a phone call to my capstone project partner, Ryan, to run the idea by him. He considered it momentarily and answered with a comment, “How hard could it really be?” “Sure,” he said. Little did we know that we were jumping into something so big that neither of us could begin to comprehend it. Oh, boy, were we surprised!

We spent the beginning of each week just preparing to go into the 2-3 days of work at the site on the weekends, and still felt that we were unprepared. After a long week of planning and constructing, the ‘regulars,’ i.e. the Tiny House crew plus the volunteers who regularly show up to work, get together to unwind and enjoy the perks of the bond that forms between people...when they are simultaneously ready to ‘kill’ one another, yet are also highly appreciative of the amount of work each person has provided on this (major) project. I have learned more about construction than I ever want to know and plan on never picking up another hammer again when it is over! However, we have also learned what it is like to work together, and rely on the collective strengths of others where, individually, these strengths may be lacking. Patience and tolerance are not my strong suit, but my partners, Ryan and (client) Heather, possess it in spades. Also, where others tend to over and under analyze a situation, I often see things in a logical order, and can then act on the situation, when and if it is in the best interest of what we are trying to accomplish. Another major educational point in this project is that design and implementation are two different beasts that must be able to comingle. The words ‘In Theory’ and ‘In Practice’ are terms I now understand intimately.

As for things to do differently, I would have to say everything and nothing. I learned in school that the things I understand and remember best are those that I did wrong at least once. This whole project is a learning process. For every wall built, I have also built one more quickly,

Erin’s Reflections: The process of searching for a senior project for the Integrated Engineering degree at SUU is a difficult one. I had no idea what would be a good project. How to choose one that would not be too much or too little became a key question. A chance encounter with an old friend that I had remained close to took place at this time. She told me about a project that she was ready to embark on, the construction of her very own tiny home on wheels. I immediately liked the idea, since it took into account many of the design ideas

that we had been exposed to in my most recent junior design classes: sustainable living, the use of passive



Figure 9. Vagabond House, walls going up!

efficiently, and better. This goes for every part of this project from selecting the initial design medium (we began with Google SketchUp and now use SolidWorks), to soliciting donations, to finding dedicated volunteers.



Figure 10. Interior view.

This project has infiltrated every part of my life, both public and private. I discuss it at work, where my bosses are anxious to see the finished project, have donated supplies and equipment, and are giving me (paid) time off to finish. I also discuss it over drinks with my closest friends and family. We were also featured recently on the front page of a regional newspaper, and people ask us about the project everywhere we go.

One of the things I hope disseminating information about this project accomplishes is to provide more foresight for the students who will follow. It would be nice if they had a better idea of what is expected of them, which I have learned, over time, is less than we decided to take on, but also what they can actually accomplish.

Ryan's Reflections: This project has shown me the value of the integrated design approach. Given enough time, research, and tenacity, I can solve any problem. It has also shown me that I can work with a variety of people with varying backgrounds and capitalize on their individual skills.

The Tiny Home building process can also be summarized by our nail usage. We put three nails in, and took two nails out. Everything took longer than we imagined it would, and failure was always an option. The scale of the project might have been smaller than that of the average house, but the amount of work and knowledge required to complete it was as great or greater due to trailer and wall structural analysis considerations, PV system complexity, and the inevitably long learning curve associated with building construction.

I was excited at the beginning of the project to be able to design and implement an off-grid PV system, whose design was accomplished and reviewed by both the Tiny House crew and SUU faculty, but whose physical construction, unfortunately, had to be outsourced to a certified PV installer in order to obtain the necessary tax credits.



Proceedings of the 2014 American Society for Engineering Education Zone IV Conference  
 Copyright © 2014, American Society for Engineering Education

The structure required building code knowledge that we had never been exposed to, and required even more 'tribal knowledge' than could be obtained in a university setting. Another problem with the current project is the limited budget. We're in the process of building this house, including the PV system, for less than \$15,000. Taking into account that the PV

system in itself is about half of the total house cost, and the fact that we're building this mobile house for less than fifty dollars a square foot, the project is do-able at contractor rates, but difficult to accomplish at consumer rates.



Figure 12. Erin on Loft.

In our design there are a lot of things that I'd do differently. First, we needed a third revision of the design, paying greater attention to the attachment of the walls to the trailer. We could have also saved some time and money by welding steel bars to the trailer frame, which would then tie into the walls. Instead we have bolts which tie the 2" x 6" and plywood subfloor to the steel trailer frame and lag bolts and steel straps which tie the subfloor to the walls.

General Conclusions: An important collective conclusion to be drawn is that people are essential to the success of any endeavor, and should be respected, thanked, and their generosity returned directly or indirectly, wherever and whenever possible. Complexity management immediately raised its mythic head during the project, appearing in many guises and contexts, including project scheduling, financial constraints, design uncertainties, sustainability-related tradeoffs<sup>35-44</sup>, cultural interactions<sup>45-66</sup>, and the ongoing need to cultivate improved communication and negotiation skills<sup>67-68</sup>. Winning friends and

influencing people, while maintaining personal integrity, should always be a priority. These project-based experiences provided the students with a valuable glimpse into the demands and rewards of the 'real world' by simply allowing them to create something real, make mistakes, correct them, and develop confidence. A case study in sustainable, small scale housing emerged in the process, one which can readily be reproduced in various forms. In addition, intellectual flexibility was found to be crucial to success due to the changes required during virtually every phase of the project.



Figure 13. Vagabond House loft & framing.

It is our intent that future capstone projects extend the reach and scope of current, experimental design/build activities to regional indigenous, underserved, and otherwise struggling people, ideally bringing hope, mutual respect, and opportunity into their lives by engaging them directly, via just-in-time theory and hands-on, experiential learning in designing and implementing their own homes and, in the long term, restoring regional landscapes.

Taliesin, the 6<sup>th</sup> century Welch warrior-poet and shapeshifter revered by architect Frank Lloyd Wright, offered an enchanting metaphor for achieving holism in Vagabond House and other creative ventures through experimental means. In *The Book of Taliesin*, compiled in the thirteenth century, Taliesin's ability to dissolve into a myriad of forms, die, and be reborn at will is revealed: "I was in many shapes before I was released," he said<sup>69</sup>.

Singer Joni Mitchell, in her counterculture anthem about the 1969 Woodstock Music and Art Festival, considered similar universals:

I came upon a child of God  
 He was walking along the road  
 And I asked him where are you going  
 And this he told me  
 I'm going on down to Yasgur's farm  
 I'm going to join in a rock 'n' roll band  
 I'm going to camp out on the land  
 I'm going to try an' get my soul free  
 We are stardust  
 We are golden  
 And we've got to get ourselves  
 Back to the garden

### **Bibliography**

1. Koestler, Arthur, 1964. *The Act of Creation*, London, Macmillan.
2. Grudin, Robert, 1991. *The Grace of Great Things: Creativity and Innovation*, Boston, Mariner Books.
3. Hadamard, Jacques, 1954. *The Psychology of Invention in the Mathematical Field*, New York, Dover Books.
4. Hyde, Lewis, 2007. *The Gift: Creativity and the Artist in the Modern World*, New York, Vintage Publishers.
5. Samples, Bob, 1993. *The Metaphorical Mind: A Celebration of Creative Consciousness, 2<sup>nd</sup>. Edition*, Rolling Hills Estates, California, Jalmar Press.
6. Williams, Daniel E., 2007. *Sustainable Design: Ecology, Architecture, and Planning*, New York, John Wiley and Sons.
7. Lyle, John Tillman, 1994. *Regenerative Design for Sustainable Development*, New York, John Wiley and Sons.
8. Mazria, Edward, 1979. *The Passive Solar Energy Book, Expanded Professional Edition*, Emmaus, Pennsylvania, Rodale Press.
9. Lechner, Norbert, 2009. *Heating, Cooling, Lighting: Sustainable Design Methods for Architects*, 3rd edition, New York, Wiley Publishers.
10. Dekay, Mark, and G. Z. Brown, 2014. *Sun, Wind, and Light: Architectural Design Strategies, 4<sup>th</sup> Edition*, New York, Wiley.
11. Wright, David 2008. *The Passive Solar Primer: Sustainable Architecture*, Atglen, Pennsylvania, Schiffer Publishing.
12. Wujek, Joseph, and Frank D'Agostino, 2009. *Mechanical and Electrical Systems in Architecture, Engineering and Construction*, 5th Edition, Upper Saddle River, New Jersey, Prentice Hall.
13. Grondzik, Walter T, et al. 2010. *Mechanical and Electrical Equipment for Buildings, 11<sup>th</sup> Edition*, New York, Wiley.
14. Messenger, Roger A., and Jerry Ventre, 2010. *Photovoltaic Systems Engineering, 3<sup>rd</sup> Edition*, Boca Raton, CRC Press.
15. Houghton, John, 2002. *The Physics of Atmospheres, 3<sup>rd</sup> Edition*, Cambridge, Cambridge University Press.
16. Houghton, John, 2009. *Global Warming: The Complete Briefing, 4<sup>th</sup> Edition*, Cambridge, Cambridge University Press.
17. Weisman, Alan 2010. *Gaviotas: A Village to Reinvent the World*, White River Junction, Vermont, Chelsea Green Publishing.
18. Susanka, Sarah, and Kira Obolensky 2009. *The Not So Big House: Expanded Edition*, Newtown, Connecticut, Taunton Press.
19. Benitez, Christina Paredes, and Alex Sanchez Vidiella, 2010. *Small Eco Houses: Living Green in Style*, New York, Universe Publishing.
20. Zeiger, Mimi, 2011. *Micro Green: Tiny Houses in Nature*, New York, Rizzoli International Publications.
21. Richardson, Phyllis, 2011. *Nano House: Innovations for Small Dwellings*, New York, Thames & Hudson.
22. Shafer, Jay, 2009. *The Small House Book*, Boyes Hot Springs, California, Tumbleweed Tiny House Company.



23. Kahn, Lloyd, 2012. *Tiny Homes, Simple Shelter: Scaling Back in the 21<sup>st</sup> Century*, Bolinas California, Shelter Publications.
24. Bell, Bryan, and Katie Wakeford, 2008. *Expanding Architecture: Design as Activism*, New York, Metropolis Books.
25. Architecture for Humanity, 2006. *Design Like You Give a Damn: Architectural Response to Humanitarian Crises*, New York, Metropolis Books.
26. Architecture for Humanity, 2012. *Design Like You Give a Damn (2): Building Change from the Ground Up*, New York, Metropolis Books.
27. Kibert, Charles J, 2012. *Sustainable Construction: Green Building Design and Delivery*, New York, Wiley.
28. Thompson, J. William, and Kim Sorvig, 2008. *Sustainable Landscape Construction: A Guide to Green Building Outdoors, 2<sup>nd</sup> Ed*, Washington, Island Press.
29. DesignBuildBLUFF Web Site: <http://designbuildbluff.org/>
30. Chaikin, Andrew, 1998. *A Man on the Moon*, New York, Penguin Books.
31. Oppenheimer-Dean, Andrea, and Timothy Hursley, 2002. *Rural Studio: Samuel Mockbee and an Architecture of Decency*, Princeton, Princeton University Press.
32. Rudofsky, Bernard, 1964. *Architecture Without Architects: A Short Introduction to Non-Pedigreed Architecture*, New York, Doubleday & Company.
33. Vitruvius, Ingrid Roland, and Thomas Howe, 2001. *Ten Books on Architecture (De Architectura)*, Cambridge, Cambridge University Press.
34. Box, Hal, 2007. *Think Like an Architect*, Austin, University of Texas Press.
35. Odum, Eugene P., and Gary W. Barrett, 2005, *Fundamentals of Ecology*, Stamford, Connecticut, Cengage Learning.
36. Odum, Howard T., 1971. *Environment, Power, and Society*, New York, Wiley Interscience.
37. Odum, Howard T., 2007. *Environment, Power, and Society for the Twenty-First Century: The Hierarchy of Energy*, New York, Columbia University Press.
38. Odum, Howard T., 1983. *Ecological and General Systems*, New York, Wiley.
39. Odum, Howard T., and Elisabeth C. Odum, 2000. *Modeling for All Scales*, New York, Academic Press.
40. Odum, Howard T., and Elisabeth C. Odum, 2001. *A Prosperous Way Down: Principles and Policies*, Boulder, University Press of Colorado.
41. Hall, Charles A. S., and Kent A. Klitgaard, 2011. *Energy and the Wealth of Nations: Understanding the Biophysical Economy*, New York, Springer.
42. Meadows, Donella, Dennis Meadows, and Jorgen Randers, 2005. *Limits to Growth: The 30-Year Update*, White River Junction, Vermont, Chelsea Green Publishing.
43. Meadows, Donella H., 2008. *Thinking in Systems*, White River Junction, Vermont, Chelsea Green Publishing.
44. Naess, Arne, 1973. The shallow and the deep, long-range ecology movement. *A summary, Inquiry*, 16: 1, 95-100.
45. Hall, Edward T., 1976. *Beyond Culture*, New York, Anchor Books.
46. Hall, Edward T., 1995. *West of the Thirties: Discoveries Among the Navajo and Hopi*, New York, Anchor Books.
47. Iverson, Peter, and Monty Roessel, 2002. *Diné: A History of the Navajo*, Albuquerque, University of New Mexico Press.
48. Dobie, J, Frank, 2006. *The Voice of the Coyote, 2nd Edition*, Lincoln, Bison Books.
49. Farella, John R., 1990. *The Main Stalk: A Synthesis of Navajo Philosophy*, Tucson, University of Arizona Press.
50. Veltman, Joshua, 2001. *Nightway Yeibichai Songs and the Navajo Worldview*, Ohio State University, Ph.D. Candidacy Exam Essay.
51. Witherspoon, Gary, and Glen Peterson, 1995. *Dynamic Symmetry and Holistic Asymmetry in Navajo and Western Art and Cosmology*, New York, Peter Lang Publishers.
52. Sandoz, Mari, 2008. *Crazy Horse: The Strange Man of the Oglalas*, Bison Books.
53. Nerburn, Kent, 2002. *Neither Wolf Nor Dog: On Forgotten Roads with An Indian Elder*, 2<sup>nd</sup> Edition, Novato, California, New World Library.
54. Lame Deer, John Fire, and Richard Erdoes, 1994. *Lame Deer: Seeker of Visions*, New York, Simon & Schuster.
55. White Hat, Albert, 1999. *Reading and Writing the Lakota Language*, Salt Lake City, University of Utah Press.
56. White Hat, Albert, 2012. *Life's Journey: Zuya*, Salt Lake City, University of Utah Press
57. Campbell, Joseph, 2008. *The Hero with a Thousand Faces*, Novato, California, New World Library.
58. Roberts, J.M., and Odd Arne Westad, 2013. *The History of the World*, Oxford, Oxford University Press.
59. McLuhan, Marshall 1971. *Understanding Media: The Extensions of Man*, Cambridge, MA, MIT Press.

60. Farrell, John A. 2012. *Clarence Darrow: Attorney for the Damned*, New York, Vintage.
61. Nisbet, Matthew C., and Chris Mooney, 2007. *Framing Science*, *Science*, Vol. 316, p. 56.
62. Orr, David, 2004. *Earth in Mind: On Education, Environment, and the Human Prospect*, Washington, Island Press.
63. Livin' Tiny: A Quest for Powder, <http://www.youtube.com/watch?v=q4U7isvtCHA>
64. Wilson, Edward O., 2012. *The Social Conquest of Earth*, New York, Liveright Publishing Corporation.
65. Snow, C. P., 2012. *The Two Cultures*, Cambridge, Cambridge University Press.
66. Mau, Bruce, 2004. *Massive Change*, London, Phaidon Press.
67. Gibb, Jack, 1991. *Trust: A New Vision of Human Relationships for Business, Education, Family, and Personal Living*, Hollywood, California, Newcastle Pub. Co.
68. Weinhold, Barry K., 1979. *Transpersonal Communication*, New York, Prentice Hall.
69. Guss, David M, 1985. *The Language of the Birds: Tales, Texts, and Poems of Interspecies Communication*, San Francisco, North Point Press.

## **An Outline for a Practical Course in Computer-Aided Design and Analysis in Civil Engineering**

David Naish

California State University, Fullerton

### **Abstract**

More and more, entry level engineers are expected to have proficiency or a working knowledge in multiple design/analysis programs. Mechanical engineering curricula tend to have courses devoted to learning specific software. However civil engineering curricula rarely include courses in software beyond AutoCAD and Matlab, instead focusing on learning software when needed in specific courses. A course in computer-aided design and analysis in civil engineering has evolved over the past few years to meet the changing demands of the workplace. This course now incorporates learning practical engineering software and developing students' ability to learn new software in an efficient manner. Students are taught the importance of fundamental theory beyond rote memorization of the mechanics of the software implementation. Additionally, students are taught to investigate multiple solution methods for similar problems and choose the most efficient method. The course concludes with a project aimed at allowing students to learn new software on their own, quickly and efficiently. The purpose of this paper is to outline the basics of this course to show that its modular nature can be easily incorporated into any curriculum or into individual courses.

### **Course Structure**

EGCE 432 is titled "Computer-Aided Design and Analysis in Civil Engineering." It has undergone various content changes over the past ten years. The focus of the course was originally based in learning and applying programming languages such as Fortran to engineering problems. It evolved over the years based on student and industry demand to include professional engineering software in addition to programming languages. Eventually it dropped the programming languages altogether and focused just on professional software. Currently the course focuses on learning various professional programs; but more so it focuses on how to learn various professional programs, a fact which is a subtle but important difference. Learning a specific engineering program does have value; however, the likelihood that every student will use the program taught in his/her future career is low. Therefore it is extremely important to spend time focusing on the important aspects underlying any program and its implementation to provide a foundation upon which to build. Specifically, one must have an understanding of: a) the background theory behind any program, and b) a structured approach to apply software to typically encountered problems. Each of these main focus areas is discussed in detail below.

The course itself is modular in nature. Each module focuses on one major program and lasts approximately four weeks with a practical exam at the end. This structure allows sufficient time to go into depth with the program, learning many different applications with both simple and complex examples. Also, this modular nature allows the course structure to fit into many different curricula (semester vs. quarter). The exclusive nature of the modules (once a module is finished, the new module is independent of the previous) allows them to be transplanted to any course given sufficient time.

*Background Theory.* First and foremost, it is essential to have a deep understanding of the background theory behind any engineering program. The old adage “junk in, junk out” is especially relevant as engineering software tends to allow those with minimal training and knowledge generate a large amount of analysis results. However, without the engineering judgment to understand the technical basis of the input and its effect on the output, those results should not be accepted blindly. To ensure that students are not simply trained as technicians to run software, the first lecture of each module is dedicated to understanding the theory behind that module’s program.

*Applications.* The majority of the module is spent applying engineering knowledge to analysis and design problems. It is important to emphasize here that not all problems are most efficiently solved using software, so students are taught to solve problems efficiently (i.e. sometimes it is faster and safer to solve a simple problem by hand than try to input all parameters, make all assumptions, and run the analysis correctly). Typically in the class, students look at solving three main types of problems: 1- simple problems best solved quickly by hand; 2- problems with simple, repetitive, but numerous calculations, best solved using either a spreadsheet or algorithmic approach; and 3- more complicated problems that are most efficiently solved using engineering software.

To ensure uniformity and applicability to subsequent problems, students follow a structured series of steps for each problem. These steps are defined simply using key words meant to be easily remembered and are not rigid, meaning that they can be rearranged as needed. They are simply meant to give some structure to every problem, as working with software, especially when unfamiliar with the interface, can be intimidating. These steps are discussed below. They are contained in two main phases common to any engineering problem: 1- Modeling, and 2- Analysis or Design.

#### *Phase 1: Modeling*

1. **Gridlines:** The purpose of this first step is simply to layout the gridlines that identify major features of the project. While gridlines themselves may not be necessary for every type of problem, it is a simple term to remember and is indicative of the broader goal of defining the scale and outermost limits of the project.
2. **Geometry:** This step focuses on laying out the specific features of the project. In a structural engineering project, this step could be simply drawing the columns and beams. In a hydrology problem, it could be laying out the path of a river or the locations of reservoirs.
3. **Restraints:** The third step aims to impose any conditions on the behavior of the system. This could be as simple as defining a pinned support for a beam.
4. **Properties:** The purpose of this step is to define the known characteristics of the system. For example, this might include specifying the material properties or a known beam size that will be used.
5. **Demand:** This last step is the most often forgotten step and its purpose is to place any demands on the system. In structural engineering problems, this step defines the loads applied to the structure. In a hydrology problem, this step could be to define a storm that will cause rainfall on a watershed.

*Phase 2: Analysis or Design*

1. Run: A simple name is provided for a simple step. In most software applications, this step is called “Run Analysis.” When solving a problem by hand, this is of course the step with the most work as the purpose of this step is to perform all calculations.
2. View: Viewing the results is an important step. Engineering software rarely limits the amount of output produced. Knowing how to view and present only the desired results is essential.
3. Process: The final step is to process the data, perform any iteration on the design if necessary, and interpret the results. The important thing to take from this step is that any results taken from a computer model need to be scrutinized. Applying engineering judgment is crucial at this point as it is very easy to take computer printouts as accurate if one is not careful.

Each time a new program is introduced in the class, a tutorial following the solution of a simple problem is used to go through the basic structure of the program following the steps shown. A sample of one tutorial is provided in the appendix. Note that despite the seeming simplicity of the problem and tutorial sheet, the in-class completion of the tutorial typically takes ninety minutes. This is due to the fact that not every single detail is provided on the tutorial sheet, which provides mainly a backbone for the solution. The instructor uses the simple outline and the students fill in the pertinent details as they go through the problem in class.

*Practical Examination.* At the end of each module, a practical examination is administered. The purpose of the exam is to test students’ understanding of the topic of a given module and their ability to efficiently solve engineering problems using a wide array of tools. A typical exam may include three questions for example, all of which can be solved using any tool, but each of which is most efficiently solved using one tool (i.e. one is best solved by hand, one is best solved using a spreadsheet or algorithmic approach, and one is best solved using the engineering program). As it is a practical exam, all students have access to a computer during the exam. This can present opportunities for academic dishonesty. Several techniques are used to help combat this problem including but not limited to the following: 1- multiple versions of the exam are administered; 2- LanSchool software is used to monitor student activity; 3- students must submit their completed analysis in addition to specific answers. Each of the above techniques has helped to catch students trying to gain an unfair advantage during exams.

**Project**

The course culminates in a final group project in which students apply their knowledge gained over the term of the semester to a new program with which they have not worked. The purpose of the project is multifold. First, it is meant to simulate a situation that everyone will likely encounter in their future engineering careers. Specifically, they will be expected to learn new engineering software to solve a problem without dedicated training or help. Second, it is meant to allow students to synthesize and apply knowledge gained in their other courses. Specifically, the majority of work throughout the semester is focused on structural engineering applications; however for their final project, students are not allowed to work with structural engineering software. Therefore they must utilize knowledge from their other courses. Third, it allows students to think outside the box in that they must devise their own problem to solve using the software. The majority of classes focus on solving given problems, but an important aspect of engineering knowledge and judgment is the ability to think creatively, a fact which is difficult in

the rigid confines of a traditional course. Fourth, the project aims to help develop students' presentation skills.

Students work with the professor to determine an appropriate program to use based on their interest. For example, a student group that is interested in geotechnical engineering might choose a program dealing with slope stability while a group interested in hydraulics/hydrology might choose a program focusing on analyzing flow through pipe networks. The program must be relevant to an area within civil and environmental engineering and must be capable of solving engineering problems, namely analysis or design problems. This fact implies that drafting software is not appropriate for this project as its main purpose is drawing. The project submittal consists of four main graded parts: the written report, the tutorial, the sample assignment, and the presentation. Each part is discussed in detail below.

*Written Report.* The written report is an organized summary of the important lessons from the project. Students organize and present the pertinent details of the program they have studied. Specifically they focus on the advantages and disadvantages of the program, any limitations on the analysis/design capacity, the background engineering theory, the software tutorial, and solved example problems.

*Tutorial.* Students create a tutorial, similar to those used during the course, to go through a simple example and show off the features and operation of their chosen engineering program. The purpose of the tutorial is to allow students a chance to learn new software from scratch and teach it to the class, as well as to give all students a database of tutorials that they can access later in their careers. Having a simple tutorial to remind oneself of the major features of a program is extremely convenient if one has to learn a program rapidly.

*Sample Assignment.* Students are asked to devise a sample problem or set of problems to solve using the software. As discussed above, one of the main purposes of this is to have the students think outside the box. They are used to being given a problem and solving that for given quantities. Having students create a problem makes them think about what can be solved and what is necessary to be able to solve that problem using their software.

*Presentation.* Because one of the best ways to learn something is to teach it to others, the students are tasked with teaching their chosen software to the class in a 30-40 minute lab session. They are given free rein to structure their lesson as they see fit. This fact allows students the opportunity to develop organizational skills as well as their presentation skills. Typical lectures incorporate the use of PowerPoint, board work, and direct application within the software. The majority of groups tend to divide up the lecture between the different aspects (i.e. one person gives background information, one person goes through theoretical calculations, one person does an example in the software itself, etc.). The truly great student presentations showcase the knowledge of each member equally by having them dynamically hand off the presentation to one another with seamless transitions.

### **Student Reception**

Prior to its current incarnation, EGCE 432 focused on using and applying multiple civil engineering programs. More specifically, it focused on micro-, macro-, and system-wide

applications. The content was delivered in much the same manner, but the term project focused just on applying the few programs discussed in class to a large-scale problem. The majority of student criticism stemmed from the fact that the course was essentially another design course, of which they already had many. They did learn software and apply it to problems, but they solved similar problems in other courses as well. Additionally, this led to the course only focusing in one area, a fact which caused many to wish for a more broad covering of topics.

With the shift to a focus more on learning how to learn to use software, rather than just the use of specific programs, came a dramatic improvement in student opinion of the course and its usefulness in the long-term. It also led to better appreciation of the need for life-long learning due to its incorporation of a tutorial-based project. Because students were able to use software in any area of civil engineering, those who would previously have commented on the one-note nature of the course noted the broad knowledge gained. Additionally students noted their appreciation for the fact that they could draw on their knowledge gained in other courses and apply them to new problems.

### Conclusions

In summary, this paper presents an outline of a course in computer-aided design and analysis focused specifically within civil engineering, although any discipline could incorporate the course in its curriculum. The purpose is not to analyze or assess the course quantitatively. The modular nature of the course makes it particularly appealing as it can draw from multiple subdivisions (focus areas) within civil engineering without negatively impacting the depth achieved in the course. Focusing on developing a patterned approach is an effective way to ensure that learning new software in the future is a relatively painless experience.

## Appendix: Sample Tutorial

### Lab Tutorial 1. Truss Analysis using SAP2000

Initial values:  $A=0.05 \text{ in}^2$ ,  $E=400 \text{ ksi}$ ,  $H=4 \text{ in}$ .

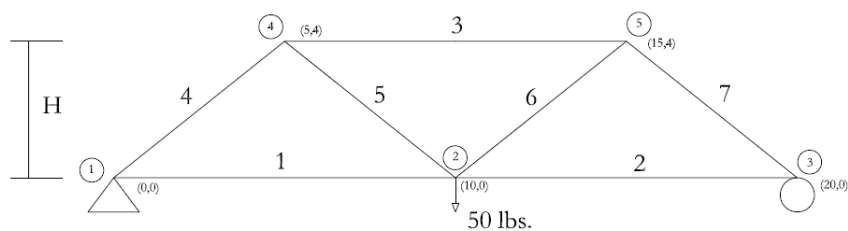

### Modeling Phase

#### Gridlines

- 1) Create grid for desired truss layout. (This is where we lay out the scale of the project)

X → \_\_\_ lines @ \_\_\_"  
 Y → \_\_\_ lines @ \_\_\_"  
 Z → \_\_\_ lines @ \_\_\_"

#### Geometry

- 2) Draw special joints at nodes 1-5.
- 3) Draw frame/cable elements for members 1-7.

### Restraints

- 4) Assign joint restraints for simple-support. We want to restrain motion in the x,y,z directions for the left-joint, and motion in the y,z directions for the right joint. (We are assigning the boundary conditions for the problem)

### Properties

- 5) Define → Materials → Add New Material
  - name
  - Modulus of Elasticity/Poisson's Ratio
- 6) Define → Frame Sections
  - Add I/wide flange *or* Add box/tube *or* Add general member
  - Add new property
  - then modify properties to match our set member dimensions
  - if we want to make sure these are truss bars, we should set the bending rigidity (EI) to be zero
- 7) Assign → Frame/cable/tendon → Frame sections
  - Choose desired section from list
  - Must have clicked on desired member to assign section

### Demand

- 8) Define → Load patterns
  - Choose load name (ie. 'point', 'type 1', etc.)
  - type 'dead'
  - Add new load
- 9) Assign → joint loads → forces
  - Choose load pattern name
  - Check units
  - apply load in z-direction
  - must have clicked on desired node

### *Analysis Phase*

#### Run

- 10) Analyze → Run analysis
  - Choose desired loading cases
  - Click run now

#### View/Process

- 11) View Results
  - This is where we can process the data from the structure.
  - We can view the results either in tables or on figures



## **A Service-Learning Collaborative Project in a Mechanical Engineering Technical Writing Class**

Stephanie Nelson and Brittany McCrigler  
California State University, Los Angeles/ iFixit

### **Abstract**

In collaboration with iFixit, a company that describes itself as “a global community of people helping each other repair things,” Cal State LA mechanical engineering students taking an upper-division technical writing class designed and wrote repair manuals for older model cell phones and PDAs. The students worked in groups to photograph the procedures and write the repair steps. Then the groups “user tested” and edited each other’s procedures before ultimately publishing them on iFixit’s website. iFixit provided the cell phones and PDAs, along with lights for the camera work and toolkits to open and access the devices’ components. During an initial classroom visit, a company representative showed the class a video of indigent scrappers working in an electronics waste site in Ghana, West Africa, where electronics, which contain many toxic and environmentally harmful substances, from the United States and elsewhere are dumped. The video showed local scrappers burning off plastics and other materials to retrieve copper and other metals. The video was sobering and inspired students to teach others to do simple repairs of these devices in order to extend their lifespan. iFixit is based in San Luis Obispo and was co-founded by two Cal Poly San Luis Obispo engineering students in 2003. The company is interested in collaborating further with engineering students to document repair procedures, many of which are deliberately not documented by manufacturers. Their motto is “right to repair.” Student feedback on the project was highly positive and students can now claim authorship on their resume of a published repair guide as well as service-learning credit. Students expressed a sense of pride in having contributed to iFixit’s global mission to “fix the world, one device at a time.”

### **Introduction**

In the spring quarter of 2011, having previously been approached by a representative of iFixit, a company dedicated to empowering users to repair things in order to extend their useful lifespans, Stephanie Nelson conducted a service-learning project with her 21 mechanical engineering students in an upper-division technical writing class. The students worked in groups to document simple repair procedures for older cell phones and PDAs that were provided by iFixit. Students then did user-testing to validate and correct as necessary one another’s repair guides. A company representative came to the class before the start of the project and explained the rationale for empowering people around the globe to learn to repair their devices in order to extend their lifespan, which was extremely motivating for students. He also provided students with many of the materials they needed to write repair procedures and a clear template with which to document their repairs and ultimately publish them on iFixit’s website. Student response to the project was overwhelmingly positive and the course evaluations were well above the department norm—even for the dreaded technical writing class! As one student remarked, “This was a great project to work on regarding iFixit. I really enjoyed the class and the group work.” Students expressed a sense of pride in their work and appreciation that they can now take credit for a service-learning project and a published document on their resume.

The representatives of iFixit are anxious to collaborate further with other technical writing classes in California and around the nation to extend the company's mission. As Brittany McCrigler, Director of Education Services for iFixit, states, "I believe that technical writing can truly change the world."<sup>1</sup> Since ABET has identified the lack of writing skills of graduating engineering students as an area needing significant improvement, this collaboration between engineering educators and iFixit's own technical writing department shows great promise in providing a solution to the global problem of e-waste while helping student develop critical skills in technical communication.

### **Background of iFixit**

iFixit was founded in 2003 by two Cal Poly San Luis Obispo engineering students after one of them dropped an iBook and wanted to repair it. Realizing there were no repair manuals or repair parts available, and learning that Apple strongly discouraged such attempts by users and instead suggested simply replacing the entire device, these students set out to repair the device themselves, and after many struggles, successfully did so. Kyle Weins, CEO of iFixit, and Luke Soules, the company's CXO, co-founded their fledgling business and based its profitability upon selling parts and tools needed to enable the repair of devices that manufacturers do not see fit to provide.

Some 10 years later, iFixit, based in the San Luis Obispo, a town on the central coast of California, employs nearly 40 people (with a large additional student internship base) and has a successful business model, having grown at the rate of about 50% a year for the past 4 years. More importantly, the company has published more than 10,000 internet-based, free-access repair procedures and "teardowns" (disassembly and evaluation of device components) for common devices from manufacturers that often don't allow user access to their documentation. These teardowns also include a reparability score, assessing how easy a device is to repair, so that consumers can make an informed decision about the devices they purchase. The company boasts a global user base of nearly 40 million website users a year and the website is published in four languages.

In our "throw away" and "get the next latest and greatest" consumer culture, iFixit stands out in its mission to keep these devices out of landfills and in the hands of their consumers longer. Their rationale for doing so is more fully described below.

### **iFixit's Rationale: Stemming the Global Tide of e-Waste**

According to the Environmental Protection Agency,<sup>2</sup> e-waste is expanding at the rate of 5-10% a year. A study of e-waste by MIT professors Duan et al.<sup>3</sup> predicts that e-waste will multiply by 33% in the next 4 years to more than 65 million tons a year. As Duan and others have stated, our collective desire to possess the next new gizmo, coupled with our predilection to dispose instead of mend what we do possess, leads us to throw things away at an increasingly rapid rate. Over 400 million electronic devices are discarded annually, according to the EPA—160 million in the U.S. alone. Cell phones are recycled at a rate of only 8%, and laptops at a rate of 25%.<sup>2</sup> But environmentally, when it comes to throwing things away, there is really no such thing as "away." Discarded electronics account for 40% of the lead found in landfills.<sup>4</sup> A single discarded CRT contains about 10 pounds of lead. In addition to lead, electronic devices contain toxins such as

arsenic, mercury, phthalates, dioxins, cadmium, antimony, and poly-brominated flame retardants, many of which will find their way into water supplies over time.<sup>5</sup> Not only do these devices contain toxins, but their components use mineral resources that are increasingly becoming scarce and are often mined at great environmental expense and via unethical and coerced labor practices. For instance, tungsten, used to make cell phones vibrate, is designated as a “conflict mineral,” similar to “blood diamonds,” due to the coercive and dangerous conditions under which it is mined in the Congo.<sup>1</sup> “Average cell phones contain more than 50 different elements,” states Brittany McCrigler. “That’s nearly half the periodic element table, and only a few are extractable once that phone reaches the end of its service life.”<sup>1</sup> Nearly 2 million new cell phones were manufactured in the U.S. in 2012. American users keep their cell phones on average only 18 months.<sup>6</sup>

In other words, manufacturers are using nonrenewable resources to make short-lived devices, and the U.S. is currently the world’s largest market for new electronic products.<sup>7</sup> And according to Kyle Weins, iFixit’s CEO, the U.S. also tops the charts of e-waste generated per person at a staggering 65.5 pounds per person per year.<sup>8</sup> Yet “designing for the dump” remains a profitable tactic for electronics manufacturers, even though there is no strategy currently in place for safely disposing of e-waste. Due to tough EPA restrictions for disposal of e-waste in the U.S., much of it ends up offshore. Over 100 million tons of e-waste is exported from the U.S. and Europe each year.<sup>8</sup>

So what happens to the majority of devices that we discard? Due to environmental waste and scrapping cost constraints in the U.S. and other first-world nations, much of it is shipped to third-world countries, often under false pretenses of being “recyclable.”<sup>5</sup> Recipient countries include Ghana, Nigeria, India, and China, where e-waste is mined for its useful minerals, often at great environmental and personal health expense. An average computer contains about \$6 U.S. dollars of recoverable metals, including trace amounts of gold, as well as copper and aluminum. Accessing these assets often involves burning away the plastic and other elements that surround them, releasing dioxins into the air and leaching other toxins into the soil. Yet the e-waste industry, largely employing children between the ages of 11-18 in Ghana, is growing in that country alone by about 20% a year.<sup>5</sup>

### **What Engineering Technical Writing Students and Faculty Can Do**

Apple Computers tells its users that the battery in its mp3 players isn’t serviceable. Yet 20 minutes of work and \$10 worth of materials can make an iPod with a non-functioning battery as good as new. One of the services iFixit provides is to publish “teardowns” on its website. The company purchases a new device, such as a Mac Pro, then takes it apart and documents what’s inside the “black box” as well as rates the device on its ability to be repaired, giving it a score from 1 to 10. Is that new iPhone glued together with epoxy? How hard does that make it to disassemble? (Harder, but not impossible by any means.) These scores help to inform consumers about how repairable the devices they choose to purchase will be, should they ever break.



Figure1. E-waste burning at a Ghana dumpsite to extract saleable elements<sup>5</sup>

iFixit values engineering faculty and students for a number of reasons. First, faculty and students are potential game-changers who can be a part of a culture shift that can challenge manufacturers to become more socially responsible and reconsider the planned obsolescence of many of their products. We can be voices of change, to the designers, engineers, manufacturers, as well as to the consumers who purchase these devices. Second, we can instruct and encourage our global community to recycle and repair the products we currently have. Engineers are born tinkerers, after all. Just because your cell phone or laptop doesn't come with a repair manual from the manufacturer doesn't mean you can't take it apart and write one of your own, then post it on the internet for everyone to use. Students can create something real and tangible that empowers people on a global level. No one person knows how to fix everything, but by combining our knowledge we can teach people how to fix anything. The average student-authored guide has over 3,000 views after just 6 months of being published. Some have as many as 60,000 views. In the words of one engineering student who wrote a manual that was posted on iFixit, "Over 10,000 people have seen my repair guide, and I haven't even graduated from college yet."<sup>8</sup> Repairing is a green technology. It is also a consumer right. "If you can't fix it, you don't own it," states iFixit's CEO, Kyle Weins.<sup>8</sup>

### **How the Collaboration Works**

iFixit is currently partnering with 20 universities, whose students have to date authored approximately 4,000 repair guides, and the company is actively seeking to partner with more. Toward this end they have developed multiple strategies, interfaces, processes, and materials to make this collaboration easy and successful. The program is essentially turn-key and online. iFixit provides technical writing help via email as well and offers teacher training workshops on a regular basis.

"Are you just a slimebucket company trying to profit off the free labors of students?" posits one of the FAQs on the company's student-facing website. The answer provided to the FAQ is a joking "yes." But, the explanation continues, the guides that students create are open-source and free to the world for anyone to edit, much like the Wikipedia model. They will forever remain free and protected, and iFixit does not make a profit from hosting student-authored manuals.

Meanwhile, students have performed a global community service by providing a tangible product that incidentally looks quite good on a resume.<sup>8</sup>

Students in a technical writing class work in groups and either choose a device to document or iFixit will supply one. The company also supplies disassembly toolkits and a class toolkit, as well as lighting for photo shoots. Students register on the iFixit website and initially write a short proposal of deliverables and demonstrate that they have done enough research to verify that their project is new or can significantly improve existing product documentation. iFixit next provides four clearly demarcated milestones to develop the repair guides step-by-step, with checklists to ensure full completion of the milestones. The milestones guide students through creating a troubleshooting document, informational pages, and repair manuals, giving students the experience of creating a whole service manual. An important milestone is user-testing by another group in the class to ensure the accuracy and understandability of the repair guide. iFixit not only provides feedback and guidance for students, but provides a developed rubric for scoring student projects to the instructor. Upon completion of the project and company approval, iFixit publishes the repair guide to its website.

### Conclusion

In a world where the lifespan of electronics that consume a significant amount of nonrenewable resources is becoming shorter and shorter, having engineering students help accomplish iFixit's mission to "write a repair manual for everything" is beneficial to both the classroom and the environment. The authors hope that more engineering educators will take up iFixit's call to empower the world through technical writing, either by joining the program, or by building their own hands-on service-learning projects. The authors also advocate classroom discussion around the difficult issues surrounding the design, creation, use, and end-of-life of electronics. Finally, the authors encourage engineering educators to view technical writing as a critical skill that can enable everyone to fix the world, one device at a time.

### References

1. Personal interview, iFixit, San Luis Obispo, CA, 1/8/2014.
2. Wastes, Resource Conservation, Common Wastes and Materials, eCycling, U.S. Environmental Protection Agency, Nov. 14, 2012. <http://www.epa.gov/osw/conserves/materials/ecycling/faq.htm>
3. Duan H., et al., Quantitative Characterization of Domestic and Transboundary Flows of Used Electronics," *Solving the E-Waste Problem*, Dec. 2013. [http://www.step-initiative.org/tl\\_files/step/\\_documents/MIT-NCER%20US%20Used%20Electronics%20Flows%20Report%20-%20December%202013.pdf](http://www.step-initiative.org/tl_files/step/_documents/MIT-NCER%20US%20Used%20Electronics%20Flows%20Report%20-%20December%202013.pdf)
4. Eilperin, J., Dead Electronics Going to Waste. *Washington Post*, A04, Jan. 21, 2005. <http://www.washingtonpost.com/wp-dyn/articles/A24672-2005Jan20.html>
5. Poisoning the Poor: Electronic Waste in Ghana, *Greenpeace*, August 5, 2008. <http://www.greenpeace.org/international/en/news/features/poisoning-the-poor-electroni/>
6. Mountain of Waste, *Time Magazine*, accessed Jan 20, 2014. <http://content.time.com/time/photogallery/0,29307,1870162,00.html>
7. Bloodgood, L., et al., Used Electronic Products: An Examination of U.S. Exports, U.S. International Trade Commission, USTIC Pub. 4379, Feb. 2013. [http://producenten-verantwoordelijkheid.nl/uploads/pdf/research/2013%2002%2001\\_ITC\\_Used\\_Electronic\\_Products.pdf](http://producenten-verantwoordelijkheid.nl/uploads/pdf/research/2013%2002%2001_ITC_Used_Electronic_Products.pdf)
8. iFixit, accessed Jan. 20, 2014. [www.ifixit.com](http://www.ifixit.com)

## **Increasing Diversity in Technical Education: The Importance of Building Technical Capital**

Armineh Noravian and Patricia Irvine  
San Francisco State University

### **Abstract**

In spite of targeted efforts to expand diversity in the engineering workforce, only marginal improvements have been made in diversifying engineering education. Today, the majority of students who enroll and graduate with a bachelor's degree in engineering are white males. To meet the quantity and quality of engineers the nation needs, we will need to do two things. First, we must "tap all talent" — attract a broad group of individuals who are presently underrepresented in engineering. Second, we must restructure engineering education so that students experience early in their training what engineers do. Because over forty percent of all four-year engineering graduates began their introductory studies in the community college, pre-baccalaureate preparation has drawn close attention. Women, racial/ethnic minorities, and low income students are well represented in community colleges, but only a small number of these populations graduate with associate's degrees in engineering and engineering technologies. Research has shown that an interest in engineering as a career impacts persistence. Yet women and other underrepresented students are less likely than their white male peers to have been socialized to do hands-on activities or encouraged to use toys, tools, or gadgets that might promote their interest in engineering. The research question for this study is: What is the role of problem-oriented pedagogical strategies in increasing the diversity of students in technical education among community college students? In this paper, we argue that success in technology and engineering education requires technical capital, which is experience with "tinkering," manipulating tools, doing hands-on work, and knowing the process of solving problems that require technical solutions. Thus, to increase diversity in technology and engineering education and careers, programs should help students acquire technical capital. To understand how students might acquire technical capital, this study investigated the perspectives of students enrolled in technician level pre-engineering programs that incorporated well-structured and ill-structured problems at North-West Community College (NWCC). The findings suggest that scaffolding experiences – moving from very well structured problems to ill-structured problems – allow students to acquire technical capital, which can help them succeed in pre-baccalaureate engineering education.

### **Introduction**

"Engineering has a diversity problem" (p.74) <sup>1</sup>, causing national concern about the consequences and solutions to this problem. On the one hand, creative engineering solutions are a product of the diverse life experiences of people involved; without diversity, we miss out on understanding various constraints, and developing novel designs, processes, and products that better meet our societal needs <sup>2</sup>. However, the fact that the majority of students who enroll and graduate with an engineering degree are white males, it's unlikely that we can anticipate a change in diversity in the future composition of the engineering workforce <sup>3,4</sup>. To encourage a diverse engineering student population we must focus on the curriculum <sup>5</sup> and restructure engineering education so that students experience early in their training what engineers do <sup>6</sup>. Because over forty percent

of all four-year engineering graduates began their introductory studies in the community college<sup>7</sup>, pre-baccalaureate preparation has drawn close attention.

In this paper, we argue that success in technology and engineering education requires technical capital, which is experience with “tinkering,” manipulating tools, doing hands-on work, knowing the process of solving problems that require technical solutions, and learning to deal with ambiguity<sup>8</sup>. Thus, to increase diversity in engineering and engineering technology education and careers, programs should help students acquire technical capital. The research question for this study is: What is the role of problem-oriented pedagogical strategies in developing technical capital among community college students in advanced technological education?

To understand how students might acquire technical capital, this study investigated the perspectives of students enrolled in a two-year technician level program at North-West Community College (NWCC). In the first year, learning takes place in courses that incorporate projects with well-structured problems<sup>9</sup>, often with both a theoretical classroom and a lab component. In the second year, students engage in ill-structured problem<sup>9</sup> solving in their capstone projects that integrate the principles that students have learned during the first year and continue to master in the second year.

### **Literature Review**

To understand the role of problem-oriented pedagogies in the development of technical capital, this section reviews the literature about community college students characteristics, well-structured and ill-structured problems, and barriers that non-majority students face in STEM education.

*Community college students characteristics.* Community colleges bring nontraditional students into engineering, as over forty percent of all bachelor’s degree holders began their education in these two-year institutions<sup>7</sup>. However, the characteristics of community college students present certain challenges<sup>10,11</sup>. Women, racial/ethnic minorities, and low income students are well represented in community colleges, but only a small number of these populations graduate with associate’s degrees in engineering and engineering technologies. Statistics on two-year institutions indicate that 58% of the students in community colleges are women<sup>12</sup>, 40% are racial/ethnic minorities<sup>13</sup>, nearly 38% are first-generation college students, and 57% are independent students who came from families with a yearly income less than \$36,000<sup>13</sup>. However, only 0.1% of women, 0.4% racial/ethnic minorities, and 0.6% white students graduate with an associate’s degree in engineering and engineering technologies<sup>14</sup>. This indicates that studies are needed to understand how to help retain nontraditional students in these fields.

Students choose to attend community colleges for a variety of nonacademic reasons. The cost of attending a 2-year institution is below that of a 4-year institution and the close proximity to students’ homes allows students to live at home while attending college, further reducing the financial burden<sup>13</sup>. Furthermore, community college students are also likely to have dependent children or family, and be older than 24, and be balancing work, family, and school. In addition, some nontraditional students may also be academically underprepared<sup>15</sup>. Attending community college allows these students to learn skills that prepare them for industry jobs in a short time<sup>13</sup>.

Participants in this study who had families and who wanted to become financially independent were eager to obtain the skills needed to get a job. The program at NWCC was intentionally designed to help them do that.

*Barriers faced by underrepresented students in STEM education.* Underrepresented groups face certain challenges in STEM fields that their white male counterparts are less likely to experience. For instance, women and other underrepresented students are less likely than their white male peers to have been socialized to do hands-on activities or encouraged to use toys, tools, or gadgets that might promote their interest in engineering<sup>16</sup>. Research has shown that an interest in technical fields careers such as engineering impacts persistence, yet underrepresented students are less likely than white males to have experience in “tinkering” or manipulating tools that might spark such an interest<sup>17</sup>. Furthermore, first generation and low income community college students are underrepresented in engineering because they face barriers to entering and completing an engineering degree in four-year colleges<sup>11</sup>. Studies indicate that majority of engineering students come from at least a middle-class backgrounds<sup>18</sup>. Foor, Walden, and Trytten’s<sup>19</sup> study of a first-generation, economically disadvantaged female student indicated that class was an obstacle to her success and feeling of belonging in engineering. Students who come from such backgrounds are an “invisible minority” (p. 145)<sup>11</sup> and lack the middle-class cultural capital<sup>20</sup> needed to succeed. In this paper, we focus on what it takes to help students develop technical capital as a means to increasing diversity in community college students in technology and engineering fields.

*Ill- and well-structured problems.* In this study, we examine whether well- and ill-structured problems affect students’ technical capital. According to Jonassen<sup>9</sup> well- and ill-structured problems lie on a continuum. Where on the continuum a problem resides depends on the complexity of the problem, the clarity of the goals, the certainty of the criteria required to solve a problem, the prescriptiveness of the skills required, and the number of possible solutions. The characteristics of well- and ill-structured problems are described in Table 1 below.



Table 1. Characteristics of well- and ill-structured problems (pp. 68-69) <sup>9</sup>

Well-structured problems	Ill-structured problems
<ul style="list-style-type: none"> <li>• Present all elements of the problem</li> <li>• Are presented to learners as well- defined problems with a probable solution</li> <li>• Engage the application of a limited number of rules and principles that are organized in a predictive and prescriptive arrangement with well- defined, constrained parameters</li> <li>• Involve concepts and rules that appear regular and well-structured in a domain of knowledge that also appears well- structured and predictable</li> <li>• Possess correct, convergent answers</li> <li>• Possess knowable, comprehensible solutions where the relationship between decision choices and all problem states is known or probabilistic</li> <li>• Have a preferred, prescribed solution process</li> </ul>	<ul style="list-style-type: none"> <li>• Appear ill-defined because one or more of the problem elements are unknown <ul style="list-style-type: none"> <li>• or not known with any degree of confidence</li> </ul> </li> <li>• Have vaguely defined or unclear goals and unstated constraints</li> <li>• Possess multiple solutions, solution paths, or no solutions at all, that is, no consensual agreement on the appropriate solution</li> <li>• Possess multiple criteria for evaluating solutions</li> <li>• Possess less manipulable parameters</li> <li>• Have no prototypic cases because case elements are differentially important in different contexts and because they interact</li> <li>• Present uncertainty about which concepts, rules, and principles are necessary for the solution or how they are organized</li> <li>• Possess relationships between concepts, rules, and principles that are <ul style="list-style-type: none"> <li>• inconsistent between cases</li> </ul> </li> <li>• Offer no general rules or principles for describing or predicting most of the cases</li> <li>• Have no explicit means for determining appropriate action</li> <li>• Require learners to express personal opinions or beliefs about the problem, and are therefore uniquely human interpersonal activities</li> <li>• Require learners to make judgments about the problem</li> </ul>

Well-structured problems are defined as educational exercises to which a limited number and variety of rules and principles are applied, within set parameters, with pre- determined right or wrong solutions <sup>21</sup>. Ill-structured problems, on the other hand, use learning activities which might have numerous solutions and pathways to solutions, have few parameters, and which contain uncertainty or ambiguity about how they are organized and which solutions might be justified <sup>21</sup>.

NWCC designed their engineering technology program to incorporate both ends of the well- to ill- structured continuum. Students at NWCC were engaged in solving problems that resembled well-structured problem in their first year. During their second year, students worked on capstone projects that were on the ill-structured end of the continuum.

### Methodology

A mix of first and second year students from North West Community College (NWCC) participated in this study. Of a convenience sample of sixteen students who were present,

available and willing to participate, six were first-year students engaged in projects with well-structured problems and ten were second-year students engaged in projects with ill-structured projects<sup>22</sup>. To protect anonymity, the names of the community college and the participants have been changed to pseudonyms. This was a qualitative study in which data collected was from face-to-face interviews of students. The interview protocol included open-ended questions about students' experiences in various projects. First-year students were interviewed in pairs, as that was their preference, and each interview took approximately 45 minutes. Second-year students were interviewed individually and each interview took approximately 30 minutes. All interviews were conducted at NWCC, were recorded, transcribed verbatim, and thematically coded. Themes were then organized and integrated<sup>23</sup>.

The unit of study is the project. Projects capture the range of activities that instructors perceive are required to perform tasks and learn the course content. First-year students were asked to compare their experiences in two projects that were different from one another based on the degree to which their instructor directed their activities. Second-year students were asked to compare their experiences in a second year project and a first year project. This approach allowed us to understand whether, and if so, which aspects of students' experiences in well- and ill-structured problems affected students' technical capital.

The demographics of the participants reflected the program's and the county's demographics in which NWCC was situated. The students were white and from working class backgrounds. Only one of the participants was female; she was the only female in the entire program. Some students had entered the program from high school, while others entered the program after being laid off from work. To determine the level of structuredness of the problems that participants described, the descriptions were compared to the characteristics of well- and ill-structured problems in the literature, as described above.

### Findings

The findings are based on twelve projects described by sixteen students. Six are first-year projects and six are second-year projects. The first-year projects include a classroom and lab component, and resemble well-structured problems. The second-year projects are capstone projects and resemble ill-structured problems. Table 2 lists the projects students described.

Table 2. Projects described by students.

	<b>Project Names</b>
<b>1st year well-structured problems</b>	Boiler Programmable Logic Circuit (PLC) Principles of technology Electrical systems Electronics Pneumatics
<b>2nd year ill-structured problems</b>	Robot Arm Siemens Programmable Logic Circuit(SPLC) Heating, Ventilation, and Air Conditioning (HVAC) Automated Production Line (APL) Automated Guided Vehicle (AGV) Solar panel

In this section, we describe the categorization of projects according to students and students' reported experiences in their projects.

### **Categorization of Projects**

Students' descriptions were used to categorize projects based on the characteristics of well- and ill-structured problems shown in Table 1. These categories indicate that problems lie on a continuum, from well- structured on one end to ill-structured on the other. This finding is consistent with Jonassen <sup>9</sup>.

*Well-structured problem.* The Boiler was a well-structured problem. The classroom portion of the Boiler project provided students theoretical knowledge of boilers and the lab portion allowed them to look at various physical parts of a boiler. They were able to do a limited set of tasks with the boilers so that they would learn what they would be expected to do on the job.

The Principles of Technology was also a well-structured problem. Similar to other first year classes, it included a classroom component and a lab component. In the classroom, the students learned concepts of physics and in the lab they worked on problems such as measuring forces, angles, and momentum which would demonstrate the concepts learned in the classroom. In the lab, students followed explicit steps to reach a specific objective. They documented measurements and calculations in their lab books or worksheets, which the instructor signed off on to indicate completion of the specific lab session. The students received assignments and quizzes, and weekly homework.

*Well-structured problem with a less-well-structured component.* Similar to the Principles of Technology, in the Electrical Systems and the PLC projects students learned theoretical concepts in the classroom and applied them in the lab to augment their learning from the classroom. But in contrast to Principles of Technology, the Electrical Systems and the PLC projects included components that were less well-structured. The lab component included wiring up a circuit to perform a specific task explicitly defined by their instructor. If the circuits did not perform as required, students had to understand where they had made a mistake and go through the process of debugging to find and fix the problem. This debugging process was what students found challenging and rewarding. Thus, the mistakes became the problems that they ultimately solved. The mistakes made were not predictable and finding and fixing the mistakes added a less well-structured component to the well-structured problem that was initially their task in the lab.

*Well-structured problem with ambiguity.* In the electronics project, students learned basic principles associated with electronics parts in the classroom, but in the lab they had to figure things out on their own. Students described an instance where they had to test transistors to see if they were functional or damaged. This meant that they had to learn about tools such as multi-meters, do research to collect data on transistors, and test them with the multi-meters. This process required that students knew how to use the multi-meter for this specific application, as well as what kind of data they needed to collect to test the transistor and what readings indicated that the transistors were functional or damaged. There were no explicit directions from the instructor on how these tasks needed to be performed, which made each step in the process somewhat ambiguous. Checking to see if transistors worked would generally have required following certain sets of steps. However, lack of explicit directions on how to perform this

problem and lack of comfort with using the multi-meter made this process ambiguous and challenging. Thus, this project was less well-structured because of lack of explicit directions for students.

*Moving from well-structured towards ill-structured problem.* Among the well-structured projects, the pneumatics project started as well-structured problems during the beginning of the term, but became increasingly less well-structured as the term progressed. At the beginning of the term, students were given a circuit to build in the lab to perform a specific function. The steps for building a given circuit, testing it, and making sure that it functioned as specified were explicitly given to students by the instructor. However, the students were required to figure out the debugging of the circuit by themselves, which helped them develop debugging skills. Thus, much like the Electrical Systems and PLC projects, Pneumatics projects had well-structured problems with a component that was less well-structured at the beginning of the term. However, the problems given to students evolved into a less well-structured as the term progressed. At the end of the term, the final goal for the project was determined by the instructor, but the solution was determined by the students. The solution involved using concepts, rules and materials that students were learning in the classroom and was bound by the parts that were available to them on the pneumatics trainer. Thus, the solution path had become “vague”, increasingly ill-structured<sup>9</sup> as students learned more content and became more familiar with the processes required to solve pneumatics problems.

*Hybrid problem.* The Robot Arm was the first second-year project for the second year students. The project involved some coursework that was mainly used to support the lab sessions. In the lab, students programmed a robotic arm to do a variety of tasks such as moving pucks, judging the color of pucks, and sorting and stacking pucks based on their colors. Students used the manual for the robot arm to learn how to program the robot and control the robot’s sensors. Although the students had learned programming, the language required to program this robot was new. A programming language provides the user specific instructions that command the robot arm to perform specific tasks. Each instruction has a known outcome; it is explicit and unambiguous. As such, this part of the problem was well-structured.

At this stage in the program, the students were generally familiar with sensors, but they needed to look on the internet to learn how the sensors on this particular robot arm functioned. Based on the information they found about each sensor, the students would write the program so that the robot arm would do specific tasks before and after the puck hit the sensor. The information that the students found on the internet provided different options on how the sensors could be used, providing ambiguity to students’ task. The result was that different groups of students who were working on this project used their sensors in slightly different ways to perform the same task. The outcome was that they realized the sensors could be applied differently, i.e. different solutions existed for the same problem even when using the same component. Thus, in this project the process of using sensors, something students had done in the past in well-structured projects, became a more ambiguous task. Therefore, this part of the problem was not well-structured.

Programming the robot required the application of these instructions in a manner that the student believed would accomplish their goal. This process required that the students assembled a

sequence of instructions to control the robot arm's movements in specific ways. This part of the problem was not described in the manual and could be done in many different ways. This exercise allowed multiple approaches and provided space for creativity. After writing a program for the robot, the students then had to debug their program, which meant trying to figure out why things didn't work as they expected. This part of the problem was ill-structured and increased the challenge level for the students.

In summary, the Robot Arm was an example of a hybrid project. The project was well-structured in that the end goal was explicitly stated by the instructor. Learning the programming language was also well-structured because the programming language was explicitly defined in the manual. But, using the various sensors was less well-structured (or more ill-structured) because the sensors had characteristics that allowed them to be used in different ways. Lastly, programming the Robot Arm, i.e. writing a sequence of instructions to accomplish a specific goal, could be done in different ways, which made it an ill-structured portion of the problem. Thus, the first second-year project that students did at the beginning of their second year was a hybrid project and contained elements that were well-, less well-, and ill-structured.

*Ill-structured with a problem to solve.* The Automated Production Line (APL), Automated Guided Vehicle (AGV), the Solar Panel, and the Siemens Programmable Logic Circuit (SPLC) projects all had the characteristics of ill-structured projects. In the APL, students worked on a scaled model of a bottling production line. Bottles travelled on a conveyor, were labeled, capped and packaged. Students identified a problem with a part of the production line, which became their project. In the AGV, students worked on the hardware and software of a robot that simulated the automated robots used to move goods and materials in factories. The goal was to have the robot follow a guideline placed on the floor by the students. In the Solar Panel project, students designed a solar panel that tracked the movement of the sun across the sky throughout the year. Lastly, the SPLC allowed students to select any particular aspect of working with an SPLC and produce mechanical, electronics, or software for an SPLC trainer to be used to train students. What these projects had in common was that students selected what particular aspect of the problem they wished to address, decided how to address it, and produced a solution, with the instructor acting only as a guide. In all these projects, the process that students described reflected the characteristics of ill-structured problems, that is, the problem was not well understood initially, there were many ways of solving the problem, the solution was not certain, and there were different ways of evaluating the solution.

*Ill-structured without a problem to solve.* The Heating, Ventilation, and Air Conditioning (HVAC) project was a project where students learned, but not through solving a problem. Students worked in teams to learn about the entire HVAC system on their own from the manual. The instructor functioned as a resource for the students and answered questions if asked. The students had to be able to verbally answer a set of seven or eight questions at the end of the term that tested their knowledge of HVAC installation, maintenance, servicing, and troubleshooting. In this project, the end goal was for the students to learn about the HVAC and communicate like an HVAC technician. The manner in which students accomplished this end goal was entirely up to them. Thus, the team members navigated their way, not through directed activities, but through vaguely defined goals. There was no explicit understanding of how the end goal could be accomplished, except that they could accomplish it by working together. Thus, even though

there was no problem to be solved, this project had the characteristics of an ill-structured problem oriented learning approach with the problem being that they needed to become knowledgeable about the entire HVAC system so that they could answer the end of term questions, much like they would if they were speaking to a customer in the field.

In summary, what these categories indicate is that this community college technician program begins their first year students with problems that are on the well- structured end of the well- and ill-structured continuum <sup>9</sup>. Students are then exposed to a hybrid problem at the beginning of their second year and delve into ill-structured problems solving during the remaining part of their second year. This process allows the first year students to develop the content knowledge and experience that would need to deal with the technically sophisticated and ill-structured capstone problems in their second year.

### **Students' Experiences in their Projects**

First year students reported that they were comfortable with working on well- structured problems and they reported a sense of accomplishment if their well-structured problem had a component that was not so well-structured. For example, in the Electrical Systems and the PLC projects students learned aspects of trouble shooting and became more confident in their ability to find problems and solve them. Students also reported being comfortable solving progressively more ill-structured problems as they developed content knowledge and experience in a specific subject area. An example of this experience was the Pneumatics projects, where students began with well-structured problems in the beginning of the term and progressively solved more ill-structured problems as they acquired knowledge and experience with solving problems, working with their hands, learning about tools, and approaches to solving problems.

Depending on their technical capital, first year students' experiences differed when they worked on problems that had a degree of ambiguity. In contrast, in the Electronics projects where students were given a less well-structured problem or a problem with a degree of ambiguity, those who did not have the technical background or experience for solving such a problem became lost and confused, while those who had the technical background or experience to deal with a less well-structured problem were able to do so with more ease. Second year students transitioned from well- to ill-structured problem solving by beginning with a hybrid projects that had components that ranged from well- to ill- structured. However, all their other capstone projects exclusively involved ill-structured problems. Students reported their experiences in their projects as challenging, but highly rewarding. Students expressed a high level of interest and confidence in what they had accomplished at the end of their second year. A second year student expressed his experience this way:

We didn't necessarily learn any new material. It was more about using the knowledge we've already acquired through the program in a real world application... being able to come up with our own process and use the skills we learned to create that process.

Another second year student put it this way:

We have to use what we've learned in the past year and half [first year projects and the hybrid project with which they started their second year] and then also on how we've learned to look at things.

Both students were describing how they built on the content knowledge, process of problem-solving, and ways of approaching problems that they had learned in their well-structured projects during their first year and hybrid project with which they began their second year. Thus students' acquired knowledge and experiences prior to delving into ill-structured problems had provided them the skills necessary to tackle technically sophisticated and ill-structured capstone projects and to succeed.

### **Conclusion**

Learning troubleshooting, becoming more knowledgeable about content, applying that knowledge to solving less well-structured problems, becoming comfortable with approaches to solving progressively less well-structured problems, and gaining experience in solving problems that are somewhat ill-structured are all part of building the skills required for succeeding in the challenges provided by ill-structured problems. We define technical capital as the cultural competence acquired from tinkering experience ("practical familiarity with mechanical and electronic devices and appliances" (p.61)<sup>24</sup>), manipulating tools, doing hands-on work, knowing the process of solving problems and approaches that can lead to technical solutions, and knowing how to deal with ambiguity. These examples demonstrate that well-structured problems are useful as scaffolding to develop technical capital, without which students are not likely to make sense of what they do when presented with ill-structured problems. The students at NWCC developed technical capital progressively as they moved from well-, to not-so- well, to ill-structured projects.

Moving students from very well-structured problems to ill-structured problems allows students to gradually build the knowledge and skills that they need to deal with problems that are technically more sophisticated and ill-structured. Such a gradual approach provides students who do not have a background with doing hands-on activities or tinkering (technical capital) and experience in solving technical problems an opportunity to acquire it upon joining technical or engineering programs. Students in this study reported that technical content combined with the process of learning and applying knowledge to solve a problem was important. In fact, students saw processes such as planning, thinking in certain ways, learning how to learn on their own, and doing research as important as acquiring technical knowledge. These kinds of knowledge can best be acquired through working on both well- and ill-structured problems.

These findings indicate that to increase diversity in technology and engineering education, programs should be designed to build community college students' technical capital. Students who lack technical capital are likely to be women and underrepresented populations (students of color and economically disadvantaged students). Without technical capital, they are likely to find the experience of dealing with ill-structured problems confusing, difficult, and meaningless. Such a negative experience is likely to push them out of technology and engineering fields. On the other hand, building their technical capital will provide them the skill and experience that they need to succeed in these fields.

### **Acknowledgment**

This material is based upon work supported by the National Science Foundation under Grant No. DUE 1003589. Any opinions, findings, and conclusions or recommendations expressed in this

material are those of the authors and do not necessarily reflect the views of the National Science Foundation.

## Bibliography

1. Chubin, D., May, G. S. & Babco, E. L. Diversifying the engineering workforce. *J. Eng. Educ.* 94, 73–86 (2005).
2. Wulf, W. A. Diversity in engineering. *The Bridge* 28, 8–13 (1998).
3. National Science Foundation. Table 2-9. Undergraduate enrollment in engineering programs, by sex, race/ethnicity, citizenship, and enrollment status: 1999-2009. (2009) at <<http://www.nsf.gov/statistics/wmpd/2013/pdf/tab2-9.pdf>>
4. National Science Foundation. Table 5-7. Bachelor's degrees awarded, by race/ethnicity, citizenship, sex, and field: 2010. (2012). at <<http://www.nsf.gov/statistics/wmpd/2013/pdf/tab5-7.pdf>>
5. Busch-Vishniac, I. J. & Jarosz, J. P. Can diversity in the undergraduate engineering population be enhanced through curricular change? *J. Women Minor. Sci. Eng.* 10, 255–281 (2004).
6. King, C. J. Restructuring engineering education: Why, how and when? *J. Eng. Educ.* **101**, 1–5 (2012).
7. National Science Foundation. *Characteristics of recent science and engineering graduates: 2008*. (2012).
8. Noravian, A. (In review). How do well-structured projects influence the identities of technology students in community college? *Journal of Technology Education*.
9. Jonassen, D. H. Instructional design models for well-structured and ill-Structured problem-solving learning outcomes. *Educ. Technol. Res. Dev.* 45, 65–94 (1997).
10. McLoughlin, L. A. in *Eng. Soc. Justice - Univ. Beyond* (Baillie, C., Pawley, A. L. & Riley, D.) 123–142 (Purdue University Press, 2012).
11. Strutz, M. L., Orr, M. K. & Ohland, M. W. in *Eng. Soc. Justice - Univ. Beyond* (Baillie, C., Pawley, A. L. & Riley, D.) 143–156 (Purdue University Press, 2012).
12. National Center for Education Statistics. Table 205. Total fall enrollment in degree-granting institutions, by level and control of institution, attendance status, and sex of student: Selected years, 1970 through 2010. *Dig. Educ. Stat.* (2011) at <[http://nces.ed.gov/programs/digest/d11/tables/dt11\\_205.asp](http://nces.ed.gov/programs/digest/d11/tables/dt11_205.asp)>
13. Malcom, L. E. in *Underst. Community Coll.* (Levin, J. S. & Kater, S. T.) 19–35 (Routledge, 2013).
14. National Science Foundation. Table 4-3. S&E and S&E technologies associate's degrees awarded, by sex, citizenship, race/ethnicity, and field: 2010. (2010). At <<http://www.nsf.gov/statistics/wmpd/2013/pdf/tab4-3.pdf>>
15. Bailey, T. & Morest, V. S. *Defending the community college equity agenda*. (The Johns Hopkins University Press, 2006).
16. Heppner, R. S., Lee, R. S. & Wao, H. O. in *Becom. Eng. Public Univ. Pathw. Women Minor.* (Borman, K. M., Tyson, W. & Halperin, R. H.) 81–104 (Palgrave Macmillan, 2010).
17. Seymour, E. & Hewitt, N. M. *Talking about leaving: Why undergraduates leave the sciences*. (Westview Press, 1997).
18. Riley, D. *Engineering and social justice*. (Morgan & Claypool Publishers, 2008).
19. Foor, C. E., Walden, S. E. & Trytten, D. A. 'I Wish that I Belonged More in this Whole Engineering Group:' Achievin Individual Diversity. *J. Eng. Educ.* 96, 103–115 (2007).
20. Bourdieu, P. in *Power Ideol. Educ.* (Karabel, J. & Halsey, A. H.) 487–510 (Oxford University Press, Inc., 1977).
21. Jonassen, D. H. Designing for decision making. *Educ. Technol. Res. Dev.* 60, 341–359 (2012).
22. Coyne, I. T. Sampling in qualitative research. Purposeful and theoretical sampling; merging or clear boundaries? *J. Adv. Nurs.* 26, 623–630 (1997).
23. Bogdan, R. & Biklen, S. K. *Qualitative research for education: An introduction to theories and methods*. (Allyn & Bacon, 2006).
24. Mills, J., Ayre, M. & Gill, J. *Gender inclusive engineering education*. (Routledge, 2013).



## Assessment of Team Projects in an Electrical Power Systems Course

Bruno Osorno  
California State University, Northridge

### Abstract

With team-project-based courses the challenge has been assessment. Various attempts have been effective in one dimension and weak in another. Utilizing a different method, a comprehensive assessment of a team-project-course is discussed in this paper. In this 15-week course, two midterms, a final exam, and weekly 15-minute quizzes and homework assignments were administered in addition to five team projects. The relationship between students' self-reported participation level in the team projects and their grade in the exams was analyzed to assess the effectiveness of team projects in this electrical power systems course. The results of the regression analysis suggest that there is a mild relationship between students' participation level in team projects and their final exam grades. According to Bloom's paper the learning pyramid (Figure 1) indicates that we start with evaluation and end with knowledge, we can argue that the development of projects in tandem with exams and quizzes, induces students to go through all the steps indicated in the pyramid, many times without realizing the learning involved during the process. The realization occurs at the final exam, when students perform better and learned a lot more. This point will be discussed later in this paper.

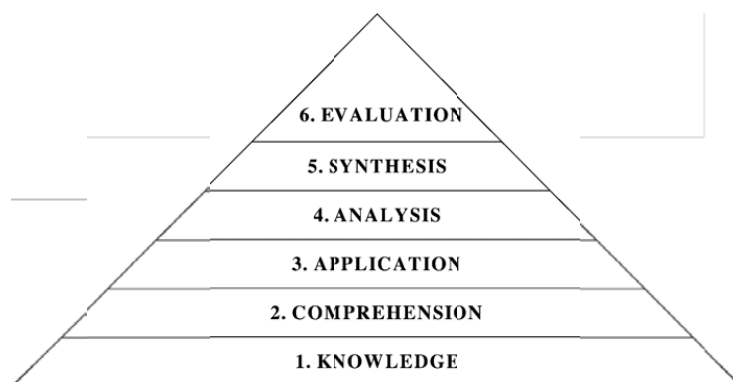

Figure 1. Taxonomy of educational objectives [4].

### Introduction

The course included five projects, each of which built upon the previous one. These projects were Matlab based where a power transmission line with shunt and series compensation had to be designed for 31 ASCR conductors. The first project was a very simple calculation: A three phase transmission line reactance. The second project was the calculation of the transmission line capacitive reactance. The third one was the calculation of the ABDC parameters for the transmission line. The fourth one was the calculation of the voltage ratio and voltage regulation. The fifth one was to include compensation when required according to constraints provided. The topics covered in the first three projects were assessed in the first mid-term exam; the topics covered in the fourth and the fifth projects were assessed in the second

mid-term exam. The comprehensive final exam assessed the topics covered in all five projects. Each project had a presentation component, after which individual students filled out online questionnaires related to their participation level in their project teams. The teams remained the same throughout the semester. Total number of students was 34 with three students in each team, except two.

A regression analysis was conducted to explore the relationship between students' participation level in team projects and the grade they received for the corresponding mid-term exam. Another regression analysis was conducted to assess the degree of strength for the relationship between the average participation level of students in their teams for all projects and their final exam grade. As expected the results show that those students who participated more in the team projects, performed better in the exams. The strength of this relationship is another evidence for effectiveness of team projects in engineering education.

### Procedure

Several papers [1], [2], [3] have tried to define and quantify “team projects,” utilizing different names such as “collaborative learning,” “project based learning (PBL),” etc. What is unique about this paper is assessing the relationship between student performance measures (exam grades) and quantitative measures of student involvement in the projects (participation level).

Below we indicate the timing and the closed loop of information that was created. After all, if we do not have feedback in the projects, the effort could have been less meaningful. Figure 2 shows the flow of activities and how the groups were moving along during projects. At the beginning of the semester groups were formed independently, that is, students choose their own team members. Three students per group were selected and the instructor did not interfere in this process. After the material for project 1 was covered, quizzed and homework related to the project were assigned and graded, project 1 was assigned and a deadline was given in mutual agreement with the class. Grades were given quite rapidly in order to maximize the feedback and at the same time several groups were selected to make a presentation (usually the best and worst project). The intention was to give ideas to students as to how to do the projects and learn from others. The instructor gave feedback to the entire class by making constructive comments to the presenters.

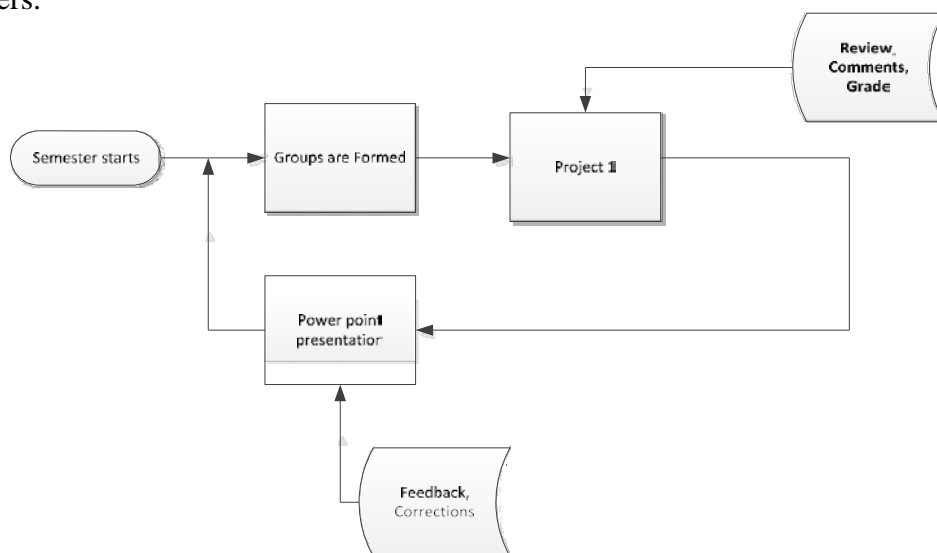

Figure 2. Visual timeline.

### Project Description

Teams were provided with handouts describing the projects with simple inputs and outputs and the format for the word document report. The five projects given were:

1. Inductive reactance
2. Capacitive reactance
3. ABCD parameters
4. % voltage regulation and voltage ratio
5. Inductive and capacitive compensation

The first three projects and first four quizzes were utilized to design the first midterm. The fourth and fifth projects and the remaining six quizzes were utilized the second midterm. The final exam was comprehensive, including all projects and all quizzes. The first quiz grades suggested that students with higher participation level in the team projects might be doing better in the quiz. Therefore, an online questionnaire was created to determine the contribution to the project of each team member.

### Questionnaire

This questionnaire was a tool to indicate that the student's effort was being rated by their own peers. The questions asked in the questionnaire were:

1. Please type your group's name (i.e. the cats or the fishes)
2. Type names of team members as team member 2 and team member 3 (i.e. Flash Gordon as team member 2 and Batman as team member 3, you are by default team member 1)
3. What was the percentage of your contribution to project 1 (from 0 to 100%)?
4. What was the percentage of team member 2's contribution to project 1 (from 0 to 100%)?
5. What was the percentage of team member 3's contribution to project 1 (from 0 to 100%)?

The last three questions of the project participation questionnaire allowed not only to include a student's level of participation as he/she perceived and reported it, but also to take into consideration the other two team members' perception of that student's participation level in their team. This unique approach to assessment of participation level in teamwork was useful for the analysis of the relationship between participation level in teamwork and academic performance.

### Analysis

For each student the average of their participation level for each project was calculated including their self-reported level of participation and their team mates' perception of that particular student's participation. After calculating these participation levels for every student and for each project, the relationship between the level of participation and the exam grades were assessed. The relationship between the average level of participation for the first three projects and the first exam was weak ( $r^2 = 0.04$ ). The relationship between the average level of participation for the last two projects and the second exam was also weak ( $r^2 = 0.02$ ). However, the relationship between the average level of participation in all five team projects and the final exam was relatively stronger ( $r^2 = 0.11$ ). Although these results do not suggest a causal

relationship, the strength of the third relationship mentioned above does suggest a potential influence of level of participation in team projects on exam grades.

### **Findings and Conclusions**

This study supports the argument in the literature that “Team Projects” [1], “Collaborative learning” [2], and “Project Based Learning (PBL)” [3] are indeed useful in engineering education. Although not all the relationships tested in this study turned out to be as strong as expected, the presence of a relationship and its direction are evidence for the effectiveness of project based learning in groups for better academic performance. One possible reason for the weakness of these relationships is the size of the class. Therefore, the instructor intends to continue applying this type of participation level questionnaire in the future courses to increase the cases included in the analysis. Another reason for the grades to reflect the effort put in the team projects only to a certain extent might be the anomalies observed in two groups. There were two groups where one team member put a big effort and the rest of the members did not. The consequence of this approach was that the individual that put this large effort became overwhelmed and had less time to prepare properly for exams and quizzes, thus compromising their grade through the examinations. The findings of this study suggests that assessment of the relationship between quantified measures of student participation in team projects and their academic performance requires more attention, since there is a potential positive correlation between them.

### **Bibliography**

1. “Experience of cooperative learning in engineering,” Rocio Maceirasa, Angeles Cancelaa, Santiago Urréjolab and Angel Sáncheza,, *European Journal of Engineering Education*, Vol. 36, No. 1, March 2011, 13–19.
2. “Collaborative Learning Techniques and their Extensions to Virtual Classrooms,” Paul S. Steif and Anna Dollár , 34th ASEE/IEEE Frontiers in Education Conference, October 20 – 23, 2004, Savannah, GA.
3. “Experiences of learning styles in an intensive collaborative course,” Satu Alaoutinen, Kari Heikkinen, Jari Porras. Published online: 21 August 2010, Springer Science Business Media B.V. 2010.
4. D. R. Krathwohl, B. S. Bloom, and B. Masia, *Taxonomy of Educational Objectives: The Classification of Educational Goals. Handbook II: The Affective Domain*. New York: David McKay Co., 1964.

## **Experience from a Faculty Exchange Program: Student Success Lessons from Cal Poly State University**

Andriani Parastiwi and Taufik Taufik  
Polytechnic State of Malang-Indonesia *and*  
California Polytechnic State University, San Luis Obispo

### **Abstract**

To increase faculty exchange activities at Indonesian universities, the Indonesian government has initiated a program called the Scheme of Academic Mobility and Exchange (SAME) wherein faculty from Indonesian universities spend some time visiting universities outside of Indonesia. This paper presents experience learned from a visit conducted by a faculty from state polytechnic of Malang Indonesia to Cal Poly State University. In particular, lessons learned by the faculty visitor on student success as a primary driver at Cal Poly will be discussed. Benefits observed from the visit will also be presented.

### **Introduction**

In today's increasing interconnectivity and diverse world, higher education institutions have to answer to the raising demand to internationalize their academic offerings to stay competitive in their national and global education markets. Internationalization is defined to be a process of integrating intercultural and global dimensions into the purpose and functions of the institution<sup>1</sup>. Many forms of activities have been proposed and implemented to ensure that internationalization can be achieved. Examples include student exchange programs, twinning programs, double-degree programs, and academic or research partnerships with foreign institution. Another effort that focuses on improving the overall quality of faculty's scholarship and teaching is the faculty exchange. The faculty exchange program has become popular because faculty qualification is a critical factor in enhancing the overall quality of higher education institution.

To increase faculty exchange activities at universities in Indonesia with their counterparts abroad, the Indonesian government has recently launched a program to fund Indonesian faculty to visit their research collaborator at universities outside of Indonesia. The program, called the "Scheme of Academic Mobility and Exchange (SAME)" program, aims to provide senior faculty to spend some amount of time at a university abroad to keep faculty up to date in their field and to expand their network. Academic activities that the faculty have to perform under the SAME program vary from writing textbooks, conducting collaborative research, doing comparative study on teaching & learning, to writing scientific papers. The State Polytechnic of Malang Indonesia (Polinema) has been participating in the SAME program with several universities. One of the universities that Polinema has been working with is Cal Poly State University in San Luis Obispo as the two universities have already signed a Memorandum of Agreement for academic exchange a few years ago which was renewed in 2013. One faculty exchange that occurred recently was a faculty from the electrical engineering department at Polinema visiting Cal Poly through the SAME program to conduct collaborative work with her counterpart in the electrical engineering department at Cal Poly. This paper describes the experience observed from this exchange activity focusing more on lessons learned to enhance students' success.

### Research Aim and Methodology

One of the activities planned during the visit to Cal Poly was to conduct collaborative research on renewable energy. Under the SAME program, research was commissioned to develop understanding of wider benefit to the faculty exchange program, to the country of faculty origin, to the host country of faculty exchange, and to investigate direct/indirect impact of the faculty exchange program. For the faculty visiting Cal Poly, the research methodologies used were literature study and total participation as a faculty exchange. During the 3 month visit, the faculty conducted several activities that can help her in preparing for her future research effort in renewable energy. Examples of such activities include conducting laboratory visits as shown in Figure 1, field trip to a large-scale Photovoltaic power plant, attending courses and technical seminars on campus, and interacting with students' clubs.

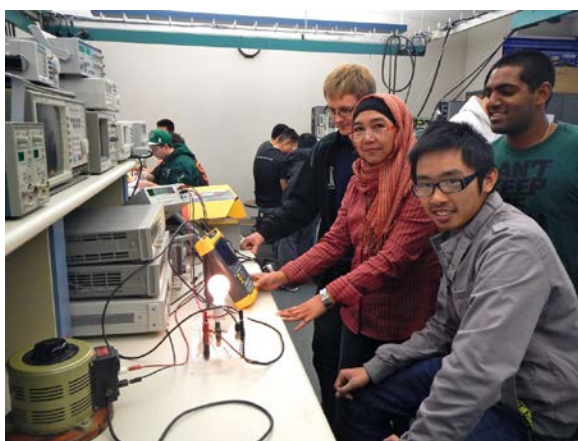

Figure 1. Visiting and observing students conducting power electronic lab experiment.

### Indonesia Higher Education and Faculty Exchange Program

Despite Indonesia's population of approximately 240 million, the number of young Indonesians attending college is relatively low. A report from the Indonesian Ministry of National Education's National Strategic Plan 2010-2014 cited the need to continue the work on increasing higher education access, particularly in some regions of the country<sup>2</sup>. Indonesia higher education institutions are mostly owned by private institutions. Out of 3,079 campuses nation-wide, only 82 institutions are state owned with student body of roughly 4.3 million. There are 5 types of Indonesian higher education institutions as seen in Table 1.

Table 1. Indonesia higher education institution.

No.	Higher Education Institution Form	Service Provided
1	Academies	provides only one particular applied science, engineering, or art
2	Polytechnics	provides applied/practical specific skills
3	Advanced Schools	provides academies or professional education in one specific knowledge
4	Institutes	consists of many colleges/departments on one knowledge discipline
5	Universities	offers training and research in various disciplines

As Table 1 shows, polytechnic is a form of higher education institution that provides specific applied/practical skills. Polinema falls within this category. As a higher education institution,

Polinema embraces internationalization as part of its mission and strategic plan. This is viewed to be significant as internationalization of higher education institution is considered a means to increase national competitiveness<sup>3,4</sup>. In this context, every higher education institution is expected to play a role with the support of the Indonesian Directorate General of Higher Education (DGHE) to improve national competitiveness as well as to prevent or minimize the possibility of negative effects from globalization. Government's support for internationalization come in various programs such as funding for international seminars/workshops, international scholarship, student exchange program, and faculty exchange program.

As previously mentioned, a faculty exchange program funded by Indonesia's DGHE is called Scheme Academic and Mobility Exchange (SAME). This program was first implemented in 2012. In 2013, the program continued with 68 faculties participating in the program. Each faculty is expected to participate in the program by visiting a university outside of Indonesia for the duration of 2 weeks to 3 months. Many different activities may be conducted during the visit: writing textbook or developing teaching material; sitting-in classes or comparative study of teaching and learning; planning collaborative scientific activities; doing research and writing scientific paper; attending and presenting a seminar; developing a curriculum, and observing teaching-learning techniques. One of the 68 faculties selected in the 2013 SAME program was from Polinema.

### **Cal Poly as a Host of Faculty Exchange with a Student Success Lesson**

Polinema is a polytechnic institution which started in 1982. At the time the country had a total of 8 state polytechnic institutions which has now grown to 30 state polytechnics. Polinema has been recognized nationally as one of the frontier polytechnic and one of the best engineering polytechnic in Indonesia. Polinema's curriculum follows the learn-by-doing philosophy which consists of 45% theory and 55% lab/project. The campus has 6,845 students with a student to faculty ratio of 17. In 2013, students' success rate in being hired right after graduation is 75.9%. Since 2008, Polinema has a memorandum of agreement with Cal Poly State University in San Luis Obispo (Cal Poly). During the past few years, a Cal Poly faculty has been visiting Polinema several to perform several academic activities including technical presentation, short courses, guest speaker, and judge for a national engineering competition hosted by Polinema. Table 2 summarizes some information on the two campuses.

Table 2. Cal Poly and Polinema.

No.	Information	Cal Poly	Polinema
1	Year established	1903	1982
2	Student Body	18,762	6,845
3	Student faculty ratio	22	17
4	Academic calendar	3 quarters/year	2 semesters/year
5	Type of institution	teaching institution	teaching institution
6	Accreditation institution	ABET (US)	BAN-PT (Indonesian)
7	Job recruitment	Carrier Service	Job Placement Center

Cal Poly with a student body of 18,762 and student faculty ratio of 22 has the "Mustang Way" pride slogan aimed to educate students with 5 strong characters:

1. Focused on excellence
2. Embrace one another

3. One community
4. Accept responsibility
5. Lead by example

These Mustang Way characters along with the learn-by-doing philosophy give a strong foundation for Cal Poly's pursuit of knowledge and scholarly achievement which continue to strengthen, enrich, and remains relevant to contemporary needs. Cal Poly also strives to create an atmosphere of mutual respect, celebrating the positive differences that make them unique. Personal commitment and participation in the Cal Poly community is the cornerstone of the Mustang experience. Students at Cal Poly are to support one another while also taking pride in accepting personal responsibility, thus strengthening the Cal Poly family.

In addition to the Mustang character and learn-by-doing philosophy, Cal Poly has student success as its primary driver. The student's success has been inspiring all the staff and faculty to serve students at their best with the belief that student success drives faculty and staff success, which is in turn nurturing a very positive academic atmosphere on the Cal Poly campus. Positive academic atmosphere has been proven to develop and inspire whole-system thinkers who can help solve society's most complex problems. One example of how student success can be achieved is by having the Career Service as a division of Student Affairs which is offering numerous workshops aimed to increase student potential. Academic departments within Cal Poly contribute to the student success through well-structured curriculum and well-equipped undergraduate teaching and research laboratories. Unlike in many research universities, the majority of labs are instructed by professors instead of graduate students. The university also recognized the importance role of student academic clubs in supporting both its learn-by-doing and multidisciplinary learning experience. Faculty are encouraged to get involved in applied research with companies within and around the central coast area. Being a comprehensive polytechnic university with six colleges, Cal Poly provides a distinctive niche in higher education, not just in California, but nationwide. These are the reasons Polinema chose Cal Poly as a host for the SAME faculty exchange. Upon returning to Polinema, the visiting faculty has proposed to her administration several changes on campus following the student success model she observed at Cal Poly. For example, more workshops and seminars should be offered by the career service at Polinema to help students improve their soft-skills and thus supports student success. More outreach activities coordinated by either each program or student club should be encouraged by the administration. Polinema should also continue the effort in upgrading their labs through state funding and industries.

Both the visiting faculty from Polinema and the host faculty at Cal Poly strongly believe that the faculty exchange program benefits both campuses. To Cal Poly faculty and students, the faculty exchange program provides the opportunity to learn how polytechnic schools outside of the US is structured. Recognizing and understanding the similarities and differences in the curriculum are also part of what have been learned from the visit. The following further lists the benefits gained from the faculty exchange activities<sup>5</sup>.

#### *Benefits of Faculty Exchange*

1. Career enhancement
2. English language proficiency



3. Cosmopolitanism and intercultural sensitivity
4. Personal growth and wider experiences both through on-campus activities and wider interaction with the host country society
5. Social benefit and networks by keeping contact using international network facilities

#### *Benefits of Faculty Exchange to Country of Origin*

1. Capacity building and societal development as a result of the professional activities, benefit of up-skilling and acquisition of new skills, to broader impacts within societal or economic development and capacity building
2. Personal multiplier effects where the impact through the professional activities

#### *Benefit of Faculty Exchange to Host Country*

1. Promoting trust especially in issue of mutual understanding and soft power
2. Host country influence during capacity building which will contribute to socio-economic development
3. Professional networks as potential professional networks offer the possibility of future business transaction and collaborations of economic values
4. Host country faculty and students have more knowledge about other country's socio, economic, and technology.

Several outcomes were achieved from the faculty visit to Cal Poly. These include co-authoring technical papers and book, collaborating on grant proposals, and planning for laboratory developments at Polinema.

### **Conclusions**

Faculty exchange programs including the one presented in this paper has demonstrated several tangible benefits as it relates to faculty's capacity building and networking, personal growth, and potential future transaction or collaboration. With today's era of globalization, the demand for internationalizing higher education has increased and will continue to be so. Faculty exchange along with other programs will help universities achieve this goal.

### **Acknowledgement**

Special thanks to the Directorate General of DIKTI for providing the financial support for the faculty visit SAME program to Cal Poly State University. Thank you also to all of Cal Poly faculty and students for their support in the program.

### **Bibliography**

1. Knight, J. Fall 2003. "Updating the Definition of Internationalization." *International Higher Education*. Online. [www.bc.edu/bc\\_org/avp/soe/cihe/newsletter/News33/text001.htm](http://www.bc.edu/bc_org/avp/soe/cihe/newsletter/News33/text001.htm)
2. Ministry of National Education. 2010. 2010 – 2014 Ministry of National Education Strategic Plan (Renstra). Online. [http://www.acdp-indonesia.org/docs/MONE\\_STRATEGIC\\_PLAN\\_2010-2014.pdf](http://www.acdp-indonesia.org/docs/MONE_STRATEGIC_PLAN_2010-2014.pdf)
3. Altbach, Philip G., and Jane Knight. 2007. "The Internationalization of Higher Education: Motivations and Realities." *Journal of Studies in International Education* 11 (3-4): 290-305.
4. Soejatminah, S. 2009. *Internationalisation of Indonesian Higher Education: A Study from the Periphery*. Online. <http://www.ccsenet.org/journal/index.php/ass/article/viewFile/3736/3339>
5. Department for Business, Innovation, and Skills report, 2013. *The Wider Benefits of International Higher Education in the UK*.

## **Microhydro for Rural Electrification as a Learn-By-Doing and Multidisciplinary Project: Lessons Learned**

Andriani Parastiwi and Taufik Taufik  
Polytechnic State of Malang-Indonesia *and*  
California Polytechnic State University

### **Abstract**

As a polytechnic institution, State Polytechnic of Malang Indonesia (Polinema) strives to fulfill its mission to provide learn-by-doing education to its students through multidisciplinary experiences. Many efforts by the administrators and faculty have been implemented to accomplish this. One example in particular has demonstrated a successful faculty-student project engaging students with learn-by-doing activities while enforcing multidisciplinary team work. The project entails the design, construction, and implementation of a microhydro power plant for a rural area in Malang, East Java, Indonesia. The project was conducted in 2012-2013 under the sponsorship from the Indonesian Higher Education agency. The team that participated in the project consisted of faculty and students from different fields of engineering. Lessons learned from the project as well as challenges encountered during the course of the project will be presented in this paper.

### **Introduction**

Polytechnic campuses as the tertiary education institution in Indonesia are designed and well-situated to contribute to the workforce and to stimulate the country's economic growth. Polytechnic institutions are offering professional, career-focused programs in the arts, social and related behavioral sciences, engineering, education, natural sciences and technology that engage students in active, applied learning. Their curriculum is designed with the foundation of blending theory with practice to solve real world problems for the benefit of society. This in turn gives unique opportunities for students to understand how learning connects to careers or to solving real-world problems which are considered important to the cultivation of applied skills needed in the workplace<sup>1</sup>. As a result, employment prospects for graduates from polytechnics are promising. For example, California Polytechnic State University (Cal Poly) reported in 2013 that many graduates reported job offers before their graduation while 82% of the graduates got jobs 3 months after graduation; and 97% got jobs within 9 months after graduation. Another polytechnic campus on the other side of the world State Polytechnic of Malang in Indonesia (Polinema) in the same year also reported many graduates received job offers before graduation while 62% with jobs 1.5 months after graduation. Many of the employers that were surveyed stated that one of the main reasons that they like to hire from polytechnics is the practical skills and knowledge that the graduates possess. This shows the importance of continuing the polytechnic's way of offering the hands on curriculum. However, recently there is one aspect of engineering education that has been deemed important to prepare students to join workforce after their graduation: ability to work in multidisciplinary environment.

The benefits of learn-by-doing education have been widely recognized in academia. Dewey proposed a carefully developed theory of experience and its relation to education who stated that sound educational experience arises from the interaction of two principles: continuity and interaction<sup>2</sup>. On the other hand, Schanks stated that in order to understand anything, we do so by

attempting to find something in our memories that looks sufficiently like it so as to be helpful in processing. The reminding process allows us to learn by causing us to constantly compare new experiences to old ones, enabling us to make generalizations from the conjunction of the two experiences<sup>3</sup>. Either we realize that the new experience is significantly different from the one that we have compared it to, or we realize that it is really very much like it. From the two opinions we can conclude that learn by doing is a human ability to understand more than what was being referred to explicitly in a sentence by explaining the organization of implicit knowledge of the world that one inhabits. Learn by doing philosophy is giving students the opportunity to experience activities while gaining some new knowledge known as learning. Applying learn by doing philosophy to the polytechnic education has been successfully widening students' knowledge beyond curricular material.

In 1995, National Research Council (NRC) and National Science Foundation (NSF) described that the needs of the workforce is changing as the labor market are putting a premium on students who have a broad knowledge of different subjects, and the ability to work in teams. Similarly, ABET as an accreditation institution in the US has placed a criterion in their program outcomes that all undergraduate engineering programs need to provide multidisciplinary learning in their curriculum. This is further emphasized by many studies that show that students with exposure to multidisciplinary experience have the required skills to take on complex jobs following their graduation, and thus, they tend to be more successful later in their career<sup>4</sup>. Universities, including those with polytechnic emphasis, have since tried different approaches to address technological and market demands for interdisciplinary skills. Methods vary considerably in different institutions. However, many were observed to incorporate the multidisciplinary experience in their curriculum through capstone design or senior project courses. One example of an activity that incorporates the learn-by-doing education while requiring the multidisciplinary interaction is the Microhydro power plant project conducted by Polinema with a faculty at Cal Poly as a project collaborator.

### **Microhydro Power Plant Project Development Methodology**

The microhydro power plant (MHPP) project was conducted in 2012-2013 under the sponsorship from the Indonesian Higher Education agency. The team that participated in the project consisted of faculty and students from the electrical engineering, computer engineering, mechanical engineering, and civil engineering programs. Figure 1 depicts the MHPP project development methodology. The figure shows that during the first year (2012) literature study was done simultaneously with the field study. Field study was conducted to observe existing MHPPs in several areas around Malang, as well as, topographic data and hydrometric measurements of irrigation canals. The results of field study in the form of MHPP data or MHPP potential areas were further processed into information that is presented in the information system as potential MHPP map. For each phase of the study a report was written as an outcome. In the second year (2013), the MHPP was designed both at laboratory scale and at a selected site in a rural area of Malang. Additionally, an organizational structure for MHPP was also developed for operation and maintenance. An MHPP operator was selected and then trained on how to manage MHPP so that the existing infrastructure can operate longer and provides economic benefits for the community.

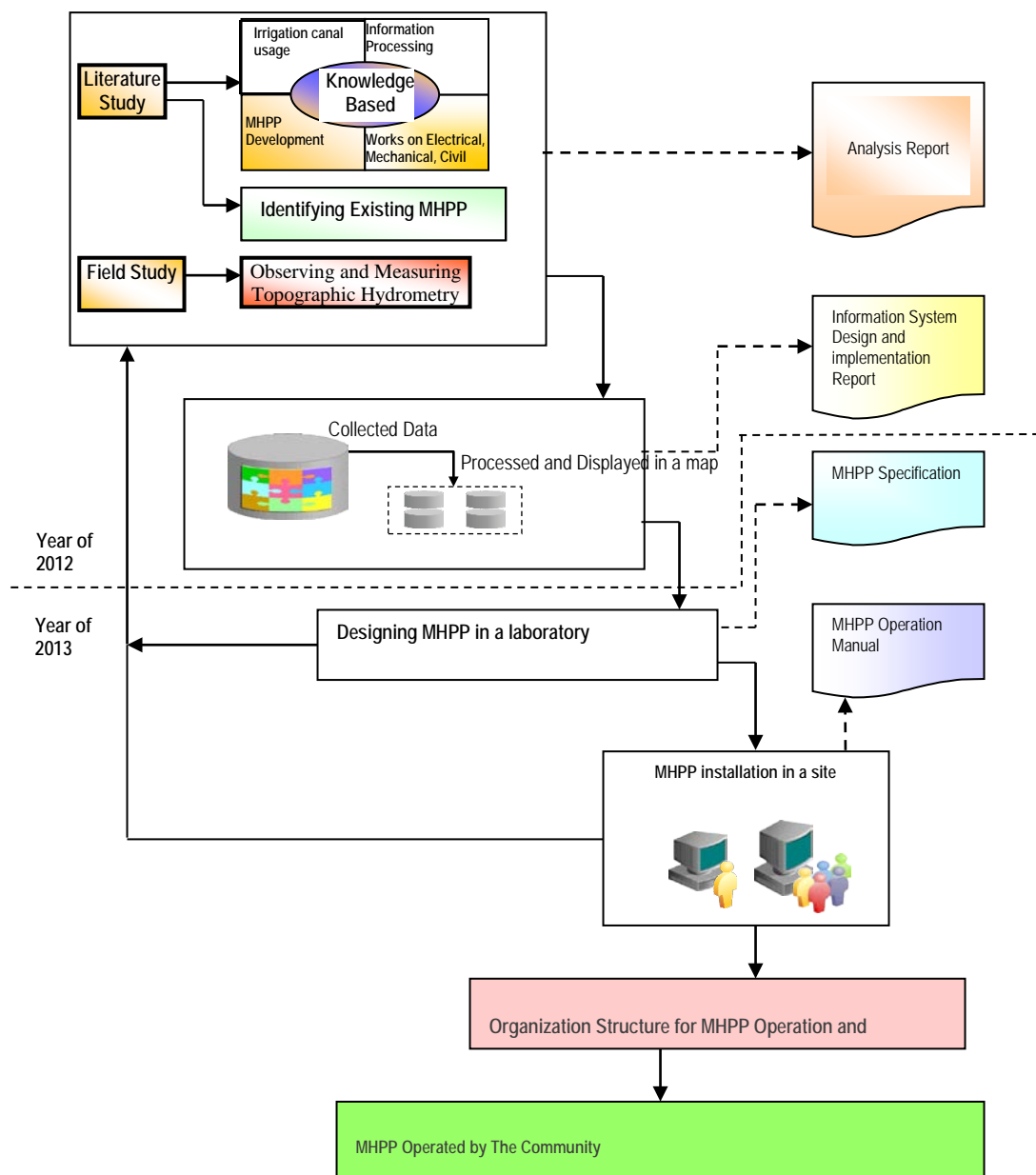

Figure 1. Microhydro power plant project development methodology.

### Microhydro Power Plant

Microhydro power is a small-scale harnessing of energy from streaming water; hence it is a renewable, non-polluting resource that can generate power for homes, schools, and small industries. A micro hydro power plant is a suitable solution for energy needs in rural or remote areas. With proper maintenance, MHPP can be designed to operate for a minimum of 20 years<sup>5</sup>. MHPP may utilize run of the river system. This type of MHPP does not require a dam or storage facility to be constructed<sup>5</sup>. Instead it diverts water from the stream or river, channels it in to a valley and drops it into a turbine via a pipeline called a penstock<sup>6</sup> as shown in Figure 2.

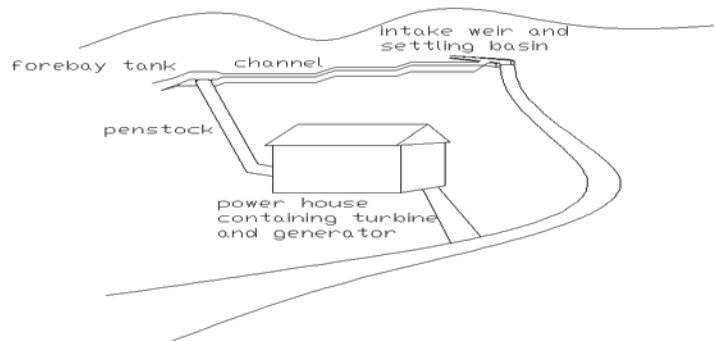

Figure 2. Micro hydro power plant.

The power potential of the water flowing in a stream is determined by the flow rate of the water and the head through which the water can be made to fall<sup>6,7,8</sup>. The cost of MHPP is different for every case, and it is impossible to give an accurate figure without knowing the specifics of the site. However, the cost varies from approximately US\$2,000 to US\$6,000 per installed kW.

### Organizing and Executing the MHPP Project

The MHPP project is a two-year project with the involvement of faculty and students from electrical engineering, computer engineering, mechanical engineering, and civil engineering programs. This project was a multidisciplinary project where coordination of the team was done twice a month. In each phase of the project, students and faculty were working together to complete several particular tasks as seen in Table 1.

Table 1. MHPP project team member and tasks.

Engineering Program	Number of Team	Tasks
Electrical	6	<ul style="list-style-type: none"> <li>- Designing and implementing generator, load controller, and power transmission for the MHPP</li> <li>- Designing the MHPP field survey methods</li> <li>- Conducting field survey for potential MHPP sites</li> </ul>
Computer	3	<ul style="list-style-type: none"> <li>- Designing and implementing irrigation Canal MHPP Information System Map</li> <li>- Conducting field survey for potential MHPP sites</li> </ul>
Mechanical	3	<ul style="list-style-type: none"> <li>- Designing and implementing the turbine, pulleys, and base frame for the MHPP</li> <li>- Conducting field survey for potential MHPP sites</li> </ul>
Civil	3	<ul style="list-style-type: none"> <li>- Designing and implementing the MHPP civil work</li> <li>- Conducting field survey for potential MHPP sites</li> </ul>

As shown in Table 1, all teams were involved in conducting the field survey as it is the most important phase in deciding whether a site is suitable for the MHPP project. Information that was gathered during the field survey is as follows:

- Technical data and information on irrigation canal: location map, topographic map, rain-fall profile, soil structure and stability, and preliminary MHPP design
- Non-technical data and information on community socio-economic infrastructure profile, local capacity and contribution on developing MHPP as an alternative renewable energy.
- Electrification-ratio data and information as well as the energy-consumption growth

prediction, local energy sources profiles, energy availability and energy needs profile, and community involvement in energy provision.

Data were collected using measuring-equipment, observation, and list of survey questions asked to the community as well as to the authority. Students from various major were grouped to perform data collection. Each group had to present their collected data in bi-weekly meeting. In this data collection phase, communication skill is as important as technical ability. As an example, when a person give certain information then the group had to decide whether further inspection is needed to verify the information. The collected data were then analyzed using software developed by the Indonesia Ministry of Energy and the United Nations Development to determine:

- Total distance from transmission line to the farthest user location
- Number of prospective user
- Power capacity
- Water-sources availability all year long
- Accessibility to the location
- MHPP location is not in the national parks/conservation area
- Minimal negative socio, economic, and political impacts

### **Lessons Learned from MHPP Project**

As each team had to present their work at the bi-weekly project meeting, the following learning outcomes were enforced:

- The ability to function on multidisciplinary and cross-functional team
- The ability to communicate effectively though written, oral, and graphical forms
- The ability to manage and to organize given tasks
- The ability to deal with non-technical issues such as management, disaster, etc.
- The ability to decide the best technical design under given constraints

The students were the main field surveyors for the project. They reported that they enjoyed conducting the field work such as measuring water stream along the irrigation canal. Following these surveys, multiple brainstorming sessions were conducted to discuss practices in constructing microhydro power plants, as well as, literature research on MHPP. From these sessions, students demonstrated their ability to bring up ideas to support the feasibility of building a MHPP. One example of a creative idea as a result from these sessions is the method used to measure the speed of water flow. The measurement technique and equipment were developed by the students using readily available and cheap materials: a wooden box, plastic ball, and stop watch. The wooden box is made of a 2m long and 20cm wide plywood as shown in Figure 3. The wooden box is inserted into the flow to obtain stable cross-sectional area in the calculation. A plastic ball was released from one side and the time it takes to reach the other side was measured using a stopwatch. The average time from 10 different runs was then calculated.

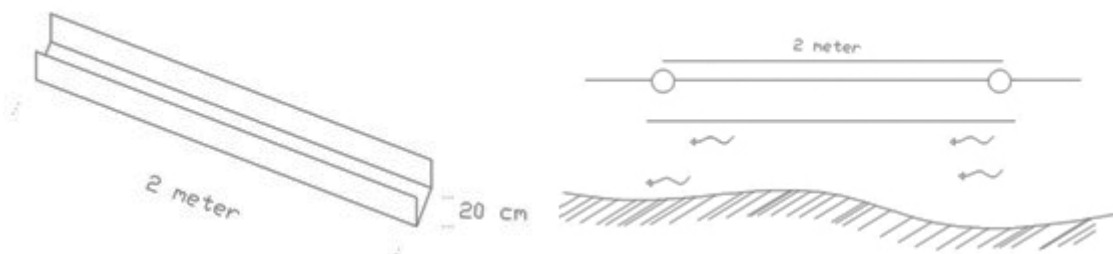

Figure 3. The wooden-box for measuring water speed.

Figure 4 shows how students and community were hand in hand doing field work. During the planning and building MHPP project many challenges and obstacles were encountered such as misunderstanding of several engineering terms and requirements often occurred during brainstorming sessions, as well as in technical reports due to the different terms used within the different fields of engineering. For example, to electrical engineers the unit watts is used for machine's power, while for the mechanical engineers the term horse-power is mostly used. Strict coordination among different teams will have to be managed and executed to prevent miscommunication which may further delay the progress of the project. Communication skills were critical as students were required to explain the operation and maintenance of the MHPP to the community.



Figure 4. Students and Community Working Together Building MHPP.

## Conclusion

With today's emerging technologies that cross over several disciplines, the importance of educating students to function in multidisciplinary environment cannot be understated. Higher education institutions have different ways of achieving this. The microhydro power project conducted by Polinema and described in this paper was aimed to be a learn-by-doing way to enhance students' multidisciplinary skills. Despite the successful completion of the project, difficulties and challenges were encountered with some issues which further emphasized the importance of the multidisciplinary skill. The project has also demonstrated the importance of communication skills especially during field implementation of the project.

### **Acknowledgment**

The *MHPP project* was funded by the 2012 and 2013 IbM-DIKTI renewable energy community service grant. Special thanks to the Directorate General of DIKTI for providing the financial support for the MHPP project, and for the faculty visit SAME program to Cal Poly State University. Thank you also to all of Polinema research teams (faculty and students) for their work in finishing the project.

### **Bibliography**

1. Mercer, P. Ponticell, J. (2012). Polytechnic Education – A Proposed Key to Regional Economic Development. *Synesis: A Journal of Science, Technology, Ethics, and Policy* 2012, T45-T51.
2. Dewey, J. (1938). *Experience and Education*. Toronto: Collier-MacMillan Canada Ltd.
3. Schanks, (1995). *What We Learn When We Learn by Doing*. Online at [http://cogprints.org/637/1/LearnbyDoing\\_Schank.html](http://cogprints.org/637/1/LearnbyDoing_Schank.html).
4. Chen, X., Chase, J., Chase, J. , Wang, W. , Gaynor, P. , et al. (2010). Embedding design projects into multidisciplinary engineering education. *Educational and Information Technology (ICEIT), 2010 International Conference on*, 3, V3-398-V3-402.
5. Wiki. (2012). *How to Plan a Micro Hydro Power Plant*, on line [http://en.howtopedia.org/wiki/How\\_to\\_Plan\\_a\\_Micro\\_Hydro-power\\_Plant](http://en.howtopedia.org/wiki/How_to_Plan_a_Micro_Hydro-power_Plant), accessed at 3June2012
6. Pokharel, S. (2003). "Promotional issues on alternative energy technologies in Nepal", *Energy Policy* 31: 307–318.
7. Arismunandar, A and Kuwahara, A. (1991). *Teknik Tenaga Listrik, Jilid I*, Pradnya Paramita, Jakarta.
8. Brown, J. (1984). *Hydro-Electric Engineering Practice*, CBS Publisher & Distributors, London.



## Student Success in Introductory Physics

Galen Pickett, Prashanth Jaikumar, and Michael Peterson  
California State University Long Beach, Long Beach

### Abstract

The Department of Physics and Astronomy at CSU Long Beach have instituted several reforms in the last decade to support student success across the engineering and physical science fields. First, we have chosen a curriculum in our introductory courses emphasizing a small set of fundamental principles and problem solving. We support the development of these problem solving and critical thinking skills through a classroom response system (I>Clicker), a peer-instruction program in which upper division physics majors model these skills in both the mechanics and the electricity and magnetism laboratories, and through the creation of “engineering-honors” themed sections of these courses. Lastly, we are experimenting with a structured online collaborative system, in which students cooperatively solve physics problems and develop teamwork and leadership skills at an early point in their education. We report on data generated in our introductory physics courses on these dimensions of student success.

### Overview

The Department of Physics and Astronomy at CSU Long Beach has been engaged in a decade-long campaign to reform and tune the first-year physics sequence taken by the vast majority of engineering students, calculus-based mechanics (PHYS 151) and electricity and magnetism (PHYS 152). Our point of view has been that these courses should serve as a first, positive experience in STEM coursework, rather than as barriers to students seeking engineering degrees and careers. To this end, the course revision was done to actively engage students in the discipline of physics as practiced by physicists. While the content of our courses has not changed, we approach the subject from a modern point of view, in which the speed of light is an important barrier, and in which matter is made from atoms. Coupled with developing softer yet vital career skills in collaboration and teamwork, this approach has dramatically increased not only the passing rate of these courses, but has also dramatically (and positively) affected students’ perceptions of themselves and what they are doing in a STEM major. We describe below the reform curriculum we have adopted, an important peer-learning strategy employed in the department, our peer-to-peer support system, and then the impact of our honors sections before displaying assessment data from these courses.

### Matter and Interactions

The *Matter and Interactions* curriculum has been in development in the Physics Education Research Group of North Carolina State University since 2003.<sup>1</sup> A rich thread of approaching problems through computer programming in VPython undergirds the course, freeing the instructor from dealing with the highly restricted set of analytically solvable problems which are approachable with first-year physics methods. Thus, the approach is closely related to finite element methods students will use intensively further along in their engineering studies. Thus, in adopting a computational tool, we are able to concentrate on the logical structure of the solutions to problems, rather than tempting student to remember long lists of analytic results (along with

their ranges of applicability). The course thus reduces to three fundamental concepts (having to do with momentum, energy, and angular momentum) and how those concepts fit together to describe realistic interactions between cars, galaxies, or even elementary particles.

This approach focuses on how practicing physicists actually use these fundamental ideas in their own academic work. We have found that maintaining high student involvement and enthusiasm in the course is related to both how students see these ideas being used in their further studies, but also in seeing an expert in the field use these ideas in their own right. The “flavor” of doing physics the way physicists do is strongly enticing for students, who otherwise experience this subject as too “theoretical” and removed from their own ambitions and lives. Indeed, the number of physics-engineering double majors has increased steadily since we have adopted this curriculum. Given that there are a high proportion of students from underrepresented groups attempting engineering degrees at CSULB, our reformed curriculum is enhancing opportunities available for this vital group of students.

### **I>Clicker**

The vast majority of students at CSULB take these introductory courses in a large lecture format, with class sizes ranging from 60-180. Maintaining consistent attendance and engagement of students in these large environments and providing instructors feedback about how students are understanding lecture components is a perennial issue in large-format general education courses. We have to a large degree met both goals through integrating a classroom response system, in this case with the CSULB campus standard I>Clicker.<sup>2</sup> Here, lectures are broken up by simple, but probing, multiple choice questions that each student answers with a semi-anonymous press of a button. There is ample time for students to discuss their answers while a standard timer is counting down, and there is a large proportion of participation credit associated with the device. Thus, the device is not used to perform high-stakes assessments (in the form of real-time multiple-choice exams) but rather gives students a chance to digest and use the information that has just been introduced. In this manner, an instructor can decide on the fly if a concept needs reinforcement, or if the topic has been sufficiently well understood by the class as a whole. Thus, the clickers are used to guide instruction on a day-to-day, and minute-to-minute basis in the classroom.

### **Learning Assistants**

Starting in 2010, the department has instituted a “Learning Assistant” program based upon the model established by the University of Colorado.<sup>3</sup> In our program, promising students in either PHYS 151 or PHYS 152 are encouraged to take an upper-division training course in physics pedagogy, PHYS 390 “Exploring Physics Teaching”. This course counts toward physics upper-division elective credit in all physics degree programs. In this course, students are trained in asking probing questions and in effective interactions as an instructor. They spend six weeks assisting students in the PHYS 151 laboratory, and ten weeks in the college’s student supporting center offering free walk-in tutoring for PHYS 151. Upon completing the course with at least a “B” grade, they are eligible to be hired as a “Learning Assistant” in the department. These are not “teaching assistants” in that they have absolutely no grading or evaluation duties, and they are not responsible for creating lecture content as a Supplemental Instructor is required to do. Their basic role is to ask and answer questions, and even more importantly to know which questions must be answered with other questions in order to advance learning. We have placed

Learning Assistants in PHYS 151 and PHYS 152, and they are being deployed in the upper-division courses that physics-engineering double majors take most often, and have the most difficulty with (PHYS 310 “Analytic Mechanics”, PHYS 350 “Modern Physics” and PHYS 340A “Electricity and Magnetism”). Students in these courses see their Learning Assistants as peers in whom they can more easily confide confusion, and more quickly take risks with answers that are incomplete or based on misconceptions. Interacting with Learning Assistants has a profound impact on how we achieve all of our course goals.

### **Social Homework and Group Problem-Solving**

The STEM professions are characterized by highly collaborative workflows. Working effectively with highly-trained and high-functioning peers from vastly different social, ethnic, and national backgrounds is a requirement for succeeding in today’s STEM workforce. We are implementing on a trial basis an asynchronous web-technology that gives students at the very start of their technical education the experience of working collaboratively in a “research group”. This so-called “Social Homework” system allows an instructor to assign students into working groups with specific problems to solve, and with specified roles for each group member to perform.<sup>4</sup> It is based on the ground-breaking work on cooperative group problem-solving in the University of Minnesota’s Physics education research.<sup>5</sup> The groups generally are stable for an entire semester, and students get a part of their grade from their individual work, but also from the group effort as a whole. The individual roles are modeled on the problem-solving strategy used in our reform Matter and Interactions curriculum and also mimic those roles that are performed in a real STEM research group. Each problem is couched in the same language as a “Request for Proposals” and the deliverable at the end of the process is a properly formatted solution which is shared with the entire class. These “deliverables” constitute a student generated “wiki” that everyone can consult to help in completing their individual homework problems. Being accountable to a group, depending on a group, and most importantly evaluating the quality of a group’s performance (quality control) are the new elements this system adds to the PHYS 151 and 152 sequences. We have strong evidence that social homework increases the integrity of the educational process, and those students who are in the C-D grade range benefit substantially.

### **Honors Sections**

Completion of degrees in a timely manner is rightly an important priority for any public institution of higher learning. Thus a lot of faculty attention and administrative support goes toward helping students who are struggling complete these, admittedly, quite hard STEM degrees. Seeing that students who are excelling get the most from their degrees is likewise an important priority, and we have created engineering-honors sections of PHYS 151 and 152. These sections use both the Matter and Interactions curriculum, and social homework is being implemented on a trial basis in these courses. These are small sections composed entirely of engineering honors students and students who intend to become physics majors. Thus, we have a high-performing group of extremely well motivated students. These sections are small (less than a sixth of the size of an ordinary large lecture in the department) and are taught in technology-enhanced “Active Learning” classrooms on campus. Here, students sit at tables of eight, with a plasma display showing material from the instructor. The wall of the room can be written upon from floor to ceiling with ordinary whiteboard markers. An important part of the honors course is a face-to-face experience in solving challenging problems in a collaborative

environment. While it is too early to discuss the outcome of the honors sections, we are confident that the results will be positive and similar qualitatively to the inclusion of “Social Homework” in the regular sections due to the close interactions between students with one another and with the teacher.

## Results

The biggest institutional evidence of success in our efforts is that the introductory physics sequence is no longer a gateway course with a low completion rate. In the last four semesters, the D, W, F rate in this course has fluctuated narrowly in the 10% range, without sacrificing the rigor of the material. In a sense, introducing computational methods and modern concepts and methods has made the course more difficult, but student performance is measured in a highly diverse set of measures (content in exams, group skills in the social homework, laboratory work, and homework, for example). Thus, even with the more challenging curriculum, students have a fair shot at learning the material, and passing these classes.

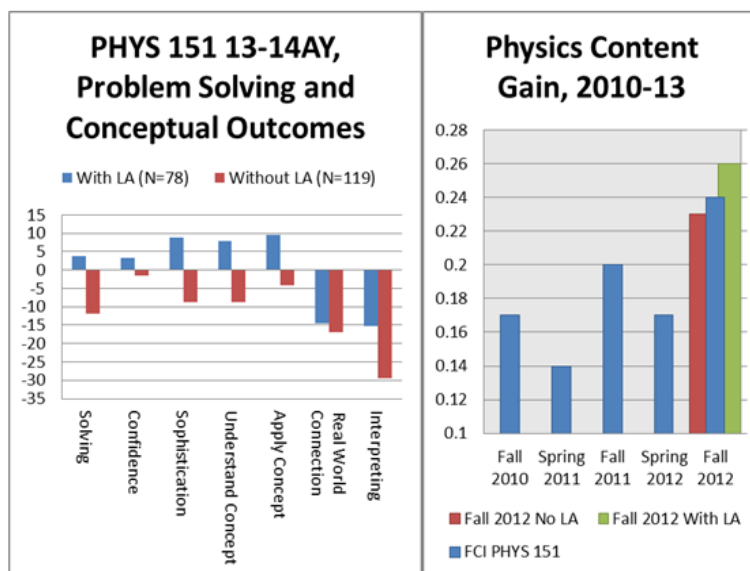

Figure 1. Learning Assistant Impact in PHYS 151.

In figure 1 we present our main evidence for student success in PHYS 151. There are two graphs, each showing the results of a pre/post “value added” measurement of student performance and attitudes in PHYS 151. On the left we present the measurement of several dimensions of STEM “practice” from an instrument developed at Colorado: the Colorado Learning Attitudes About Science Survey (CLASS).<sup>6</sup> This is a 42 item instrument scored on a Likert scale and normalized to the responses physics faculty make to the same items. These items are not physics problems per se, but are meta statements about how problems are approached and interpreted, and thus provides a direct measure of critical thinking skills across its many dimensions. While we have work to do to support students connecting their physics studies to the real world and in interpreting their solutions, when we add Learning Assistants to the laboratory sections, problem solving across its many dimensions is remarkably enhanced. Additionally, the Force Concept Inventory<sup>7</sup> indicates that in the first semester in which we had large LA coverage, our measure of mechanics content mastery is large when LA’s are present (green bar) and is improved even in lab sections without LA’s (as a result of their drop-in

tutoring and social interaction through the Social Homework tool). While data from Spring and Fall 2013 are not yet fully analyzed, there are indications that these gains are enhanced in the honors sections we have introduced.

Indeed, we can make the claim that all of the elements we have introduced (M&I style homework, laboratory work, Social Homework, I>Clickers, and problem solving exams), the Social Homework (SHW below) is the “glue” that makes the course intellectually consistent. Before experimenting with SHW, the  $r^2$  correlation value between the M&I homework and, for example, the course exams, was rather weak, on the order of 0.1, meaning that completing the homework successfully explains 10% of the exam grade performance for an individual student. As in Table 1, the correlations between various course elements is now well above statistical significance level, with extremely strong correlations, and the strongest correlations between the SHW score and all of the others.

Table 1. Correlations between different course grades, PHYS 151, Spring 2013.

	<i>M&amp;I</i>	<i>Lab</i>	<i>SHW</i>	<i>Clicker</i>	<i>Exam1</i>	<i>Exam2</i>
M&I	1					
Lab	0.504341	1				
<b>SHW</b>	<b>0.668322</b>	<b>0.483636</b>	<b>1</b>			
Clicker	0.502102	0.480227	<b>0.560495</b>	1		
Exam I	0.304513	0.387333	<b>0.290939</b>	0.252759	1	
Exam2	0.615823	0.531764	<b>0.572702</b>	0.392227	0.444384	1

Thus, we are confident that we have constructed a sound curriculum that prepares rather than filters prospective engineering students for their further studies.

### Bibliography

1. R. Chabay and B. Sherwood, "Modern Mechanics," American Journal of Physics 72. (2004). p. 439-445.
2. [www1.iclicker.com](http://www1.iclicker.com)
3. Otero V, Pollock S, Finkelstein N. 2010. A physics department's role in preparing physics teachers: The Colorado learning assistant model," American Journal of Physics. 78(11):1218
4. [www.socialhkw.com](http://www.socialhkw.com)
5. <http://groups.physics.umn.edu/physed/Research/CGPS/CGPSintro.htm>
6. [www.colorado.edu/sei/class](http://www.colorado.edu/sei/class)
7. David Hestenes, Malcolm Wells, and Gregg Swackhamer, "Force Concept Inventory" The Physics Teacher, Vol. 30, March 1992, 141-158

## Linking Theory with Experiential Learning in Virtual Learning Environment

Reza Raeisi, Max Gardner, and Ricardo Rangel  
California State University, Fresno

### Abstract

This NSF-founded project presents work on new ways of delivering technical instructions to engineering students through distance using customized Virtual Learning Environment (VLES) tools. An important aspect of this paper is to present the efforts by a group of faculty from five different institutions, hailing from three different regions in the country. The goal of the project is to develop a curriculum for the dissemination of an Embedded System Course through active participation of students in the virtual environment.

The VLES has been designed to deliver technical instruction and course materials in embedded system design course through audio-video based distance learning. The supporting distance learning curriculum and laboratory modules, using modular instructional materials along with VLES training, will be presented. The curriculum has been tested through summer workshops which demonstrated that VLES can be used for real-time teaching and learning hands-on technical subjects. A curriculum focusing on embedded system programming and utilizing the developed training system, with lessons focused on Assembly Programming with peripherals interfacing modules, will also be presented. It is anticipated that the VLES, which is an open source framework, can contribute towards adoption in more institutions as the developed course modules are scalable. The active participation of participants for empirical lessons through audio-video technologies has been tested as a pilot program and its impact has been positive. In the future, our intent is to propose the VLES concepts as a new addition to current secondary education in the central valley to promote engineering and technology. Addition of the concept to the current curricula in secondary education will inspire students to pursue Science, Technology, Engineering, and Mathematics (STEM) disciplines at earlier age.

The project experience and data collected from the faculty who participated in the summer workshops will be presented including focus on the following topics:

- Design and development of the VLES and supporting instructional materials
- Link theory and experiential learning with active online participation
- Assessment of the learning experience
- Experience on collaboration on teaching at other academic institutions

### Introduction

The goal of this NSF-funded project is to disseminate an effective Embedded System Course through Virtual Learning Environment tools (VLES). This project is based on a three-year timeline. During the first year of the project, a microcontroller training system was developed that paralleled the curriculum. This training board has various modular components, from basic items such as LEDs, DIP switches, and a breadboard, to more advanced components such as keypad, LCD display kit, and LED numeric display. Thereafter, a curriculum focusing on microcontroller programming and utilization of the training system was developed.

During the second year, the VLES, curriculum, and training board were used to train faculty members from high school, two-, and four-year universities from across the nation. They learned important embedded system principles along with how to operate the training system. The goal of the training was to enable faculty members to teach the curriculum at their schools. The training also included learning VLES principles to be able to teach the curriculum at their schools online. Since the VLES incorporates a free open source framework based on Moodle, it offers a simple tool for distance learning. Moodle is a learning platform designed to provide educators, administrators, and learners with a single robust, secure and integrated system to create personalized learning environments [1].

### **Design and Development of the VLES and Supporting Instructional materials**

For effective delivery and feasibility of linking theory with experiential learning in virtual learning environment, a server based on Moodle for teaching and learning has been designed and implemented. A Moodle server platform was used to access all the course curricula information for learning and completing embedded system experiments. The Electrical and Computer Engineering Department at California State University, Fresno (CSU, Fresno) hosted the web server for the Moodle system which was used by all five different institutions. The Moodle server was customized, built, and tested at CSU, Fresno in the following five phases:

1. Ordering of the hardware/software components
2. Integration of the components to develop a Ubuntu based server
3. Implementation of the web server for using the Moodle system:
  - a. Specifying and setting up the required components for running PHP
  - b. Creating the required components for running MySQL
4. Implementation of the system:
  - a. Uploading Moodle software to the web server
  - b. Running the installer script (install.php) on the web server
  - c. Implementing the entire necessary configuration
  - d. Connecting Moodle system to MySQL database to store the data
  - e. Setup administration and user access
5. Testing the system in four level:
  - a. Administrative
  - b. Teacher
  - c. Student
  - d. Guest

Installing Moodle on a web server is a challenging task, with constant user interaction to continue on the install prompt. The requirements for installing are that the computer in question has a Linux distribution, a web server such as Apache or IIS, PHP which is a web scripting language, and a database, using either MySQL or PostgreSQL. For the installation on the CSU Fresno server, we used Ubuntu 12.04, Apache, PHP, and MySQL. For the steps required, a search of the internet on installing Moodle will forward you to the Moodle installation page, where during installation, make sure to use the correct version of all the software in the documentation provided on the internet. Moodle supports multimedia dissemination with lesson videos, webcam and microphone enabled classes, as well as web-based assignment submission.

It also contains a discussion forum for students and faculty to collaborate and discuss assignments, problems, and projects.

The Moodle system provides the entire embedded system curriculum as well as necessary resources such as the PIC microcontroller datasheet and the training sheet for the PIC board. Each lesson plan was stored in individual modules that contain all of the instructional resources to learn and complete the lesson plan. The student has the option to complete the course in C, BASIC, or Assembly language. The first few lesson plans teach the fundamental steps for using the trainer board along with instructions about using the programming software MPLAB. This software is an integrated development environment which provides all the tools necessary to assemble codes for embedded microcontrollers. It has many features that support concepts through visualization and experimentation. The simulation tools allows students to follow their code line-by-line for effective debugging. Once the code is completed, the student can easily upload the code into the trainer system for implementation. The next portion of the curriculum consists of individual controls such as I/O interfacing using switches and LEDs. The curriculum then shifts to integrated microcontroller enabled systems design and programming. The LCD display kit and keypad controls are used to design systems that accept foreign input and direct output to modular devices. As the course progresses along the curriculum, the students design advanced systems for data logging, RF (radio frequency) sensing, motor controls, Analog-to-Digital conversion, and SPI (Serial Bus) protocols, etc.

Each lesson plan contains a Learning Module and a Lab Module. These technical manuals educate the students about the microcontroller architecture and how to incorporate it with PIC training system. The learning module describes all the conceptual knowledge required to implement the embedded microcontroller feature. It describes the applications of the feature and thoroughly shows how to configure the registers for proper execution. Flowcharts were used to guide students through the logical operation of each learning modules. The lab module contains all the information needed to make the physical connections. It includes schematics, diagrams, and photos. It also shows how to upload the program into the trainer board. Moodle and the instructional material provided the foundation for the course. The final tool to complete the distance learning experience was Adobe Connect. Adobe Connect is a web conferencing platform based at ODU for web meeting and eLearning purpose. The virtual learning environment of Adobe Connect allows interactive one-on-one communication with the instructor that provides an experience simulating on-campus learning. Each student was provided with a webcam and microphone to allow for a live video conversation. By having access to a live video, the instructor is able to see the completed project demonstration, help with troubleshooting, or provide any other special assistance. Adobe Connect also has a screen share feature so the instructor can view and control the student's computer screen remotely. This access increases collaboration with debugging. The platform has the option to have a private conversation with the instructor or discuss embedded system concepts publicly with the class. Adobe Connect completes the virtual learning environment tools that resembles laboratory courses.

### **Supplementary Modules**

The following three modules were developed at CSU Fresno and added to the curriculum:

1. Internal Pulse Width Module for Motor/Servo Implementation: A usage of the Pulse Width Module (PWM) was used to control the output of two DC Motors. This feature controls the speed of the motors with very minimal supervision. This enables the microcontroller to



perform other tasks while still managing the motors' speed. The setup is shown below in figure 1.



Figure 1. Two DC motor control.

2. Feedback Loop with IR Sensing and DC Motors: This experiment combines a distance measuring sensor and a motorized RC vehicle to create an embedded control system. The distance measuring sensor is the feedback signal, and the output is a DC motor which controls the position of the vehicle. The controller maintains the vehicle within 20cm – 30cm from a reflective surface. The setup is shown in figure 2.



Figure 2. Feedback loop embedded system.

3. Multi-Processor Communication using a SPI protocol: The goal of this experiment was to establish communication between processors using Serial Peripheral Interface (SPI). One processor was configured as a Master, and two were configured as Slaves. The Master was programmed to send a message to the Slaves consecutively. The Slaves were programmed to “listen” for the message and displayed it on an LCD. The hardware setup is shown in Fig. 3.

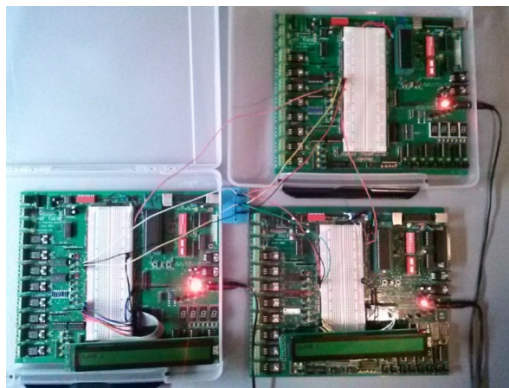

Figure 3. Multi-processor communication using SPI.

### Curriculum Adoption at CSU, Fresno

The training board and curriculum has been adopted at CSU, Fresno ECE department to teach ECE 118 (Microprocessor Architecture and Programming) and its laboratory complement ECE 120L (Microcontroller Laboratory). Overall, the students are pleased with the curriculum along with using the PIC training system and accessing Moodle. In the future semester, student's learning outcomes in embedded microcontroller systems will be assessed.

### Assessment of the Learning Experiences

The following is a statistical report for the summer 2013 workshop. There were total of ten modules; however, seven Modules (1-7) were used. However, the actual tests involved Modules 1-10. The Pre-Test and Post-Test scores are reported for Modules 1-7.

Participants = 56

**Pre-Test:** Mean = 5.26, Median = 4, SD = 4.97, and Range was 0-19

**Post-Test:** M = 15.45, Med. = 17, SD = 5.06, and Range was 6-22

### Opinion Survey Results

Module Goals – I was able to (SA= 5 to SD = 1):	Statistics
1. Describe the fundamentals of microcontroller technology.	Mean=4.52 Median =5 SD = 0.57
2.1.a. Perform math and logic operations in different numbering systems.	Mean=4.23 Median =4 SD = 0.77
2.1.b. Explain basic logic gate operations.	Mean=4.49 Median =5 SD = 0.63
2.1.c. Program a PIC microcontroller in various numbering systems using mathematics and logic operations.	Mean = 4.11 Median = 4 SD = 0.82
2.2. Use STATUS flags to operate programmable intelligent computer (PIC) controlled devices.	Mean = 4.09 Median = 4 SD = 0.86
3.a. Explain the PIC16FXX embedded system circuit design.	Mean = 4.13 Median = 4 SD = 0.76
3.b. Use I/O pin configuration and control functions with an internal CONFIG register.	Mean = 4.27

	Median = 4 SD = 0.65
4.a. Explain the use of a flowchart for PIC programming.	Mean = 3.93 Median = 4 SD = 1.01
4.b. Calculate and write a time delay loop(s).	Mean = 4.07 Median = 4 SD = 0.83
4.c. Identify the ranges and uses of the DM and PM.	Mean = 3.59 Median = 4 SD = 1.02
5. Describe the structure, purpose, and potential applications of the WDT timer.	Mean = 4.27 Median = 4 SD = 0.67
6. Explain the structure and the application of interrupts, flags, global enablers, and individual enabler setups, interrupt handler hardware and software, IRQ configuration, polling vs. ISR (IRQ service routines), and prioritize IRQ services in the program control.	Mean = 4.11 Median = 4 SD = 0.73
7. Use parallel data communication between the microcontroller and other devices such as a LCD module.	Mean = 4.14 Median = 4 SD = 0.80
8. Use a matrix keypad interface.	Mean = 3.91 Median = 4 SD = 0.94
9. Use hardware/software for programming, interfacing, and testing with uni-polar and bi-polar stepper motors.	Mean = 3.38 Median = 4 SD = 1.07
10. Use hardware/software for programming, interfacing, and testing with DC motors.	Mean = 3.27 Median = 3 SD = 1.09

### Training Opinions

Answers were coded 2 (Mostly Positive) and 1 (Mostly Negative)

11. What is your overall impression of the course modules for assisting you with understanding embedded technology knowledge and applications?	Mean = 2 Median = 2 SD = 0.00
12. What is your overall impression of the technical capabilities of the embedded learning hardware platform?	Mean = 1.95 Median = 2 SD = 0.23
13. What is your overall impression of learning using the embedded technologies system (training platform and modules)? Did it satisfy your learning needs?	Mean = 1.96 Median = 2 SD = 0.19
14. Were you able to learn to use this system through distance learning technologies?	Mean = 1.91 Median = 2 SD = 0.29
15. Do you plan to use distance learning technologies for instruction in the near future? Yes (2) and No (1)	Mean = 1.69 Median = 2 SD = 0.47

Points of interest:

- Very good feedback from the participants.
- Major growth from pre-test through post-test scores.
- There were 22 possible correct answers from the test questions on Modules 1-7.

- Post-test mean was 17
- Good for the mixed experiences of our 56 participants.

The follow-up survey shows where we stopped teaching content at the end of Module 7 because of workshop time shortage; this is indicated by lower mean scores on the questions. The overall assessments of regional joint efforts are shown in Items 11-15, where “2” indicates the high score and “1” indicates the low score. The median response is “2” for all of these items. A most interesting revelation showed that 69% of participants reported considering using distance learning in future technical instruction. The average score on correct responses to the knowledge pre-test was 5.19. The range was 0-19. There were many participants who expressed lack of familiarity with embedded technologies before the workshop. The post-test results was 6-22, with the average score of 15.45; a significant knowledge increase.

### **Follow-Up Survey Open-Ended Questions**

This curriculum was used in teaching faculty from various universities in summer 2013. The faculty members were provided with the tools necessary for the cyber-enabled course, i.e. the PIC microcontroller from Microchip and the PIC training board developed. 21 participants expressed interest in teaching technical concepts via distance learning; this attests to their overall satisfaction with our distance delivery capabilities. 30 participants indicated that they could learn to use our distance learning system, while 32 reported satisfaction with the trainer and the supporting curriculum. The developed training system and curriculum has been adopted by the Electrical and Computer Engineering department at CSU, Fresno to teach ECE 118 (Microprocessor Architecture and Programming) and its lab component ECE 120L (Microcontroller Laboratory). Overall, the students responded positively to the PIC training system, accessing Moodle, the curriculum, and Adobe Connect. There are future plans to assess students’ learning outcomes with regards to use of embedded microcontroller systems.

### **Conclusion**

This project promoted the use of efficient curricula for hands-on engineering courses and via the development of an effective teaching methodology for microcontroller technology. The result of the summer workshop demonstrated that VLES can be used for teaching and learning hands-on technical courses via real-time VLES. The affordability of the training system and simple access to the curriculum will promote interest in the STEM fields at an earlier age. It is believed that this tool will stimulate a stronger workforce in the area of embedded systems.

### **Bibliography**

1. MicrochipTechnology Inc. <http://www.microchip.com>
2. Moodle, <https://moodle.org/>
3. Adobe Connect, <http://www.adobe.com/products/adobeconnect.html>
4. Ubuntu Operating System, <http://www.ubuntu.com/>

## **Preparing Community College Students for Civil Engineering Profession through Design and Evaluation of a Three-Story Steel Plate Shear Wall**

Agustin Robles, David Alvarez, Jasmine Flores, Cham Htun, Cheng Chen, James Enright, Amelito Enrique, Wenshen Pong, Hamid Shahnasser, Hao Jiang, and Hamid Mahmoodi  
Cañada College/ San Francisco State University

### **Abstract**

Future earthquake disaster prevention and preparation require that young professional civil engineers are trained and recruited into the next generation workforce for the purpose of public safety. Community colleges serve as the gateway to higher education for large numbers of students in the U.S., especially Hispanic and low-income students. Preparing community college students for their future civil engineering profession is of great significance to our society. In summer 2013, four sophomore civil engineering community college students participated in a ten-week summer research internship program at the School of Engineering of San Francisco State University. Supported by the NASA CIPAIR (Curriculum Improvements and Partnership Award for the Integration of Research) program, the four students were advised to use commonly used structural engineering design specifications and seismic provisions to design a three-story steel plate shear wall. Design tools and software applications such as Excel, MathCAD and SAP2000 were used by the students to achieve an economical and efficient structural design. This research internship program allows for the development of project management, time management and teamwork skills, thus helping strengthen students' knowledge of seismic design in civil engineering and prepare them for successful academic and professional careers. The internship program therefore provides valuable mentorship for community college students during their transition to a four-year college and their decision to pursue a civil engineering profession.

### **Introduction**

Recent earthquakes in California and Japan have caused significant impact on human society (20 killed, \$20B in direct losses during the 1994 Northridge earthquake, and 5500 killed, \$147B in direct losses during the 1995 Kobe earthquake). Similar earthquakes of magnitude 6.0 or greater can have more profound impact on the greater San Francisco Bay Area. Future earthquake disaster prevention and preparation require that young professional civil engineers be trained and recruited into the next generation workforce as part of the efforts to mitigate the seismic hazard and improve public safety. Over the past three decades, interest in the application of Steel Plate Shear Walls (SPSWs) as the lateral force resisting system in high-risk seismic areas has greatly increased around the world. In North America and Japan, SPSWs have been implemented in a 35-story office building in Kobe and in the Sylmar Hospital near Northridge. In the early 1980s in Canada, Kulac became the first to analytically and experimentally research SPSWs in an attempt to standardize building design<sup>1</sup>. SPSWs provide many significant advantages to seismic-resistant buildings; they have high plastic energy dissipation, enhanced stiffness, strength, and ductility, and offer substantial economic advantages. In this paper, we will present a collaborative training program between San Francisco State University (SFSU) and Cañada College funded by the National Aeronautics and Space Administration (NASA). This program

aims to strengthen community college students' foundation in the academic fields of science, technology, engineering and mathematics. Four community college students participated in this program in 2013 and were trained to perform seismic design and evaluation of a three story steel plate shear wall.

### Student Project Description

The team of four students was asked to design a three-story SPSW structure located at 1300 Market Street, San Francisco, CA 94103. A SPSW frame is comprised of a rectangular system of rigidly jointed columns and beams with a thin steel infill plate which resists the lateral forces developed during earthquake ground motions. The flexural rigidity of the frame and the shear strength of the plate is the source of lateral stiffness and strength for the entire frame system. This structure is going to be an office building designed with large open spaces in the center, and large windows to allow for natural light to enter. The seismic weight of each floor of the building is assigned as 95 psf on the roof, 90 psf on the third floor, and 92 psf on the second floor. The height of the building is 36 ft, with 12 ft story heights at each floor. As seen in Figure 1, the base of the structure is shaped like a cross with a width of 150 ft and a length of 120 ft. The frames steel plates, horizontal boundary elements (HBEs), and vertical boundary elements (VBEs) are to be designed according to AISC's code provisions<sup>2</sup> and ASCE 7-10 equivalent lateral force procedures<sup>3</sup>. Evaluation of the final structure will be completed using SAP2000 and a Time History Analysis of its response to three selected earthquake ground motion will be modeled.

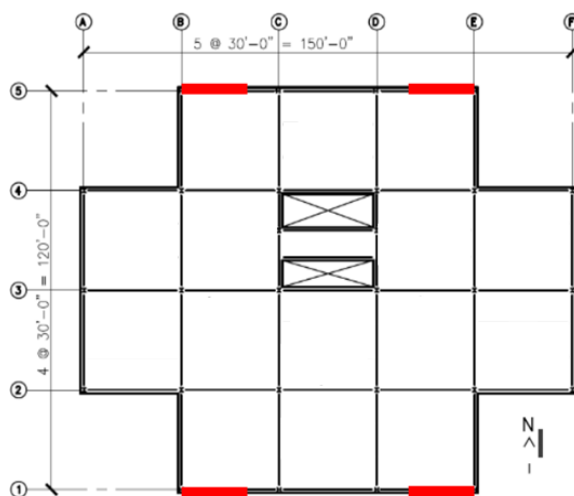

Figure 1. Building plan.

### Design Procedure and Product

The design of the structure was split into two parts: (a) Apply the ASCE 7-10<sup>2</sup> equivalent lateral force procedure to determine the base shear, the period of the structure, and the vertical distribution of forces on the frame; (b) Select the optimal sizes for the steel plates, HBE and VBE required on each floor by following the AISC codes using MS Excel or MathCAD. The ASCE 7-10<sup>3</sup> equivalent lateral force procedure was used to determine the minimum lateral forces used for design of the three-story office building. The equivalent lateral force method involves the application of a set of representative or equivalent static lateral forces on each level of the

structure that produce horizontal deflections. These induced deflections approximate those caused during ground motions.

To find the vertical load distribution of seismic forces on the structure, the base shear,  $V$ , of the structure is distributed to each floor according to the floor's vertical distribution factor,  $C_{VX}$ , which is dependent on the height and weight of each story of the structure. The lateral force applied at each level is then calculated by using the equation,  $F_x = C_{VX} * V$ . In order to find the horizontal load distribution of seismic forces on the structure,  $V_x$ , the sum of the lateral forces of each of the floors above it were calculated. These calculations are shown below in Table 1.

Table 1. Vertical distribution of lateral forces.

Vertical Distribution of Lateral Forces:						
Level	$w_i$	$h_i$	$w_i * h_i^k$	$C_{VX}$ $= \frac{w_i * h_i^k}{\sum(w_i * h_i^k)}$	Lateral Force $F_x$ $= C_{VX} * V$	Story Shear $V_x$ $= \sum F_x$
units	kips	Ft			kips	kips
roof	1305.3	36	46990.8	0.512	278.2	278.2
3rd	1236.6	24	29678.4	0.323	175.7	453.9
2nd	1264.1	12	15169.0	0.165	89.8	543.7
Total	3806.0	-	91838.2	1	543.7	543.7

For the analysis of the structure, one frame was modeled in SAP2000<sup>4</sup> using the strip-model, shown in Figure 2, to represent SPSWs. The strip-model consists of at least ten strips in each direction inclined at an angle ( $\alpha$ ) relative to the vertical. Cables are utilized in place of the strips as they work only in tension and serve as an accurate representation of a SPSW frame's response to lateral forces. To calculate the cross-sectional area of the cables, the tributary width between strips is multiplied by the assigned thickness of the plate on each floor. To acquire the appropriate properties of the boundary elements of the frame, the sizes of the wide flange members were selected and input into the applicable positions on the designed frame.

Three historic earthquake ground motions were selected from the Pacific Earthquake Engineering Research Center (PEER) Ground Motion Database based on their location, intensity, and the duration<sup>5</sup>. The selected ground movements were imported into SAP2000 where a time-history analysis of the frame will be performed in order to review the buildings response. These ground motions will act as a seismic load on the structure in the east-west direction and will provide an accurate representation of how well the structure performs under high seismic activity. As seen in Figure 3, the ASCE 7-10 approximate fundamental period of the structure, .29 seconds, is 41% shorter than that of the model. This discrepancy in the ASCE 7-10 calculation of the fundamental period presents a highly conservative estimate of the period which assures that the maximum spectral acceleration forces act on the structure. Although for the design of this three-story structure the difference between the calculated and the actual period did not make a difference in the spectral acceleration forces acting on the structure, in the analysis of a taller structure, this difference would lead to an over-estimate of these forces.

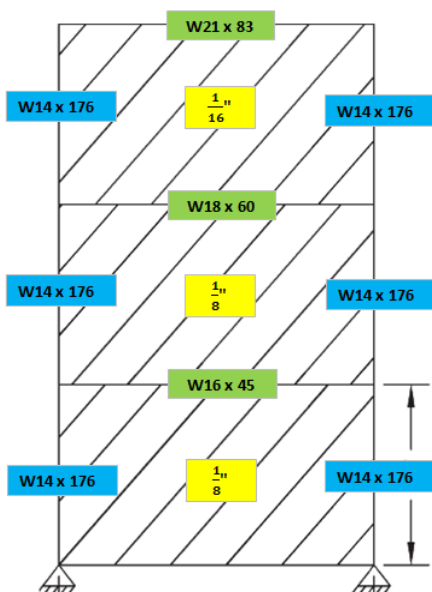

Figure 2(a). Preliminary design

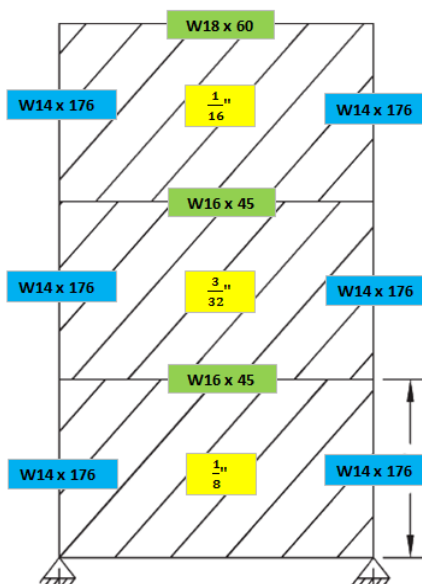

Fig. 2(b). Final design

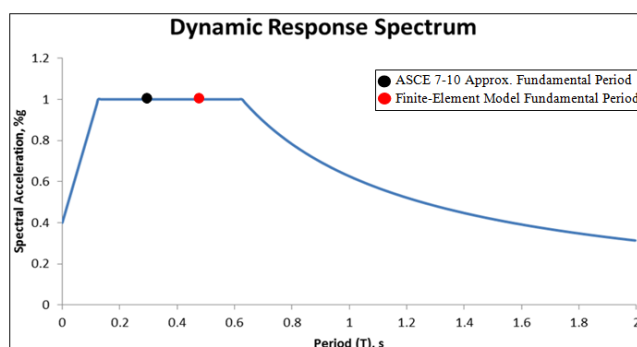

Figure 3. Dynamic response spectrum.

The drift of the entire building is calculated by measuring the horizontal displacement of one corner of the roof from its rest position to its maximum deflection position. For simplicity, the drift of the structure is going to be calculated in the inelastic range. Although SAP2000 outputs the values in the elastic range, these values are multiplied by the deflection amplification factor,  $C_d$ , which gives us the value in the inelastic range. As can be seen from Table 2, the inelastic building drift calculated from the SAP2000 analysis is nearly half of the maximum allowable building drift. The building roof drift over the building height percent was 1.2%, which was expected from the structure as it has only three stories. The building drift always has to be checked for all structures in order to ensure that it is within the calculated restraints; as the height of the structure increases, so does the significance of the building drift check.



Table 2. Story drift from time history analysis.

Building Drift:		
Elastic building roof drift	.89	in
Inelastic building roof drift	5.35	in
Maximum allowable building drift	10.8	in
Roof drift over building height %	1.2	%

### Project Assessment

To obtain a quantitative assessment of the project and further improve the project in the future, an exit survey was conducted for all sixteen students participating the CiPair program including another twelve students in the mechanical, computer and electrical engineering. Students were asked to rate their level of agreement with each question in a five-point scale: 1 – Not at all useful; 2 – A little; 3 – Some; 4 – Quite a bit; 5 – A lot. The tables below present the students' response to the survey questions. The survey was conducted anonymously to encourage candid responses to the survey.

**Question:** How useful were each of the following activities during your internship?

Activity	Average Rating
Opening Day	4.75
Faculty Adviser Description of Project	4.88
Meetings with Graduate Student Mentor	4.88
Meetings with Faculty Adviser	4.63
Weekly Progress Reports	4.00
Presentations to SEI (high school) students	4.38
Mid-Program Presentations	4.53
Final Presentations at SFSU	4.81

**Question:** How satisfied are you with each of the following?

Activity	Average Rating
Opening Day at NASA Ames	4.06
Opening Day at SFSU	4.63
The project/topic you worked on	4.69
The results of your project	4.69
Your final poster:	4.56
Your final presentation	4.56
How much you learned from the program	4.75
Your group mates	4.38
Your graduate student mentor	4.88
Your faculty adviser	4.69
The Summer Internship Program as a whole	4.75

**Question:** As a result of your participation in the program, how much did you learn about each of the following?

<b>Activity</b>	<b>Average Rating</b>
Performing research	4.94
Designing/performing an experiment	4.88
Creating a work plan	4.81
Working as a part of a team	4.81
Writing a technical report	4.63
Creating a poster presentation	4.69
Making an oral presentation	4.81

**Question:** Tell us how much you agree with each of the following statements.

<b>Activity</b>	<b>Average Rating</b>
The internship program was useful.	4.94
I believe that I have the academic background and skills needed for the project.	4.63
The program has helped me prepare for transfer.	4.88
The program has helped me solidify my choice of major.	4.81
The program has helped me solidify my choice of transfer university.	3.75
As a result of the program, I am more likely to consider graduate school.	4.06
As a result of the program, I am more likely to apply for other internships.	4.94
As a result of the program, I am more likely to consider SFSU as my transfer institutions, or recommend it to others.	3.75
I am satisfied with the NASA CIPAIR Internship Program.	4.81
I would recommend this internship program to a friend.	4.88

When asked the question "what do you like most about the NASA CIPAIR Internship Program?" Typical response from the civil engineering group students are: "The subject was very interesting. It was a very real world experience of working in a team, meeting deadlines, and not having control over the quality of the deliverables. It was a new experience because I have never worked on something related with my major. It was good because I learned a lot of thing from my other coworkers; I like the opportunity that NASA CIPAIR has given to us to allow us to perform undergraduate research and immerse ourselves on a specific topic and became somewhat of an expert on the topic; I thoroughly enjoyed the work experience with the graduate students and Dr. Chen. Most of Dr. Chen's graduate students were very much helpful and we shared common interests. The challenge of working on something new and unguided was always rewarding."

### **Summary and Conclusion**

The CiPair program was very successful in helping student understand specific engineering topics and engineering profession. Responses from the student participants are very positive. Among the students who solidified their choice of an engineering career and decided to major in one of the engineering fields, the program has provided context to their study of engineering – a strategy that has been proven to increase student motivation and persistence – especially as they struggle through the first two years of the engineering curriculum.

**Acknowledgment**

This project is sponsored by NASA Office of Education through the Curriculum Improvement Partnership Award for the Integration of Research (CIPAIR), Grant Number NNX10AU75G.

**References**

1. Driver, Robert G., Geoffrey L. Kulak, D.J. Laurie Kennedy, and Alaa E. Elwi. "Cyclic Test of Four-Story Steel Plate Shear Wall." *Journal of Structural Engineering* (1998): 112-120. Print.
2. AISC Steel Construction Manual, 13th edition, 2005, ISBN 1-56424-055-X
3. ASCE/SEI 7-05 Minimum Design Loads for Buildings and Other Structures, 2006, ISBN 0-7844-0831-9
4. SAP2000. Computer and Structures Inc., 2012.
5. "Welcome to the PEER Ground Motion Database." PEER Ground Motion Database. N.p., 8 Nov. 2011. Web. 27 July 2013. <[http://peer.berkeley.edu/peer\\_ground\\_motion\\_database](http://peer.berkeley.edu/peer_ground_motion_database)>.

## Agile Development Using Cloud IaaS and PaaS in Computer Science Curricula

Gordon Romney, Pradip Dey, Mohammad Amin, and Bhaskar Sinha  
National University

### Abstract

Gartner, a leading IT industry analyst, finds that cloud Infrastructure-as-a-Service (IaaS) is the fastest-growing need of its clients. IaaS is a type of cloud computing service that parallels the infrastructure features of traditional IT data centers, and includes servers, firewalls, and routers for example. As IaaS has increased in utilization by industry, Platform-as-a-Service (PaaS), as a specialization that offers a computing platform and solution stack, has likewise evolved. Windows and Linux are examples of computing platforms, while an integrated combination of Windows, Apache, MySQL and PHP (WAMP) is a solution stack. Of necessity, successful students of IT and Computer Science disciplines must understand and be able to use the rapidly evolving cloud IaaS and PaaS. Higher education, however, is challenged in how to remain technologically current in courses offering rapidly evolving web services and cloud computing concepts. Such concepts can only be taught, properly, by experiential, hands-on learning by students using cloud computing resources. Fortunately, industry competition in cloud IaaS provides a free, limited time usage availability of virtualized cloud resources. The experience of both onsite and online students in graduate courses in Computer Science that utilized free technical resources of cloud IaaS providers for application and database development is analyzed in this paper. Analyzing and using cloud IaaS and PaaS resources by students in course assignments serves a dual purpose as it provides both instructional and industry-provider awareness. Pedagogical agility and the diversity, creativity and agility of the students, using distinctive programming skills in developing web server and mobile applications, are reviewed.

### Introduction

Gartner, the leading information technology and research advisory organization, stated that the “x86 virtualization infrastructure market is a foundation for two extremely important market trends: infrastructure modernization and cloud computing”<sup>1</sup>. One of the paper’s authors, Dey, as the Lead Faculty for the Masters in Computer Science (MS-CS) program of National University (NU), facilitated the inclusion of agility through virtualization in the curriculum of the DAT 605, Web and Cloud Computing (WCC) course.

*National University Class-per-Month Schedule.* NU offers WASC accredited onsite and online teaching modalities in a one semester course

delivered in a single calendar month. This is truly accelerated, Internet-time delivery of course material and becomes especially challenging to the engineering programs in the School of Engineering and Computing (SOEC)), and the Computer Science and Information Systems department. In universities, on a semester or quarter schedule, it is common to append a laboratory course to a course of instruction. In NU’s one-month format, the lab must be integrated into the instruction course. Agility in pedagogy becomes a necessity.

*Agile Pedagogy and Learning.* Pedagogical agility, agility in student assignments due to the one-course-per-month modality, and agility in software development processes have been introduced into SOEC curricula by the authors<sup>1,2,3,4,5,6</sup>. This has been an on-going process for seven years, and has made SOEC an agile “incubator”. The emphasis upon “Agility” in engineering and software development was signaled by the Agile Manifesto in 2001. Seventeen industry software engineers declared a change in the software development process. Thomas, one of the group of seventeen, became a noted Ruby on Rails evangelist and publisher<sup>8</sup>. Rails invites agility. Agile software development, unlike the rigid, sequential “waterfall” model for software development, consists of development methods based on incremental and iterative steps. In agile development, project requirements and solutions evolve through collaboration between cross-functional teams. It facilitates adaptive planning, development and delivery; a time-boxed iterative approach; and encourages nimble, immediate and flexible response to change. It is a conceptual framework that promotes synergistic interactions throughout the development cycle<sup>9</sup>. From a pedagogical or teaching perspective, the flexibility and ease of Rails development for a one-month course project has been consistently demonstrated in NU instruction, including DAT 605 Web and Cloud Computing<sup>10</sup>. Rails and agility are synonymous as Rails is an agile programming tool. Virtualization, in turn, made Rails easily demonstrable and useable in DAT 605 WCC as students could have their individual web server plus database server virtual machine on a local computer.

*Virtualization.* Virtualization technology allows a student to have an individual, dedicated “virtual” computer on which to experiment and complete a laboratory assignment without modifying, if desired, the host “physical” computer and its resources<sup>11</sup>. Operating system virtualization has been a great facilitator at SOEC in the teaching of computer science, information technology and security courses<sup>6,10</sup>. A physical, hypervisor host machine has the capability of running multiple operating systems concurrently, each of which is a guest machine or virtual machine (VM)<sup>12</sup>. Examples of a Hypervisor executing as an application are: 1) VMware Workstation under the Windows 8 O/S; 2) Parallels under the Mac OS X, or c) Oracle VirtualBox on Windows, Mac OS X or Linux. Virtual Labs (VL). Lab assignments using VMs have been especially important in the one-month- course modality at NU. From the first class of the month, students are able to immediately commence a virtual lab exercise comprised of, not only, an operating system but an entire application or solution stack such as WAMPP (WAMP plus Python)<sup>13</sup> or Instant Rails (Rails, MySQL, PHP)<sup>14</sup> installed on the VM. In DAT 605 WCC it is noteworthy that the introduction of a VM into the curriculum is, for the majority of the students, their first encounter with the technology and they are so excited at the prospects that virtualization offers in their employment opportunities and for their employer. Virtualization in DAT 605 WCC is used both on the student’s local computer as well as on public and private cloud services. Virtualization is part of the fundamental technology that has made cloud infrastructures possible and facilitated the rapid adoption of cloud concepts. Virtualization, however, is not a requirement for cloud implementation<sup>15</sup>. Google, as an example deployed a cloud architecture that does not use virtualization, but rather a bare-metal infrastructure in order to optimize server functionality.

*Cloud Technology.* Student learning is enhanced by agile use of technology<sup>2,3,4,16</sup>. Virtualization and deployment of cloud infrastructures go hand-in-hand with the use of agile pedagogy. Students in DAT 605 WCC were introduced to the NU SOEC private cloud, Virtual Education Lab (VEL)<sup>11</sup>, and a VM build of the Instant Rails stack<sup>14</sup>. In a subsequent DAT 605 WCC course, later in the year, when the VEL was temporarily unavailable because of load constraints, the students accepted the challenge to evaluate Cloud Service Providers

(CSP) and select one to use for the course project. This was agile pedagogy at its best. A cloud is not a place but it is a more agile method of deploying IT. Although VMs are provisioned to the user community by the CSP, cloud infrastructure is a new breed of purpose-built architecture. This paper focuses on three cloud service models: IaaS, PaaS and SaaS<sup>17</sup>.

*IaaS. Infrastructure-as-a-Service.* With the IaaS model, the CSP delivers computers, physical or virtual and other infrastructure resources such as storage, firewalls, IP addresses and bundled software. The cloud user normally has to provide patches and maintains their own operating systems. Example IaaS are Windows Azure, Amazon Web Services (AWS), Google Cloud, and HP Cloud.

*PaaS. Platform-as-a-Service.* With the PaaS model, the CSP delivers an operating platform that includes operating system, programming language execution environment, database, and web server. Management of the hardware and software layers is provided by the CSP and they scale to match the application demand such that the user does not have to manage them manually. Example PaaS are AWS Elastic Beanstalk, Google App Engine, and Windows Azure Compute.

*SaaS. Software-as-a-Service.* With the SaaS model, the CSP installs and operates the application software and cloud users access the software from cloud clients. Cloud users do not manage the cloud infrastructure and platform on which the application is running. Example SaaS are Google Apps, and Microsoft Office 365.

The first task for the DAT 605 WCC student was to evaluate and compare CSPs as shown in one response given in Table 1, “Comparison of Cloud Service Providers”<sup>18</sup>. Such a comparison facilitates the matching of student programming skills to the services provided by CSPs and the selection of the CSP that will provide the needed cloud resources for the course project.

Table 1. Comparison of cloud service providers

Provider	Amazon Web Services	Rackspace Hosting	Terremark	Microsoft Azure	Salesforce.com
Features					
Pay-As-You-Go	Yes	Yes	Yes	Yes	No
Prepaid	Annual	None	None	Quarterly	Monthly/User
Free	Requires Credit Card	None	None	Free Trial	Free Trial
Scaling	Auto/Configurable	Configurable	Configurable	Configurable	Auto
Data Transfer In	No Charge	No Charge	\$0.17/GB	No Charge	No Charge
Data Transfer Out	\$0.25/GB	\$0.18/GB	\$0.17/GB	\$0.145/GB	No Charge
Standard VM	VmWare	OpenStack	VmWare	None	None
Service Age	5+ Years	5+ Years	3 Years	1 Year	10+ Years
SLA	99.95%	100%	100%	99.95%	Per Contract

Private Cloud	Yes	Yes	Yes	Yes	No
Configurable Firewall	Yes	Yes	Yes	Yes	No
Tunnels	IPSec	SSH	IPSec	IPSec	None
Elasticity	Within Minutes	Linux Only	Pay for Performance	Pay for Performance	None
Developer Toolkit	Eclipse and Visual Studio	Proprietary API	Web	.NET, PHP, Java & more	Sales Toolkit
DB Tools	RDBs and Nosql	MySQL	MS SQL	ClearDB	None

### **DAT 605 Web and Cloud Computing Course**

The DAT 605 Web and Cloud Computing Course (WCC) is a course in the MS-CS program of SOEC with the following description: “A survey of the technologies required for software development of current applications, such as internet and client/server with a focus on database applications and software systems that solve a particular real-world problem. Examine application design and external, conceptual and internal levels of databases. Design and develop a front-end application using GUI/API, server-side and client-side programming, and multi-threading for modern relational databases in the client/server environment. Securing data in motion as well as at rest is designated the number one concern and priority by global enterprises.”<sup>19</sup> This paper has focused on the course learning outcome “Analyze and design complex front-end applications for cloud and client-server architectures”. The deliverable at the end of the month is a working cloud-based application that demonstrates a working knowledge of 1) virtualization techniques, 2) creation of a relational database with a minimum of five tables normalized to 3NF, 3) creation of a website using cloud technology with client-server architecture, and 4) security technology used in cloud technology. A sampling of projects from several courses is reviewed to illustrate the power and satisfaction of completing a hands-on prototype application.

### **DAT 605 Web and Cloud Computing (WCC) Projects**

*A Sample of WCC Project.* Table 2 specifies selected details of student course projects from the MS-CS program DAT 605 course on Web and Cloud Computing during 2012. The systematic and progressive introduction of virtualization, access to cloud service providers (CSP) and relational database normalization instructional topics challenged the programming skills of most students and accelerated them to a new level of excellence. They excitedly embraced the new development tools and their availability in the cloud. Refer to the following to better understand the notes of the five columns of the project Table 2:

*Project.* The first column provides the name given by the students to the month-long course project. The project assignment was to deliver and provide specific documentation to APA standards of an operational application that included 1) a web server (such as Apache), 2) a database server (such as MySQL), 3) use of virtualization technology (options were VMware, Oracle’s VirtualBox, or hypervisors supplied by cloud service providers, and 4) design a normalized relational database with at least five tables. Higher grades would be achieved if cloud resources were used in the solution.

Table 2. A sample of web and cloud course projects

	Project	Cloud Service Provider	Cloud Services	Database	Tools, Programming Language, O/S
1	Tennis Buddy	None	None only local cptr No VM	MySQL	Windows XP, Instant Rails, Apache
2	SignMeUp University System	None	None only local computer with VM	SQL Server Express	Visual Studio 2010, .NET, C#, WAMPP, Win XP VM on VMware Workstation 9
3	E-Classroom	MS Azure	IaaS, PaaS	SQL	Java/J2EE, Eclipse IDE, Windows
4	Online Bookstore	MS Azure	IaaS, PaaS	SQL	ASP.NET, C#, Sharepoint
5	Android Phone Remote Ctl	NU Private VEL	IaaS, PaaS	MySQL	VMware, MyVMware app, Android SDK
6	Android Phone User Registration	MS Azure	IaaS, PaaS	SQL	Visual Studio 2012, .NET, Java, Android SDK, Eclipse, Vis C#
7	Photo Share	MS Azure	IaaS, PaaS, SaaS	SQL, 3NF, Blobs, 6 Tables	Visual Studio 2012 C#, Windows
8	Scubamob	Amazon AWS Google Cloud	IaaS, PaaS	MySQL, 3NF 6 Tables	Python, Django, LAMP, Cent OS, Google App Engine
9	Word Problem	Amazon AWS	IaaS, PaaS	MySQL, 3NF 6 Tables	AppFog, Rails, LAMP, PhpMyAdmin

*Cloud Service Provider (CSP).* The CSP was the technology provider of the cloud services used. Projects 1 and 2 used a laptop or desktop for development and no cloud services were used. Project 1 was a local build without virtualization but projects 2-9 all used a hypervisor and virtual machine in some way.

*Cloud Services.* The particular cloud computing service models provided by the CSP that were used are specified: IaaS (Infrastructure as a Service), PaaS (Platform as a Service) and SaaS (Software as a Service). Virtual machine usage for web servers or database servers are part of IaaS and Amazon Web Services' (AWS) Elastic Compute Cloud (EC2), Windows Azure and Rackspace are IaaS examples. .NET framework is a PaaS with Azure Cloud Services and Azure Web Sites as examples. AWS Elastic Beanstalk and Google App Engine are others. For SaaS Google Apps, Microsoft Office 365 and Visual Studio 2012 are examples<sup>20</sup>.

*Database.* The relational database management system used in the project. MySQL and SQL Server are examples. Blobs are very large (Giga bytes) unstructured data such as videos. 3NF denotes the database normalized to third normal form and the number of tables that were used in the project.

*Tools, Programming Language and O/S, Operating System.* Students used largely open-source resources as tools and languages that were free and that they had experience using. Among tools the following are listed: 1) O/S and web stacks such as Instant Rails, WAMPP and LAMP<sup>13,14</sup>. These facilitate the production of an operating web environment that includes an O/S such as



Windows or Linux; a web server such as Apache; database server such as MySQL; PhP, Ruby/Rails and Python scripting languages; Visual Studio; .NET; Android Software Development Kit (SDK); Eclipse; Django; VMware; MyVMware app; AppFog; Sharepoint; phpMyAdmin; 2) Programming languages such as Ruby/Rails, C#, Java, Python, Visual C#; and 3) O/S such as Windows XP, 7, 8; and Linux including Ubuntu and Cent OS.

*Progression of Instructional Topics.* One author, Romney, experimented with the capacity of students to assimilate new and challenging technical skills by gradually taking the students from an introduction to virtualization on a local computer (laptop or desktop) to using 90-day free CSP IaaS resources to host a remote virtual machine for the month-long project. Table 3, “Progression of Instructional Types” shows the progression by the four instructional topics of the sampling of projects that was made possible by the emergence and availability of public IaaS resources. The progression was from (1) local virtualization to (2) remote virtualization on (a) public cloud or (b) private cloud (NU’s VEL)<sup>11</sup> to (3) relational database normalization. The results were overwhelmingly validated by the students who were, on first exposure to the cloud, pleased with the flexibility and productivity it introduced for application development.

Table 3. Progression of instructional topics

Progression	Instructional Topic	Project
1	Local Virtualization	1 & 2
2	Public Cloud	3 - 9
2	Private Cloud	5
3	Relational Database Normalization	7 - 9

*Inclusion of relational database normalization.* The inclusion of relational database normalization had little to do with the cloud technical issues but did have relevance to web application deployment and the fact that DAT 605, Web and Cloud Computing (WCC), immediately follows the MS-CS course DAT 604, Database Design and Implementation (DDI). The value of understanding database normalization is that the skill assists database designers to always have a database that accommodates SQL operations that can be reversed to produce the original database. Codd based his relational model on sound mathematical principles as a normalized database forms an Abelian group and all operations are commutative<sup>21</sup>. Amin, one of the authors, frequently taught DAT 604 DDI and used a very effective teaching method for database normalization. Romney, another author of this paper, in turn taught DAT 605 WCC and reinforced the normalization concepts and approach learned the month before by having the students employ them in creating a web and cloud application by normalizing the database to third normal form (3NF)<sup>22</sup>. This reinforcement of a process learned with added increased-complexity to a level of mastery of a learning outcome by hands-on application to a real-world problem has proved to be most satisfying to the students and beneficial to their long-term retention of sound principles correctly taught.

### **A Summary of Select DAT 605 Web and Cloud Computing Cloud Project Successes**

*Project 7: Photo sharing application.* Project 7 was conceived to be a Photo Sharing application and was described as having the objective of sharing pictures online in a cloud platform environment and eliminate the need to manage large quantities of data on a USB or other

portable memory device<sup>23</sup>. MS Azure Cloud was used and a 3NF normalized SQL database was designed. An innovation the team implemented was the use of Windows Azure Blob Storage where a single blob can be hundreds of gigabytes in size and a single account can hold up to 100 TB of data. Figure 1 illustrates the complexity of data anomalies for this application using two initial tables.

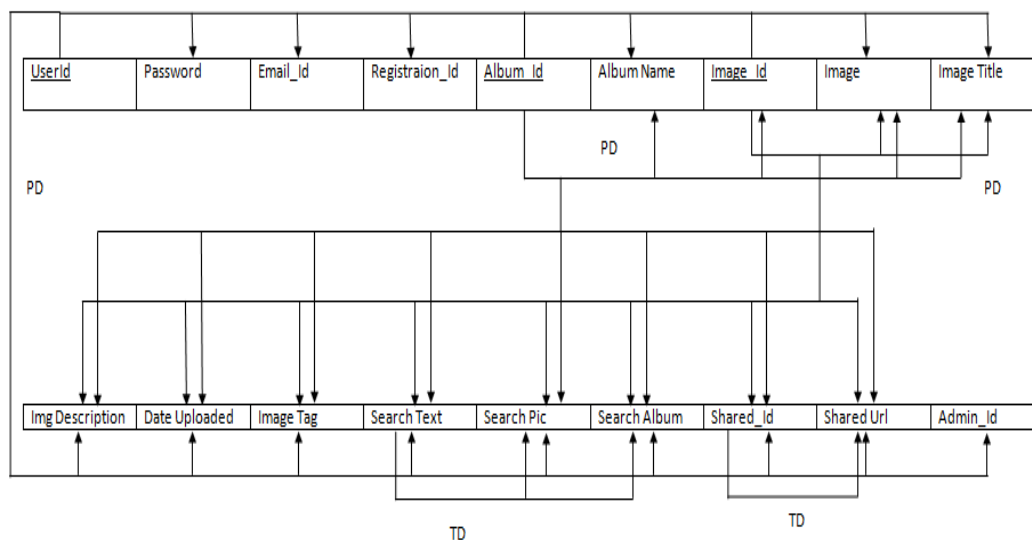

Figure 1. First normal form (1NF) of photo sharing project.

Applying the process taught by Amin in DAT604 DDI and Romney in DAT605 WCC the students eliminated anomalies in the SQL relational database table structure by normalization to third normal form (3NF) as shown in Figure 2.

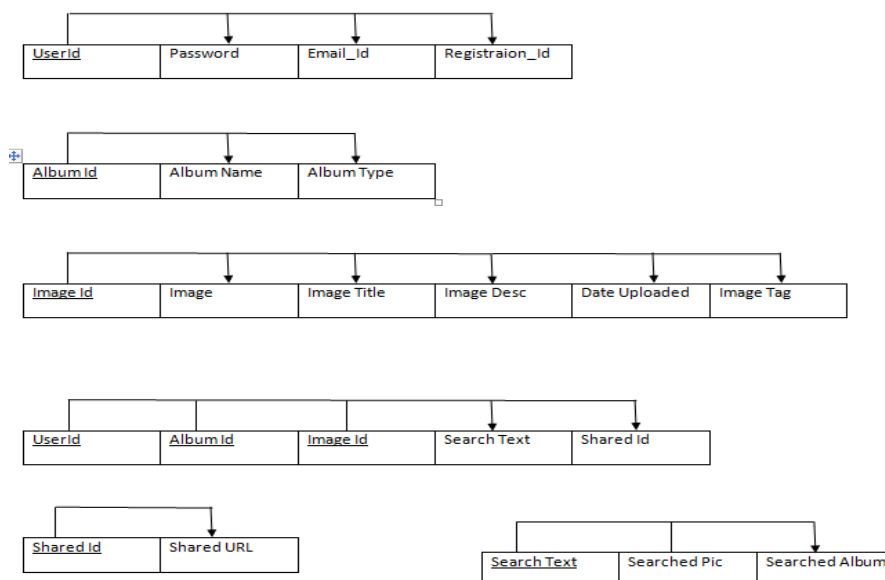

Figure 2. Third normal form (3NF) of photo sharing project.

The Windows Azure website was occasionally down so the team took advantage of publishing to multiple servers hosted on different Azure locations in order to keep the website up at all times.

Connection security between cloud storage and the user account was a concern so they implemented the Security Token Service (STS) feature that provides a digital signature for each authentication token for every user.

*Project 8: Scubamob.* Project 8 was created using two different CSPs, Amazon AWS and Google Cloud, to facilitate dive information for scuba divers such as dive sites, dive history, dive locations, climate and log records<sup>24</sup>. A Linux stack, LAMP, was created using AWS IaaS with six MySQL 3NF tables; and Google Apps, a PaaS, from Google Cloud was used to employ the GPS feature of Google Maps from Google App Engine as shown in Figure 3.

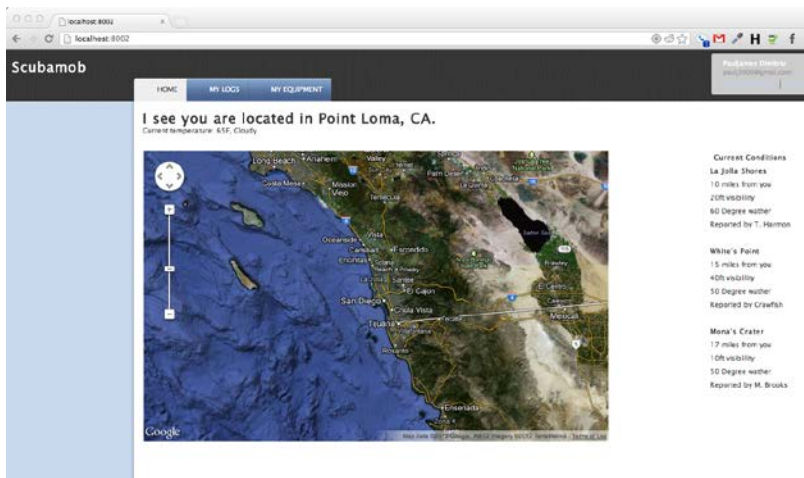

Figure 3. Google maps used to determine dive locations.

*Project 9: Word problem studio.* Project 9 was a mathematics teaching aid for word problems that made use of AppFog, a PaaS application built on a LAMP, Linux stack, web platform that ran on Amazon Web Services, a CSP that made the IaaS functions from an east coast location available. The team was particularly pleased to discover that this CSP used Rails as its configuration management platform. MySQL was used as the relational database for the project.

*Project 5: Android phone remote control.* Project 5 used the National University Virtual Education Lab (VEL) private cloud to implement an Android application that provided authentication using the VEL VPN and digital certificate to access the VEL and VMware management of a virtual machine, VM, located in the VEL<sup>11,26</sup>. This clever project paves the way for future research that would allow an Android smartphone to remotely control a VM.

*Project 6: Android phone user registration.* Project 6 used MS Azure and its IaaS and PaaS features to program using the Android Software Development Kit, Java and Visual C#. The outcome is a data entry screen on the Android that allows a user to type in UserName, Gender, and PhoneNumber for registration on some websites which, in turn, was stored in a SQL relational database created and stored on Azure. The team used a VM for both the website setup as well as the application and used the power of Microsoft Visual studio 2012 Express to develop and publish this small business solution. The fact that Visual Studio was integrated into MS Azure PaaS and was free for a trial period made the project possible. Figure 4 shows the Software Development Kit image on the virtual machine and the actual Android phone image on the right. Like many students in this course, this team used a virtual machine to program a project for the

very first time and were pleased with the productivity of cloud-based development tools<sup>27</sup>.

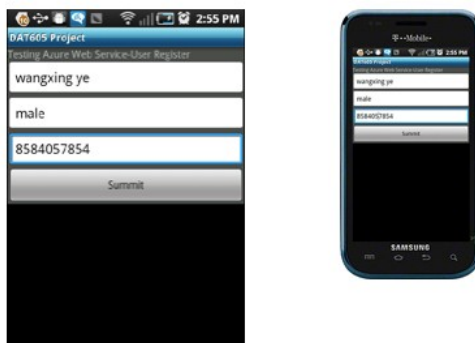

Figure 4. Android phone user registration images.

### Conclusions

SOEC has developed into an incubator for agile pedagogy, virtualization and private and public cloud experimentation in both onsite and online education. The use of hypervisors and virtualization has increased the agility, flexibility and efficiency of the MS-CS program at NU through hands-on-learning. Additionally, the usage of Cloud Service Providers, with trial subscriptions, has ignited the creativity of the students. By evaluating their specific programming skills, matching them to the appropriate CSP, and selecting them to one or more IaaS or PaaS providers students produced remarkable results. Reinforcing what the students had previously learned in DAT 604, Database Design and Implementation, by reviewing the normalization process and implementing it in the project, definitely led to improved retention and mastery of the subject as the quality of the projects illustrated. Success is infectious as a spirit of collaboration and assistance prevailed between teams of students.

The creativity demonstrated in the two Android projects was most gratifying. The projects were definitely the final assignment but three other assignments that contributed material for completing the project and a Power Point report on a cloud or cloud security topic in addition to quizzes, a midterm and final exam all contributed to achieving the learning outcomes for the course. Learning about the developing field of cloud technology and actually implementing it as in the instance of Scubamob by using Google Maps and GPS technology to identify a dive location is absolute fun. When learning is fun knowledge retention only increases.

### Recommendations for Future Research

Each new class of DAT 605 WCC offers new opportunities as the options are truly limitless. Project 5 suggests learning to remotely control a VM from a smartphone. Controlling a device such as a Raspberry Pi processor running Kali Linux with its penetration testing tools from a smartphone through the cloud is a challenging, yet doable prospect.

### Acknowledgments

The authors are grateful to the National University administration, staff and faculty for providing support for the VEL virtual laboratory. As a group of SOEC faculty, the authors experience a remarkable level of mutual collaboration/collegiality that builds on their teaching and research.

## References

1. Gartner (2013). IaaS Cloud Magic Quadrant, Retrieved November 25, 2013 from [http://www.gartner.com/technology/reprints.do?id=1-1I5JDYG&ct=130805&st=sb&elq\\_mid=&elq\\_cid=1062703](http://www.gartner.com/technology/reprints.do?id=1-1I5JDYG&ct=130805&st=sb&elq_mid=&elq_cid=1062703)
2. Romney, G.W. (2009). The Integration of Ruby on Rails as an Agile Teaching Tool in IT Curricula. *ASEE/PSW-2009 Conference*, San Diego, CA
3. Dey, P., Gatton, T., Amin, M., Wyne, M., Romney, G., Farahani, A., & Cruz, A., (2009). Agile problem Driven Teaching in Engineering, Science and Technology. *ASEE/PSW-2009 Conference*, San Diego, CA.
4. Sahli, M.A., & Romney, G.W. (2010). Agile Teaching: A Case Study of Using Ruby to Teach Programming Language Concepts, *National University Journal of Research in Innovative Teaching*, La Jolla, CA 3(1), 63.
5. Dey, P. P., Romney, G., Amin, M., Sinha, B., Gonzales, R., Farahani, A., & Subramanya, S.R. (2012). A Structural Analysis of Agile Problem Driven Teaching, *National University Journal of Research in Innovative Teaching*, 5, 89-105.
6. Romney, G.W., Dey, P.P., Amin, M., & Sinha, B.R. (2013). The Flexibility, Agility and Efficiency of Hypervisors in Cyber Security Education, *IEEE ITHET 2013 Conference*, Antalya, Turkey, IEEE Xplore 10.1109/ITHET.2013.6671036
7. Agile Manifesto (2001). Retrieved from <http://agilemanifesto.org/> February 2001
8. Thomas, D., Hansson, D., Breedt, L, Davidson, J., Schwarz, A., Gehrtland, J. & Clark, M. (2006). *Agile Web Development with Rails, 2<sup>nd</sup> Edition*, The Pragmatic Bookshelf,
9. Agile (2013). Agile Software Development, Retrieved from [http://en.wikipedia.org/wiki/Agile\\_software\\_development](http://en.wikipedia.org/wiki/Agile_software_development)
10. Romney, G., Romney, M., Sinha, B., Dey, P., & Amin, M. (2014). The Power of Rails and Industry Collaboration in Cyber Education, *National Cybersecurity Institute Journal*, April 2014, Washington, D.C. In Press
11. Anderson, R.C. & Romney, G.W. (2013). Comparison of Two Virtual Education Labs – Closing the Gap Between Online and Brick-and-Mortar Schools, *IEEE ITHET 2013 Conference*, Antalya, Turkey. IEEE Xplore 10.1109/ITHET.2013.6671035
12. NIST.gov. (January, 2011). Special Publication 800-125: Guide to security for full virtualization technologies. Retrieved August 2, 2013 from <http://csrc>
13. WAMP (2014). WAMP stack, Retrieved January 20, 2014, from <http://sourceforge.net/projects/wampserver>.
14. Rails (2014). Bitnami Ruby Stack replaced Instant Rails, Retrieved January 20, 2014, from <http://instantrails.rubyforge.org/wiki/wiki.pl>
15. Citrix (2014). Citrix cloud is not, Retrieved January 28, 2014, from [http://assets.citrix.com/t5\\_sem/typ/Cloud-is-not-whitepaper.pdf](http://assets.citrix.com/t5_sem/typ/Cloud-is-not-whitepaper.pdf)
16. Katz (2011). “The Tower and the Cloud,” Retrieved September 26, 2013 from <http://net.educause.edu/ir/library/pdf/pub7202.pdf>
17. IJETA (2013). Survey on Cloud Computing, Retrieved January 28, 2014 from [http://www.ijetae.com/files/Volume3Issue4/IJETA\\_0413\\_53.pdf](http://www.ijetae.com/files/Volume3Issue4/IJETA_0413_53.pdf)
18. CSP Comparison (2012). Analysis for DAT605 on file at National University.
19. NU Catalog 77 (2013). Retrieved from <http://www.nu.edu/assets/resources/pageResources/Catalog77.pdf>, 371
20. Gartner (2014). Retrieved from <http://www.gartner.com/technology/reprints.do?id=1-G0FWUJ&ct=130613&st=sg>
21. Codd (1970). A Relational Model of Data for Large Shared Data Banks, Retrieved from <http://www.seas.upenn.edu/~zives/03f/cis550/codd.pdf>
22. Normalization (2014). Agile Data: Introduction to Data Normalization: A Database “Best” Practice, Retrieved from <http://agiledata.org/essays/dataNormalization.html>
23. Photo (2012). Photo Sharing DAT 605 project on file at National University.
24. Scubamob (2012). Scubamob DAT 605 project on file at National University.
25. Studio (2012). Word Problem Studio DAT 605 project on file at National University.
26. Remote-Control (2012). Android Phone Remote Control DAT 605 project on file at National University.
27. Registration (2012). Android Phone User Registration DAT 605 project on file at National University.

## **Evaluation of Modal Analysis for Time-Delayed Multi-Degree of Freedom Structures for Reliability Assessment of Real-Time Hybrid Simulation Results**

Frank Sanchez and Cheng Chen  
San Francisco State University

### **Abstract**

Real-Time Hybrid Simulation (RTHS) presents an innovative technique for earthquake engineering research that enables researchers to assess structural performance through component tests. Servo-hydraulic dynamics induced time delay can lead to synchronization errors between the experimental and analytical substructures. This makes it necessary to perform reliability assessment of RTHS results to appropriately interpret structural performance subjected to selected ground motion. Research findings from previous studies on single-degree-of-freedom (SDOF) structures is not directly applicable due to multiple mode participation when the RTHS involves multiple-degree-of-freedom (MDOF) structures. Integrated with the engineering senior project at San Francisco State University and supported by the NSF BRIGE project, this study presents computational analysis of RTHS of a two-degree-of-freedom structure by a senior civil engineering student. Modal analysis developed for linear elastic structures is evaluated for time-delayed RTHS of nonlinear MDOF structures. Frequency response analysis is also utilized to decouple the MDOF into multiple SDOFs. It is demonstrated that modal analysis has potential for reliability assessment of RTHS involving multiple experimental substructures. The computational study presented herein exemplifies engaging engineering student into advanced earthquake engineering research to solve a real practical problem. The integration with senior design project provides an exploration for undergraduate institutions such as San Francisco State University to recruit and involve motivated engineering students into research and to prepare them for advanced degrees.

### **Introduction**

Experiments are critical for structural hazard mitigation. However, traditional seismic experiments could be very expensive and are often constrained by limited laboratory space. Shake-table tests allow researchers to simulate an earthquake on an entire scaled building. These tests require a large laboratory, very expensive equipment, and the cost to replace the yielded members of the structure in between simulations could be prohibitive. Real-time hybrid simulation (RTHS) is an efficient alternative to the shake table test. Instead of testing an entire structure in the laboratory, RTHS divides the structure into experimental and analytical substructures. The experimental substructures are physically tested in the laboratory while the analytical substructures are modeled numerically in computer programs. Figure 1 presents the general concept of RTHS in relation to a full scale test.

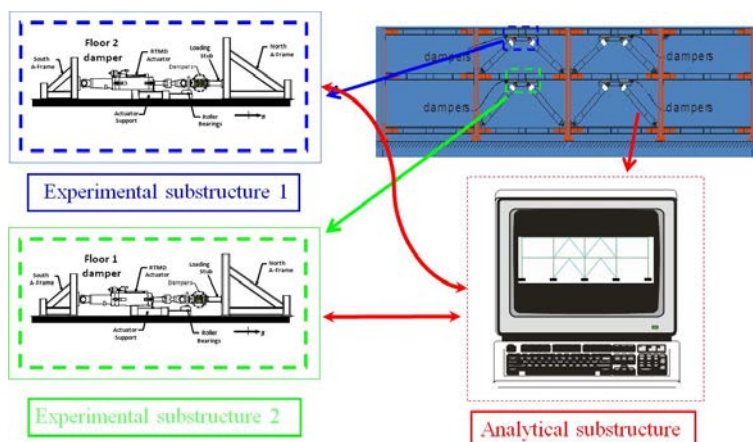

Figure 1. Schematic of RTHS for a moment resisting frame with energy dissipation devices.

Servo-hydraulic actuators are often used to apply desired responses to the experimental substructures. However, a time delay caused by the hydraulic actuators during the test can lead to a synchronization error between the two substructures. The time delay is caused by the servo-hydraulics not being able to reach the desired positions in a real-time manner<sup>1</sup>. In order for RTHS results to be accurate and reliable, this time delay must be accounted for throughout the test. Nonlinear hydraulic dynamics and inelastic structural behavior however make it difficult to estimate the time delay accurately before the simulation<sup>2</sup>. Research was previously conducted on the reliability of RTHS for a SDOF structure. Findings from previous studies on SDOF structures are not directly applicable to a MDOF structure due to multiple modal participation. RTHS of a MDOF structure requires that hydraulic actuators produce desired responses at each story, thus inducing multiple actuator delays<sup>3</sup>. Modal analysis technique is often used by researchers to analyze linear elastic structural dynamics under vibrational excitation. This method uses the overall mass and stiffness of each mode of the structure to find the various periods at which it will naturally resonate. To apply the modal analysis technique for RTHS reliability analysis, the effect of time delay and nonlinear structural behavior need to be investigated. This paper presents preliminary studies to evaluate the modal analysis technique for RTHS involving multiple actuator delay.

### Modal Analysis for Linear Elastic Structures

For a linear elastic MDOF structure, the equation of motion can be represented as:

$$\underline{\mathbf{M}} \cdot \ddot{\underline{\mathbf{x}}} + \underline{\mathbf{C}} \cdot \dot{\underline{\mathbf{x}}} + \underline{\mathbf{K}} \cdot \underline{\mathbf{x}} = \underline{\mathbf{F}} \quad (1)$$

where  $\underline{\mathbf{M}}$ ,  $\underline{\mathbf{C}}$  and  $\underline{\mathbf{K}}$  are the mass, viscous damping and stiffness matrices, respectively;  $\ddot{\underline{\mathbf{x}}}$ ,  $\dot{\underline{\mathbf{x}}}$  and  $\underline{\mathbf{x}}$  are the acceleration, velocity and displacement response, respectively; and  $\underline{\mathbf{F}}$  is the external excitation force vector applied on the structure. For a 2DOF structure; the mass matrix, stiffness matrix, damping matrix and equations of motion can be expressed as

$$\underline{\mathbf{M}} = \begin{bmatrix} m_1 & 0 \\ 0 & m_2 \end{bmatrix} \quad (2a)$$

$$\underline{\mathbf{C}} = \mathbf{a}_0 \cdot \underline{\mathbf{M}} + \mathbf{a}_1 \cdot \underline{\mathbf{K}} = \begin{bmatrix} c_{11} & c_{12} \\ c_{21} & c_{22} \end{bmatrix} \quad (2b)$$

$$\underline{\mathbf{K}} = \begin{bmatrix} k_1 + k_2 & -k_2 \\ -k_2 & k_2 \end{bmatrix} \quad (2c)$$

$$m_1 \cdot \ddot{x}_1 + c_{11} \cdot \dot{x}_1 + c_{12} \cdot \dot{x}_2 + k_1 \cdot x_{1m} + k_2 \cdot (x_1 - x_2) = F_1 \quad (3a)$$

$$m_2 \cdot \ddot{x}_2 + c_{21} \cdot \dot{x}_1 + c_{22} \cdot \dot{x}_2 + k_2 \cdot (x_2 - x_1) = F_2 \quad (3b)$$

where  $m_1$  and  $m_2$  are the mass of the first and second story of the 2DOF structure, respectively;  $k_1$  and  $k_2$  represent the story stiffness;  $c_{11}$ ,  $c_{12}$ ,  $c_{21}$  and  $c_{22}$  represent the viscous damping inherent to the structure;  $F_1$  and  $F_2$  represent the external excitation force on the structure; and  $x_1$  and  $x_2$  represent the command (exact) displacement of the first and second story<sup>4</sup>.

For modal analysis, the coupled 2DOF structure is converted into two separate SDOF structures by using modal decomposition. Assuming that the structure in Eq. 1 has the mode shapes  $\underline{\phi}_1$  and  $\underline{\phi}_2$ , the equations of motion in Eq. 1 can be rewritten as,

$$\underline{\phi} = [\underline{\phi}_1 \quad \underline{\phi}_2] = \begin{bmatrix} \phi_{11} & \phi_{12} \\ \phi_{21} & \phi_{22} \end{bmatrix} \quad (4)$$

$$\underline{\mathbf{q}}(\mathbf{t}) = \underline{\phi}^{-1} \cdot \underline{\mathbf{x}}(\mathbf{t}) \quad (5)$$

$$\underline{\mathbf{M}}_1 \cdot \ddot{\mathbf{q}}_1 + \underline{\mathbf{C}}_1 \cdot \dot{\mathbf{q}}_1 + \underline{\mathbf{K}}_1 \cdot \mathbf{q}_1(\mathbf{t}) = \underline{\mathbf{F}}_{1q}(\mathbf{t}) \quad (6a)$$

$$\underline{\mathbf{M}}_2 \cdot \ddot{\mathbf{q}}_2 + \underline{\mathbf{C}}_2 \cdot \dot{\mathbf{q}}_2 + \underline{\mathbf{K}}_2 \cdot \mathbf{q}_2(\mathbf{t}) = \underline{\mathbf{F}}_{2q}(\mathbf{t}) \quad (6b)$$

where  $q_1$  and  $q_2$  are the modal displacements and are computed using the mode shapes and the coupled command displacements of the 2DOF structure;  $x_1$  and  $x_2$ .  $M_1$  and  $M_2$  are the modal masses for the first and second mode, respectively, and are computed as  $\underline{\mathbf{M}}_1 = \underline{\phi}_1^T \cdot \underline{\mathbf{M}} \cdot \underline{\phi}_1$  and  $\underline{\mathbf{M}}_2 = \underline{\phi}_2^T \cdot \underline{\mathbf{M}} \cdot \underline{\phi}_2$ ;  $C_1$  and  $C_2$  are the modal damping for the first and second mode, respectively, and are computed as  $\underline{\mathbf{C}}_1 = \underline{\phi}_1^T \cdot \underline{\mathbf{C}} \cdot \underline{\phi}_1$  and  $\underline{\mathbf{C}}_2 = \underline{\phi}_2^T \cdot \underline{\mathbf{C}} \cdot \underline{\phi}_2$ ;  $K_1$  and  $K_2$  are the modal stiffness for the first and second mode, respectively, and are computed as  $\underline{\mathbf{K}}_1 = \underline{\phi}_1^T \cdot \underline{\mathbf{K}} \cdot \underline{\phi}_1$  and  $\underline{\mathbf{K}}_2 = \underline{\phi}_2^T \cdot \underline{\mathbf{K}} \cdot \underline{\phi}_2$ ;  $F_{1q}$  and  $F_{2q}$  are the modal excitation force for the first and second mode, respectively, and are computed as  $\underline{\mathbf{F}}_{1q} = \underline{\phi}_1^T \cdot \underline{\mathbf{F}}$  and  $\underline{\mathbf{F}}_{2q} = \underline{\phi}_2^T \cdot \underline{\mathbf{F}}$ <sup>4</sup>.

Eqs. 7-8 are used to relate the modal displacements of the SDOF structures,  $q_1$  and  $q_2$ , to the command displacements of the 2DOF structure,  $x_1$  and  $x_2$ . The variables  $x_{1q}$  and  $x_{2q}$  represent the displacement responses of the two SDOF structures after modal analysis<sup>4</sup>.

$$\underline{x}_q = \underline{\phi} \cdot \underline{q} \quad (7)$$

$$x_{1q} = q_1 \cdot \phi_{11} + q_2 \cdot \phi_{12} \quad (8a)$$

$$x_{2q} = q_1 \cdot \phi_{21} + q_2 \cdot \phi_{22} \quad (8b)$$



The accuracy of the modal decomposition can be determined by measuring the error between the modal displacements,  $x_{1q}$  and  $x_{2q}$ , and the story displacements,  $x_1$  and  $x_2$ .

### Real-Time Hybrid Simulation with Actuator Delay

When the servo-hydraulic actuators have time delays during the RTHS, the structure dynamics can be modified as

$$\begin{bmatrix} m_1 & 0 \\ 0 & m_2 \end{bmatrix} \begin{Bmatrix} \ddot{x}_1 \\ \ddot{x}_2 \end{Bmatrix} + \begin{bmatrix} c_{11} & c_{12} \\ c_{21} & c_{22} \end{bmatrix} \begin{Bmatrix} \dot{x}_1 \\ \dot{x}_2 \end{Bmatrix} + \begin{bmatrix} k_1 + k_2 & -k_2 \\ -k_2 & k_2 \end{bmatrix} \begin{Bmatrix} x_{1m}(t - \tau_1) \\ x_{2m}(t - \tau_2) \end{Bmatrix} = \begin{Bmatrix} F_1(t) \\ F_2(t) \end{Bmatrix} \quad (9)$$

where  $\tau_1$  and  $\tau_2$  are the delays due to the servo-hydraulic actuators attached to the experimental substructures in the first and second story, respectively;  $x_{1m}$  and  $x_{2m}$  represent the measured (delayed) displacement response in the first and second story, respectively. It can be observed that the actuator delays associated with the experimental substructures in the 2DOF are coupled. If the modal analysis remains valid, the equations of motion in Eq. 9 can be rewritten as

$$M_1 \cdot \ddot{q}_1 + C_1 \cdot \dot{q}_1 + K_1 \cdot q_{1m}(t - \tau_{q1}) = F_{1q}(t) \quad (10a)$$

$$M_2 \cdot \ddot{q}_2 + C_2 \cdot \dot{q}_2 + K_2 \cdot q_{2m}(t - \tau_{q2}) = F_{2q}(t) \quad (10b)$$

where  $\tau_{1q}$  and  $\tau_{2q}$  are the average delay to be computed from the modal displacements,  $q_{1m}$  and  $q_{2m}$ , by frequency domain analysis. The accuracy of the modal decomposition can be determined by measuring the error between the modal displacements,  $x_{1q}$  and  $x_{2q}$ , and the measured story displacements,  $x_{1m}$  and  $x_{2m}$ . The computational simulation in the following section will be utilized to validate the accuracy of modal analysis for the linear elastic structures with time delays.

### Computational Simulation for Linear Elastic MDOF Structure

A Matlab/Simulink model was created for computational simulation of a 2DOF linear elastic structure. The input for the model is the external excitation forces and the output is the displacements for each story. Transport delay blocks are incorporated into the model to represent the time delay due to the servo-hydraulic actuators. Figure 2 shows the comparison of the story displacements with and without the incorporation of actuator delay. The ground motion used in this simulation is the 1994 Northridge earthquake recorded by USC in Beverly Hills with a peak ground acceleration of 0.4158 g. The delay incorporated is 3 ms at the first story and 3 ms at the second story. The structure has the natural frequencies of 3.88 rad/s and 10.17 rad/s. The structure is assumed to have Rayleigh viscous damping of 2% for both the first and second story.

Figure (2a) and Figure (2c) represent the command vs. measured displacement at the first and second story, respectively; and Figure (2b) and Figure (2d) represent displacement response error at the first and second story, respectively. The maximum displacement error is 20.5% for the first story and 16.7% for the second story. This proves that very small actuator delays can have major effects on the accuracy of RTHS results.

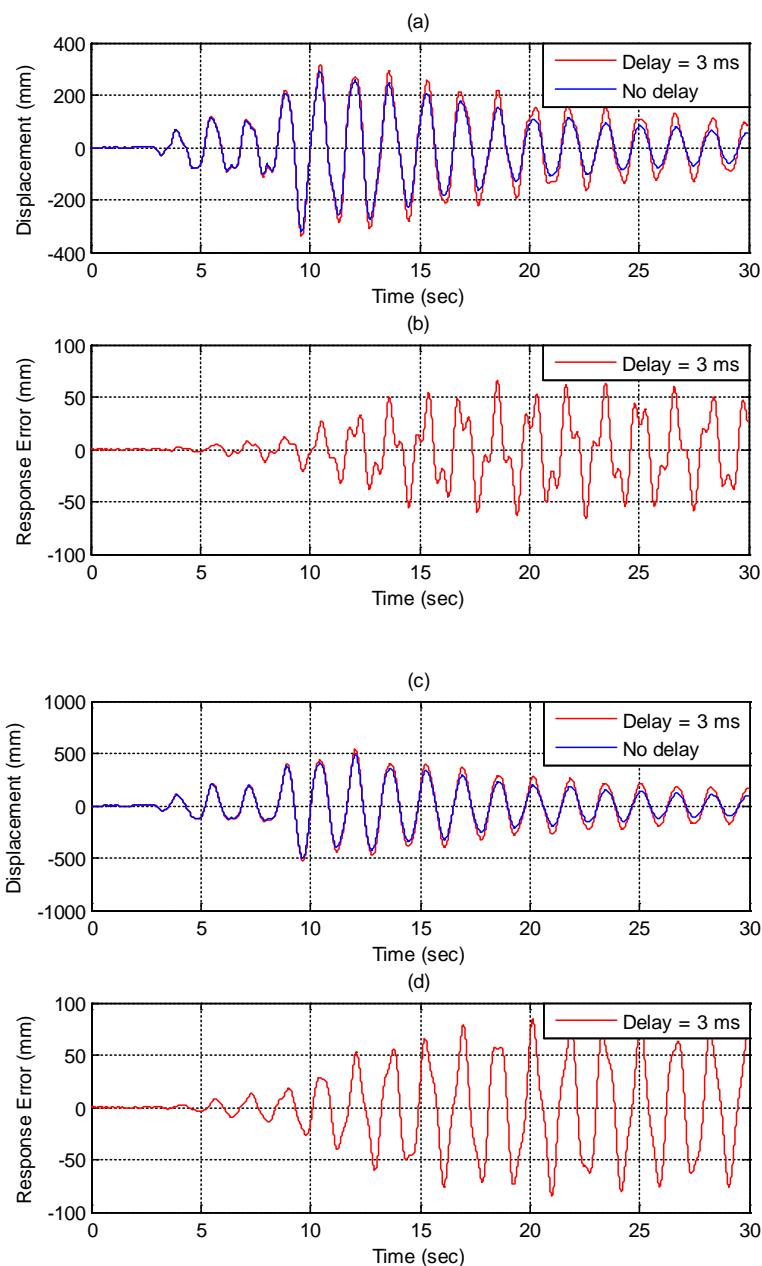

Figure 2. Effect of actuator delay on inear 2DOF structure in RTHS.

After the 2DOF model returns the measured displacements  $x_{1m}$  and  $x_{2m}$ , they are converted into modal displacements  $q_{1m}$  and  $q_{2m}$  by using modal decomposition Eqs. 4-5. Frequency domain analysis is used to compute the average time delay,  $\tau_{q1}$  and  $\tau_{q2}$ , from these modal displacements as two separate SDOF structures<sup>5</sup>. The equivalent mass, stiffness, damping and external excitation forces of these SDOF structures is computed based on modal analysis technique. The SDOF model uses Eqs. 10a-10b to compute the modal displacement,  $q_{1m}$  and  $q_{2m}$ , of the first and second SDOF structure when subjected to actuator delay,  $\tau_{q1}$  and  $\tau_{q2}$ , respectively. Eqs 7-8 are used to relate the modal displacements of the SDOF structures,  $q_{1m}$  and  $q_{2m}$ , to the measured displacements of the 2DOF structure,  $x_{1m}$  and  $x_{2m}$ . The variables  $x_{1q}$  and  $x_{2q}$  represent the displacement responses of the two SDOF structures after modal analysis. In comparison to the

measured displacements  $x_{1m}$  and  $x_{2m}$  of the 2DOF structure, the modal analysis displacements  $x_{1q}$  and  $x_{2q}$  are almost identical. Figure 3 shows the comparison of the 2DOF measured displacements with the SDOF modal analysis displacements. The same ground motion and parameters from the previous simulation are used. The delay incorporated is 3 ms at the first story and 3 ms at the second story.

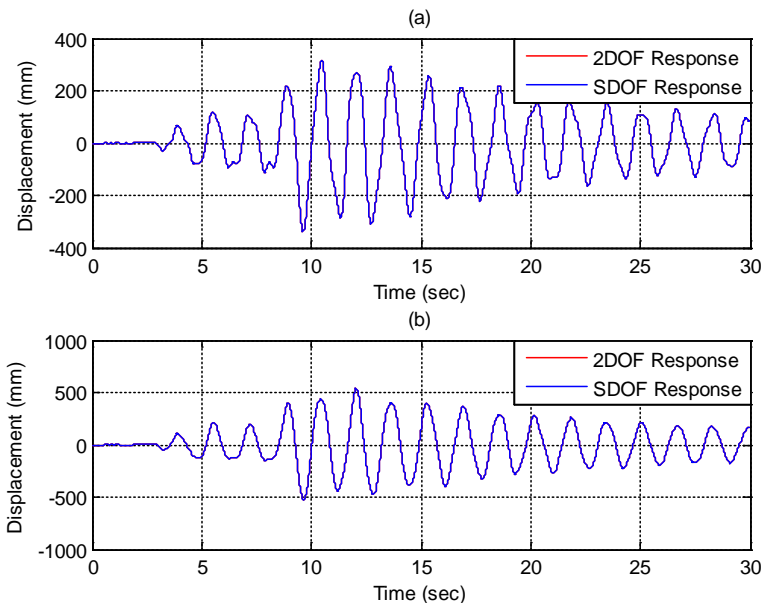

Figure 3. Comparison of the 2DOF modal responses with SDOF responses after modal analysis.

Figure (3a) shows the comparison between the first story measured displacement of the 2DOF structure,  $x_{1m}$ , with the equivalent SDOF modal displacement,  $x_{1q}$ . Figure (3b) shows the comparison between the second story measured displacement of the 2DOF structure,  $x_{2m}$ , with the equivalent SDOF modal displacement,  $x_{2q}$ . The very low error between these measured displacements means that the 2DOF structure was successfully decomposed into two separate SDOF structures and that this method can be used to simplify the analysis of time-delayed linear elastic MDOF structures in RTHS.

### Computational Simulation for Non-linear MDOF Structure

Similar computational analysis is also conducted for a non-linear 2DOF structure. The non-linear structural behavior in this study is simulated using the Bouc-Wen model, in which the non-linear restoring force and evolutionary variable are computed. Figure 4 shows the comparison of the story displacements with and without the incorporation of actuator delay. The ground motion used in this simulation is the 1994 Northridge earthquake recorded by USC in Beverly Hills with a peak ground acceleration of 0.4158 g. The delay incorporated is 3 ms at the first story and 3 ms at the second story. The structure has the natural frequencies of 3.88 rad/s and 10.17 rad/s. The structure is assumed to have Rayleigh viscous damping of 2% for both the first and second story.

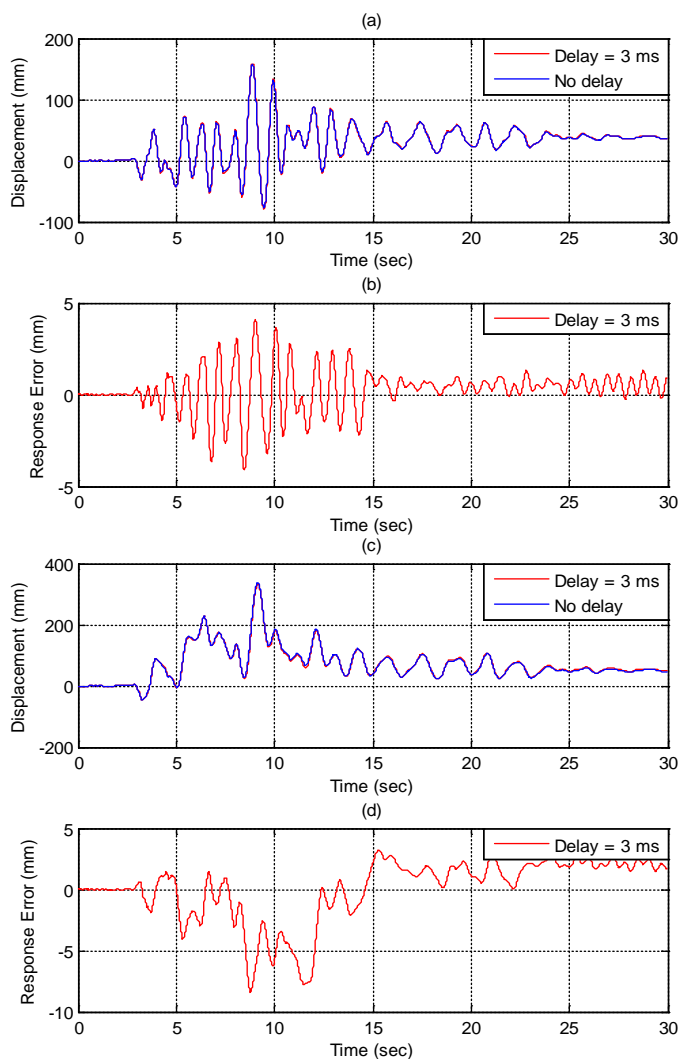

Figure 4. Effect of actuator delay on non-linear structure in RTHS.

Figure 4a and Figure 4c represent the command vs. measured displacement at the first and second story, respectively; and Figure 4b and Figure 4d represent the displacement response error at the first and second story, respectively. The maximum displacement error is 2.6% for the first story and 2.5% for the second story. These errors observed are lower in comparison to the linear elastic structure simulation because the parameters of the Bouc-Wen model control the shape of the hysteretic loop at each mode of the 2DOF structure<sup>6</sup>. Modal analysis of a non-linear structure is not possible because modal decomposition depends on the mode shapes, which utilizes the linear elastic stiffness matrix.

### Integration with Senior Design Project at SFSU

As stated in a 2010 report by the Committee to Assess the Capacity of the U.S. Engineering Research Enterprise [7], engaging students in engineering research is essential for our nation's competitiveness and long-term productivity in a global, knowledge-driven economy. SFSU is one of the 23 campuses of the California State University system and one of the nation's most ethnically and culturally diverse master's-granting universities. With a total enrollment of 29,718

in Fall 2010, SFSU is the 51<sup>st</sup> largest university in the country [8] and ranks 14<sup>th</sup> in the nation in awarding undergraduate degrees to minorities [9]. Of the 29,718 enrolled students, who reported their ethnicity in Fall 2010, 37.2% were from underrepresented minority (URM) groups including 21.5% Latino; 5.9 % African American; 0.8 % Pacific Islander and 0.4% Native Americans. The students in the School of Engineering are equally ethnically, culturally, academically and economically diverse. About 15% of the School's students are women and 78% are students of color (33% Asian, 20% Filipinos and Pacific Islanders, 16% Hispanic, 8% Black, and 1% Native Americans). This diversity is also mirrored by the students in civil engineering program and in the PI's research group. Of the research group in the *Structural Laboratory for Hazard Mitigation* established by PI Chen at the School of Engineering, 50% are underrepresented female and/or minority students. By serving as research advisor and mentor to a diverse research group, the research presented herein therefore encourages a broad spectrum of students to become future leaders in academia and industry, and promotes the importance of diversity in the engineering workforce.

This research was integrated with Senior Design Project at San Francisco State University (SFSU). The undergraduate student researcher was also enrolled in a Mechanical and Structural Vibrations course in concurrence with the research and Senior Design Project. Fundamental concepts covered in the vibrations course such as solving for equations of motion, natural frequencies, mode shapes and utilizing modal analysis to decompose a MDOF structure were directly applicable to the research. The student researcher used these methods to successfully model and decompose a MDOF structure in the Matlab and Simulink programs. The more theoretical concepts such as hydraulic time delay, non-linear structure behavior, frequency domain analysis and programming methods are beyond the scope of the vibrations course and were introduced through the weekly meetings with the advisor. Introducing these concepts has provided a solid foundation and has helped prepare the student researcher for the courses that will be encountered in a structural and earthquake engineering graduate program and for real engineering problems that will be encountered in highly seismic-prone areas.

The Senior Design Project at SFSU is intended to prepare students to deal with real practical engineering problems; which tend to be far more complex than problems encountered in typical engineering courses. The schedule for the Senior Design Project consisted of weekly meetings in which the advisor assigned the student researcher to weekly tasks. These tasks consisted of programming in Matlab/Simulink, performing simulations, and gathering and interpreting numerical data. Weekly logs were to be kept in which the work, results and future plans were summarized. The student researcher was required to submit a brief project proposal for approval outlining the description of the project and the approach to be taken. A more detailed proposal was presented later in which the description, methodology, approach, constraints, tasks and tentative schedule of the project were outlined. The purpose of the proposal was to ensure that the student researcher remained organized and maintained the requirements of the senior design project throughout the course of the semester. The student was required to submit written and oral presentations describing the project; in which the weekly logs were intended to provide aid. Presenting the research in a form of a written report was very similar to a thesis that would be encountered in a graduate program. Presenting the research in the oral presentation enabled the students to develop their public speaking skills. The objective was to prepare students for the written and oral presentations that are regularly encountered in graduate school and professional

practice. The student researcher was also responsible for attending three professional seminars, two business meetings and exercises involving ethical decision making in professional practice. The professional seminars provided insight to the current trends in civil engineering research and design. The business meetings helped the student build a network by establishing early relationships with professional engineers and with companies that are more geared towards the topics in which the student is interested. All of these requirements have helped the student recognize importance of punctuality, participation, communication skills and teamwork in professional practice. Application of this research to the Senior Design Project has enabled the student researcher to develop proficiency in defining, organizing, performing, and reporting the solution to real engineering problems.

### Summary and Conclusions

Real-time hybrid simulation is an efficient technique used to analyze a structures response when subjected to earthquake accelerations. Hydraulic-actuator delay during simulation can lead to inaccurate and unreliable test results. Adaptive compensation of actuator delay is complex for a MDOF structure due to multiple mode participation. Modal analysis allows researchers to convert MDOF structures into equivalent SDOF structures in order to simplify the reliability assessment analysis of time-delay MDOF structures in RTHS testing. This research prepares the student researcher for an advanced degree and career in Structural and Earthquake Engineering. Incorporating research with the Senior Design Project helps the student researcher develop solutions to real engineering problems.

### Acknowledgement

This research is supported by the National Science Foundation under the award number CMMI1227962. The authors would also like to acknowledge support from San Francisco State University ORSP Grant SP692. Any opinions, findings, conclusions and recommendations expressed in this paper are those of the author and do not necessarily reflect those of the sponsors.

### References

1. Chen, C., et al. (2009). "Real-time hybrid testing using the unconditionally stable explicit CR integration algorithm." *Earthquake Engineering & Structural Dynamics*, 38(1): 23-44.
2. Darby, A.P, et al. (1999). "Real-Time Substructure Tests using Hydraulic Actuator." *Journal of Engineering Mechanics*, 125(10): 1133-1139.
3. Chen, C. and Ricles, J.M. (2012). "Large-scale real time hybrid simulation involving multiple experimental substructures and adaptive actuator delay compensation." *Earthquake Engineering & Structural Dynamics*, 41(3): 549-569.
4. Craig, R.R and Kurdila, A.J. (2006). "*Fundamentals of Structural Dynamics 2nd Edition*. Hoboken, New Jersey: John Wiley and Sons.
5. Guo, T., Chen, C. and Xu, W. (2013). "A frequency response analysis approach for quantitative assessment of actuator tracking for real-time hybrid simulation". *Smart Materials and Structure*, under review.
6. Bonelli, A. and Bursi, O.S. (2004). "Generalized- $\alpha$  methods for seismic structural testing." *Earthquake Engineering & Structural Dynamics* 33(10): 1067-1102.
7. Engineering Research and America's Future: Meeting the Challenges of a Global Economy. 2005. Committee to Assess the Capacity of the U.S. Engineering Research Enterprise, National Academy of Engineering of the National Academies, The National Academies Press, Washington, D.C.
8. Chronicle of Higher Education, Almanac Edition. 2011. Campuses with the Largest Enrollments. , last accessed 01/10/2012.
9. Diverse Issues in Higher Education. 2011. Top 100 undergraduate degree producers. last accessed 01/14/2012.

## An Assessment of ABET's Assessment Process

Sukhmander Singh  
Santa Clara University

### Abstract

In the U.S.A., accreditation of engineering schools by ABET has for years been centered on the assessment of the program of the studies and the educational objectives. Much has been written on the methodology for assessment. The emphasis has been on what can be measured. However, some of the most important aspects of education for example, creativity and innovative thinking, which cannot be measured, have been ignored. Enormous amounts of effort in the collection of assessment data and the proportionately small benefits have often frustrated the faculty. The process seems to force teaching to overload and dull the minds of the students rather than to develop them. The heart of education is to develop an ability to think. The process of assessment seems not to place much importance on this aspect of education. Since there is always room for subjectivity on the part of the evaluator, the process is far from being perfect or flawless. At times, subjectivity of an evaluator can cause much extra work, which in the eyes of another evaluator is otherwise fine. Also, why ABET's requirements should be so much more extensive than the licensing requirements. The paper elaborates on these issues, presents examples and suggests remedies to make the process more effective as well as useful.

### Introduction

The assessment program for ABET EC2000 has been in use for a number of years. From the beginning, this has been a difficult, time consuming, and a matter of discomfort for the faculty. Much has been written about the development of program educational objectives, program outcomes and the assessment tools<sup>2 3 4 5 7 10</sup>. The purpose of this paper is not to discuss the process of establishing an assessment program but to focus on the effectiveness of the assessment program in light of the experience of going through the four ABET visits at the author's university. Both the advantages and shortcomings are critically examined.

### Advantages of Assessment Program

One of the most significant aspects of the ABET EC2000 assessment program is that it has come out of the so called 'bean counting' mode of accreditation process, which was based on counting credit hours, design units, etc. Instead it is now based on what students have learnt and what can they demonstrate in terms of the performance and work they can do. Accordingly, this has encouraged interaction between industry and the faculty. For example, program educational objects are set through an effective participation by faculty and industry. Assessment on what the graduates have been performing requires help of industry. Thus, an ongoing communication between industry and the faculty is a definite pro for the assessment program. Engineering schools are now communicating more regularly with the constituencies that their graduates are supposed to serve. As noted above, interaction among industry and faculty together with the feedback process required by the ABET EC2000 assures both balance and quality in education. In summary, an ongoing assessment program, if properly implemented, can be a step in the right direction to improve the quality of education.

### **Concerns and Suggestions**

*General.* It has not been easy to fully grasp certain aspects of the evaluation criteria especially a clear definition of an educational objective and the criterion 3. In addition, the significant amount of time and effort required to implement the process has led to an overload on the faculty resulting in the taking away of quality time. A survey was conducted to find faculty's response to the amount of work load required to ABET's assessment process. About seventy five percent of the faculty were the opinion that it does impose extra time demand, at times excessive due to the following up of industry survey for example. It has also been observed based on author's experience over four evaluations that documentation has become increasingly excessive, a typical of the bureaucratic system.

*On creative and innovative thinking.* Since it has not been easy to develop assessment instruments to measure aspects that are abstract in nature, there has been a tendency to establish program educational objectives and program outcomes that can be measured. The focus of this has taken away from some of the important aspects of education such as creativity and innovative thinking, which cannot be easily measured. Not each faculty is as enthusiastic in restricting their teaching to measurable topics only. The faculty would like to challenge and inspire students to critical and innovative thinking. Is it not the heart of education to develop an ability to think? The process of assessment seems not to place much importance to this aspect of education. An interactive approach<sup>8</sup> that focuses on engaging students can be used for the development of these skills. According to the interactive approach, students are challenged to go beyond the fundamental of a course and develop a topic or issue during specially assigned class periods called "Interactive Periods". The process of probing, through questions and answers, forces students to think creatively. This will be possible if less time is spent on 'awareness skills', as noted further in a subsequent paragraph.

*On subjectivity in the evaluation process.* No matter how carefully the program objectives have been drawn, it has been the author's experience that they are subject to personal interpretation or personal judgement. In the beginning, quite a lot of time was consumed especially in the wording of the educational objectives so that they are aligned with the wordings and terminology recommended by ABET. This is to minimize confusion in the interpretation of ABET's program. There is also a room for subjectivity on the part of the evaluator. It has yet to be tested as to how differently two evaluators would evaluate the same program. The author recognizes the need for further research on this aspect. This should help minimize the room for subjective interpretation of Program Educational Objectives by the evaluators and the program of host institution. The author's experience on such subjectivity by an evaluator has been painful because it was not only very discouraging but required much extra work, thus, taking away quality time from the faculty. Program Educational Objectives (PEO) were acceptable in 2004 but were not acceptable in 2010. We were conscientious of the need for periodic revisions of PEO and had determined that no revision/changes were warranted for 2010. This is not to reflect upon evaluators' capability but to point out that because of the lack of set standards for evaluations, an evaluator cannot escape subjectivity.

*On employer survey and advisory board.* Often, it has not been easy to make industry take enthusiastic participation in the assessment instrument such as an employer survey. Very few



professors engaged in research would like to be an evaluator or an active participant in the assessment program. With regards to the employers' survey, there seems to be no standard check as to how representative the survey is. It is not only the numbers of responses that are important but also how well the different sub-disciplines of a discipline in engineering have been represented by the participating employers. A balanced representation of employers should make the survey more meaningful. A survey by EBI (Education Benchmark Incorporated) is very common, and a large number of universities use it for employers and alumni surveys. But there is no check on the representativeness of the data. Similarly, an advisory board may or may not be a representative body. In this era of multitasking and information overload when everybody is too busy, it is not easy to involve a representative cross section of people in the advisory board. Often retirees are the more willing members of an advisory board. There is a need to seek out and broaden involvement of active personnel from industry. Although ABET requires the program to decide themselves in the selection of 'advisory board' and in the drafting of 'employer survey', it is rarely checked, and there are no guidelines for ABET to check if the feedback from the survey or the advisory board is representative of all the sub-disciplines of a major discipline in engineering.

Given the limitation noted above, the formulation of educational objectives through involvement of constituents and the gathering of assessment data from employers may fall short of their intended purposes. Confidence in assessment finding can be improved by minimizing those limitations. This would require careful formulation of the survey assessment tools. Analysis of the data gathered and the feedback for improvement of the program should be based on the data that is first checked for its representativeness before an analysis is undertaken.

*On technical versus awareness skills.* Per Criteria 3 of EC2000 there are eleven students learning attributes. There is no mention of any relative importance each carry. For example, attributes a–e and k relate to the heart of engineering in which students should be well-grounded, and should, in the author's opinion, carry a lot more importance in determining the ability of students to perform as real engineers. Although the other attributes, which focus on professional and awareness skills (attributes f to j), are important, the quality time that they should, in the author's opinion, take away from teaching real engineering needs to be investigated. This is because the incorporation of these into the curriculum and the difficulties in the development of assessment tools to these attributes have often been a matter of discomfort in the early stages of the assessment process. As the assessment process matures with time, it becomes easier. However, there is a need to assign lesser importance to the awareness skills. This way the assessment process can be more efficient by spending relatively less time on assessment of the awareness skill. There also remains a potential for subjectivity in interpretation of these attributes and in the development of their assessment tools, which can be a source of poor deficiencies/weaknesses. As also noted by Koehn<sup>9</sup>, the practitioners believe that the same level of significance should not be stressed on the awareness issue in an engineering curriculum.

It may be noted that licensing requirements are solely based on technical competency except that State of California requires a take home exam on ethics. However, ABET's requirements are much more extensive. Granted that an engineer ought to be aware of global issues, societal concerns, ethics and other issues per ABET's f to j of Criteria 3, but these should not be done at the cost of technical competency. This is not to downgrade the non-technical requirements but to

suggest that ABET should reassess its requirements in the light of the desire to incorporate advances in engineering over the last 3-4 decades in the bachelor's degree program which remains confined to 4 years, and as pointed out by Shuman, et al.<sup>7</sup>, the students' complaints against the heavy coursework loads.

*On consistency in evaluation.* Although it is believed that before one becomes an evaluator, one has to participate as an observer on a typical evaluation visit, yet it has been noticed that some evaluators have never had the experience of being an observer. Some societies, in their training program for evaluators, do not require them to be observers first. Also, there is a need to have a particular program evaluated by two different evaluators to see if there are in any weaknesses in the training programs to determine if the element of subjectivity can impact the final results. The ABET Industry Advisory Council's efforts on quality control are to be published for the purposes of refining the assessment program and encourage greater participation by the engineering faculty especially for continuous improvement on an ongoing basis rather than a year before evaluation time.

### Conclusions

1. ABET Assessment process has demonstrated accomplishment in improving the quality of education, yet some important attributes of education such as the creativity and the development of an ability to think have not been given due attention they deserve.
2. In the assessment process, regarding employer survey, there should be a way to check if the data collected is representative of all the areas across a discipline in engineering.
3. There is a need to assign a level of importance to the five Engineering Skills based attributes (a, b, c, e and k) with respect to the other professional skill based attributes (f – j) to help budget the time and efforts to achieve balance.

### Acknowledgments

Kalen Cornelious and Paige Rogalski's help in preparing this paper is gratefully acknowledged.

### Bibliography

1. Joint Task Force on Engineering Education Assessment, "A framework for the assessment of engineering education," ASEE PRISM, May-June 1996, 19-24.
2. Shaeiwitz, J.A. (1996). "Outcome assessment in engineering education," *Journal of Engineering Education*, 239-246.
3. Olds, B.M., & Miller, R.L. (1998). "An assessment matrix for evaluating engineering programs," *Journal of Engineering Education*, 87(2), 173-178.
4. Rogers, G., & Sando, J.K., 'Stepping ahead : An assessment plan development.
5. Prados, J.W., Editor's Page, *Journal of Engineering Education*, 86(2) (1997), 70-71.
6. Prados, John W. (2004). "Can ABET really make a difference," *International Journal of Engineering Education*, 20(3), 315-317.
7. Shuman, L.J., Besterfield-Sacre, & McGourty, J. (2005). "The ABET Professional Skills" Can They Be Taught ? Can They Be Assessed" ; *Journal of Engineering Education*, 41-55.
8. Singh, S., (2003). "An Interactive Approach to Improve Civil Engineering Education," *Proceedings of the 32<sup>nd</sup> Symposium of IGIP's Annual Conference*, 335-337.
9. Koehn, E., (1997). "Engineering Perceptions of ABET Accreditation Criteria," *Journal of Professional Issues in Engineering Education and Practice*.
10. Morgan, J., & Barroso, L. R. (2006). "Project Enhanced Learning in Structural Analysis," *Proc., 9th Int. Conf. on Engineering Education (ICEE) CD-ROM*, University of Puerto Rico, Mayaguez, PR.

## **Computer Application Blended Course Redesign: Lessons Learned and Impact on Student Success**

Edward Smaglik, Terry Baxter, John Tingerthal, Chun-Hsing Ho, and Mark Lamer  
Northern Arizona University

### **Abstract**

Over the past few years many universities have experienced increasing student enrollments while the faculty and classroom resources have remained unchanged. The blended classroom has become a strategy that is being promoted to accommodate what has become a resource imbalance. Two freshman-level required courses, Computer Aided Drafting in a Civil and Environmental Engineering program and Computer Applications in Construction in a Construction Management program, have recently been redesigned as blended courses, to address these resource constraints as well as challenges caused by changing student demographics. The blended delivery course format was chosen because it has the potential to more effectively utilize classroom space and can allow students to learn material at their own pace. These two courses provide students with rudimentary computing skills using software applications that are germane to their respective fields. Given that some of the topics of the two courses overlap, a team of five faculty members from both programs collaborated to redesign the two courses for delivery in the fall of 2013. One of these courses was scheduled to meet twice weekly for a total of 200 minutes, while the other met three times weekly for a total of 150 minutes. The blended course redesign effort included revising the weekly schedule so that it now consists of 75 minutes for faculty-led lecture that is then succeeded by an optional 75 minute session facilitated by a student lab aide. The lecture is preceded by the students completing tutorials, practice assignments and an assessment within an on-line learning center that intends to prepare them for the module topic before they attend the lecture. This paper discusses the details that led to the decision to redesign these courses, and describes the various issues that have been encountered during the inaugural delivery of these courses. The course modifications will then be assessed by reviewing the grades of the students submissions received over the duration of the current semester and analyzing the change in grade distribution when correlated to previous course offerings. The student submissions for the current course offering to be evaluated have remained largely the same as the previous course offerings, with the only modifications being the addition of the materials provided in the online learning center. Lastly, changes implemented for the current semester based upon lessons learned in the inaugural semester will be presented, along with long term guidance for the successful delivery of these courses.

### **Introduction**

Between 1996 and 2010 enrollment at post-secondary institutions increased by 46 percent and it is projected to increase by an additional 15 percent by 2021, resulting in larger demands on faculty and other resources<sup>1</sup>. This resource imbalance presents the opportunity to explore alternative approaches to course delivery with the aim to simultaneously improve the student learning experience while more efficiently utilizing classroom space and faculty time. One promising method for doing this is to move the acquisition of content knowledge out of the classroom, leaving classroom time for the assimilation of that knowledge<sup>2</sup>. This is known as the ‘inverted’<sup>3</sup> or ‘flipped’<sup>4</sup> classroom that relies on ‘blended learning’<sup>5,6</sup> techniques. Such methods have been historically called ‘hybrid courses’ when online learning management systems (LMS)

are utilized to complement the face-to-face (FTF) classes. Two introductory computer courses in the Department of Civil Engineering, Construction Management and Environmental Engineering at Northern Arizona University were redesigned prior to the fall 2013 semester to capitalize on the benefits of blended learning techniques. The redesigns were motivated by a number of factors including a high demand for a single computer teaching lab, a decrease in student performance, an increase in the number of students for which English is a second language (ESL), a desire to better utilize faculty time, and a desire to improve the quality of the learning experience. With support from the university's Provost Office and e-Learning Center, five faculty members embarked on a curriculum redesign to address these factors. This paper summarizes the history and development of the blended approach to these two courses and discusses some preliminary results. After one semester of implementation, we found that student performance did not improve or degrade significantly and that the redesign required a great deal of effort to put into place. Now in its second semester, the faculty have implemented some changes based on observations detailed in this paper and are now beginning to experience benefits of the redesign, including a decreased effort delivering the courses.

### **Background**

The two classes involved with this redesign are both entry-level computer-based classes, serving approximately 180 students per year. The titles of these courses are CM130: Computing in Construction and CENE180: Computer Aided Drafting (CAD). The curriculum in each course differs in that the Computer Aided Drafting course is required for all civil and environmental engineering students and focuses entirely on AutoCAD, Civil3D and Revit, while Computing in Construction is a required course for students in the Construction Management program that introduces students to a variety of software applications used in construction project management, including AutoCAD, Revit, MS Project, On-Screen Takeoff, and MS Excel. Although the content of these courses is different, the many similarities made them prime candidates for parallel treatment when redesigning: Both courses focus on learning to use complicated professional software, both were taught using a combined lecture-lab format, both use the same computer classroom and both were originally developed by the same faculty member.

Both of these courses have long been 'enhanced' by the use of the university LMS (BbLearn and Vista) to deliver content, manage assignments and track student progress. The classes met in a classroom that is dedicated to computer instruction, being equipped with thirty-three dual-screen PC workstations that are updated on a two to three year cycle. New topics in the classes were typically introduced every one to two weeks via a traditional lecture in which the instructor walks the students through the rudimentary steps required to complete a particular task. Each topic concluded with a lab assignment aimed at providing the students with practice and providing instructors with a way to assess if students are meeting intended learning outcomes. Class time during the balance of the week was allocated to guided work sessions in which the instructor and a peer TA helped students work through the assignments. Thus, the courses followed the time-honored approach of delivering content to student followed by an immediate expectation for them to assimilate the processes and content through assigned work.

Students bring to these classes a wide spectrum of computer skills. For instance, some computer aided drafting (CAD) students have had CAD classes in high school, while other students are complete technophobes. The original structure of the courses required everyone to sit through the

same basic instruction which was designed for the majority of the students. Unfortunately, we have found that this leaves the savvy student bored and resentful, while the challenged student can easily fall behind. In the past few years, the number of students for whom English is a second language tended to fall into this latter group. Overall student performance in these courses has been degrading over time, while scheduling demands on the computer classroom (which is shared by four different programs) has steadily increased. In addition, while content pertaining to additional software (Revit, Civil 3D) had been added since the course was originally developed, some of the assignments that were developed in 2006 had become rather stale, suggesting a need for updating.

In 2012, university administrators announced a Blended Learning Initiative<sup>7</sup>, offering support for faculty to redesign courses using a blended approach. Motivated in part by this initiative and reports on successful course redesigns<sup>8</sup>, the current course instructors met with the faculty member who originally designed the curricula to draft a proposal to redesign these courses. Drawing on the original instructor's experience with blended courses<sup>9,10</sup>, the team identified potential advantages of a blended approach and settled on the following project objectives:

1. Improve the student-centered learning environment in these courses so that it aligns with the various learning needs and styles of students both in and out of the classroom
2. Increase the efficiency and effectiveness of our faculty who are teaching these courses
3. Increase the efficiency with which we utilize computer lab resources

### **Description of the Redesign**

With these objectives in mind, the team started by looking holistically at both courses and evaluated each topic against course and program outcomes. The choice to use the online LMS (BbLearn) to blend these courses was natural, since the very nature of the courses was centered on computer usage. Blended learning, which in its simplest form “is the thoughtful integration of classroom face-to-face learning experiences with online learning experiences,”<sup>11(p96)</sup> leverages the online environment to improve the student learning experience. Uzun<sup>12</sup>, for instance, reports that blending can make a difference in a computer literacy course, but cautions that it is the instructional use of technology and not the technology itself that should be the focus. ‘Flipping’ is a method of blending that moves the delivery and transfer of information out of the classroom, allowing students to engage with the content at their own pace prior to class. In a flipped classroom, the difficult part of education, the assimilation of that information, then becomes the focus of the face-to-face class. Eric Mazur<sup>2</sup> suggests that the problem of the traditional lecture approach to education is that there is too much focus on transfer of knowledge in the classroom, and students are left on their own to try to assimilate this information into a usable form.

With the framework of the flipped classroom as a model, and using an online blended approach, we then crafted a course structure that would best work for these classes. To most effectively utilize the faculty member's time and to allow for more flexible student assistance, we designated one class period each week as instructor-led and the second as an optional TA-led lab. Because of the multiple sections, we scheduled these lab sessions so that students from any one section could attend more than one lab session, thus providing additional resources to those who needed it. Following the flipped model, we front-loaded the delivery of basic information for each topic into an online environment, requiring that students complete it prior to the instructor-led session. We generally relied upon available video tutorials and instructor-created slide shows for content

delivery.

However, to be effective, one cannot just place material online and expect any more success than one would expect by directing students to just “read the textbook”. Effective flipping means planning the class with good practice in mind. In their seminal work on teaching and learning, Chickering and Gamson<sup>13</sup> proposed that good teaching practice: encourages contact between students and faculty, develops reciprocity and co-operation among students, encourages active learning, gives prompt feedback, emphasizes time on task and communicates high expectations. The first of these are embodied in the face-to-face sessions. To stimulate active learning and motivate students to spend time on task, we developed online modules that required the students to complete practice assignments based on the content. Prompt feedback is provided by the way of automatically graded assessments embedded within each module. Instructor -graded assignments for each module then challenge the students to meet the high expectations of the course.

The resulting curricula shifted much of the responsibility for learning to the students and attempted to utilize both faculty time and facility resources more effectively. The nature of the online resources for basic content delivery (e.g. video description of the steps necessary to precisely draw a shape in AutoCAD) has many advantages: Students can interact with them multiple times, stopping and starting as need be; students can work through the tutorials at their own paces, and closed-captioning on videos provides additional help for students for whom English is a second language. Students who do not require extensive guidance can move quickly through the basic content and can then focus on more difficult tasks.

## **Results and Discussion**

The courses were redesigned during the summer of 2013 and the inaugural deployment using the blended format occurred in the fall 2013 semester. In order to aid in the appraisal of the efficacy of the blended course versus the previous offerings, several course assessments used in each course prior to the redesign remained unchanged. In the forthcoming sections of the paper, statistical comparisons of these data based on this first semester of implementation will be presented along with some qualitative observations.

*CENE 180: Computer Aided Drafting.* In this course, three indicative assignments (Scale Lab, Border Template and Final Project) were selected a priori to remain unchanged in order to assess whether any differences in student performance result from the course redesign. The overall course scores were also identified as indicators of student performance. It would not be unexpected to experience a reduction in student performance during the first semester of implementing any course redesign, simply because of unintended difficulties that can arise with any major course change. The desired expectation for this first semester was that there would be, at least, no difference between student scores before and after the redesign, with the expectation that student performance would improve over time.

The data available to assess differences in student scores spans four semesters prior to the redesign and one semester after the redesign. All score values were normalized to be expressed as proportions (e.g., a score of 15.5 points out of 20 = 0.775). Proportion data can typically be normalized by using the arcsine transformation and the removal of outliers, however these data were found to lack independence even after the distribution was normalized and thus the usual F-

test of significance (ANOVA) was considered invalid. The Wilcoxon two-sample test, a distribution-free method, however, allows the differences between the scores before and after the redesign to be analyzed. The results from analyzing these initial score data are summarized in Error! Reference source not found., comparing selected CENE 180 scores before and after the course was designed for blended delivery ( $H_0$ : scores from before and after the blended course redesign come from the same population).

Prior to the discussion of the statistical comparisons, it should be noted that these data should be considered with some caution because there has only been one semester completed since the redesign has been implemented. That said, the comparison between assignment scores after one semester of implementation are somewhat mixed when considering the assignments. Out of the three assignments used for this assessment the Scale Lab shows no significant difference ( $p=0.7$ ) between before and after scores, a second (Border Template) shows a significant difference ( $p=0.006$ ) in that the scores after the redesign were slightly lower, and the Final Project show a highly significant difference ( $p<0.001$ ) in that the scores after the redesign were higher. The first two assignments (the Scale Lab and the Border Template), were delivered in identical fashion as in previous semesters. The third assignment, the Final Project, was delivered in a staged manner with interim deliverables, providing students with graded feedback on submitted work prior to the submittal of the entire project. In prior semesters, there was an optional submittal available for students to receive this feedback, only the final submittal was required. Perhaps a somewhat more representative analysis at this early stage is possible by considering the comparison results in Error! Reference source not found. for the Course Total scores in which student performance was not significantly reduced ( $p=0.08$ ), as was minimally desired for the inaugural semester.

One additional item to consider when viewing the analysis of these scores is their trend versus the percentage of students with English as a second language (International or “ESL Students”) in the class. The enrollment of these students has increased substantially during the four-semester period leading up to the redesign, accounting for almost 50 percent of the class. Figure 1 presents the overall trend for the average assignment scores and the final course scores, along with the trend of ESL student enrollment in the CENE 180 course.

Table 1. Summary of Wilcoxon test for CENE 180.

Selected Scores Evaluated	Mean Score Before	Mean Score After	Significance of Difference
Scale Lab	0.894 (n = 110)	0.897 (n = 75)	Difference is not significant (p = 0.7)
Border Template	0.780 (n = 103)	0.753 (n = 68)	Difference is significant (p = 0.006)
Final Project	0.760 (n = 100)	0.855 (n = 80)	Difference is significant (p < 0.001)
Course Total	0.803 (n = 107)	0.768 (n = 87)	Difference is not significant (p = 0.08)

In general, prior to the implementation of the blended course redesign, scores decreased as ESL student enrollments increased, with the exception being the final project. Since the final project

should be a better measure of what the student has been able to learn throughout the semester, the language difficulties that ESL students might have had earlier in the semester may be expected to be diminished by the end of the semester and thus have less influence on that score. Both the scale lab and the border template assignments occur earlier in the semester when language difficulties may have a larger influence on scores.

The overall course score, as would be expected, also reflects this influence since it is an aggregate of scores throughout the entire semester. It should be noted however, that even though the ESL enrollment continues to increase, the average scores during the first semester of implementation actually tended to be better. Even the final project demonstrated a slight increasing trend in scores. One other interesting item in Figure 1 is the see-saw motion of the Final Project scores between the fall and spring semesters. Anecdotaly, the instructors have noted that students in the spring semester of this course tend to perform stronger than those in the fall semester, likely due to the fact that most of the fall semester students are first semester freshmen, undergoing all of the transitional processes that occur when students embark upon their college career. Students in the spring semester have already made it through the critical first semester, and have that experience to draw upon when addressing the demands of the course. This plot seems to corroborate the experiences of the instructors.

Finally, the influence of attending the open lab on students' scores was also assessed. The course score data from all 3 sections of CENE 180 during the first semester of this implementation were compared against the number of times a student attended the optional lab session. Although there appears to be a slight tendency for scores to increase with lab attendance, as can be seen from Figure 2, the overall influence of attending lab sessions on improving course scores was actually quite low, with  $r^2$  values of 0.126, 0.052 and 0.078 for the three sections, respectively. This may indicate a need for making the assessments more challenging, as many students did not need the lab section to perform well in the course.

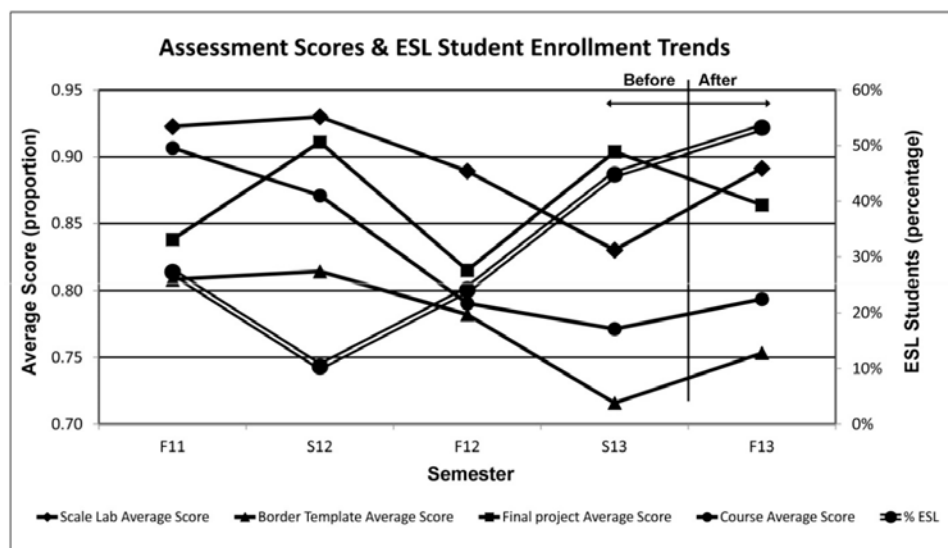

Figure 1. Average scores and ESL student trends.



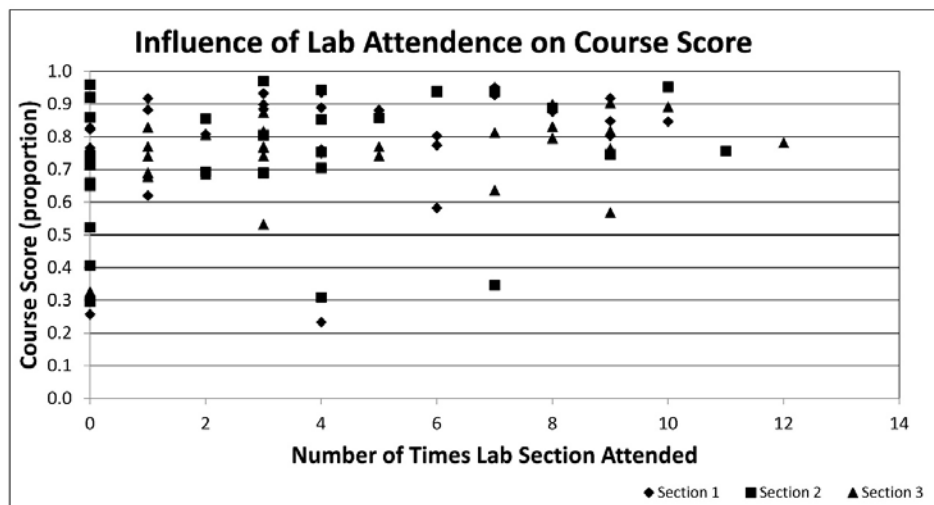

Figure 2. Influence of lab attendance on course score.

Qualitatively, the reaction of the instructional staff was mixed regarding the impact of the redesigned course. One challenge that had to be overcome was brought about by the university schedule. One section was offered on Monday, with lab convened later the same day, and the other two sections met on Wednesday. Since the university started and finished its calendar on a Wednesday, and observed two Monday holidays (Labor Day and Veterans Day), the Wednesday sections met 16 times during the semester, while the Monday section only met 13 times and missed the critical first week meeting because of a holiday. We believe that this did have an impact on the performance of the Monday section versus the Wednesday sections, even though the course scores were not significantly different (see Table 2).

Table 2. CENE180 section comparison.

Comparison of Sections by Instructor	Mean Score	Mean Score	Significance of Difference
	Monday Instructor	Wednesday Instructor	
Fall 13 Sections	0.752 (n=28)	0.769 (n = 59)	Difference is not significant (p = 0.13)

Certain issues arose with the online assessments that were due prior to the class. The online quizzes were designed to be formative such that if the students incorrectly answered a question, the feedback they received would point them in the direction of the correct response. They were allowed to take the quiz twice, and receive the higher of the two grades, with the intent that they would return to the online material to search out the correct response. While this likely worked with the few students who worked independently, many of the students appeared to collude with each other when completing the quizzes, resulting in a grade book full of perfect quiz scores. When asked, directly in class, a question identical to that presented on the quiz, some students with high quiz scores were unable to even understand the question.

In addition, the first few weeks of the semester were quite rough due to the unavailability of some of the materials developed specifically for this course. The instructional staff worked with the e-Learning center to develop a number of tutorial videos (eight total) on technical drawing and

orthographic projection. Unfortunately, the tutorials were not completed in time, requiring the team to substitute inferior videos at the last minute.

Lastly, regarding faculty time savings, one of the original goals of this redesign was to use faculty time more effectively. Previously, the faculty member spent 200 minutes per week in the classroom, a value reduced to 75 minutes with the redesigned course. While less time was certainly spent in the classroom, any time savings was expended grading and managing the online part of the class. The instructors anticipate that the increased time dedicated to grading will decrease as the assignments are vetted to work better in the LMS. However, with the class schedule adjusted as part of the redesign, the class now fits into the standard schedule. This was not the case before, and does equate to a more efficient use of the facilities.

*CM 130: Computing in Construction.* The CM 130 course had the same issue as the Monday section of CENE 180 due to the University's schedule: Students did not meet until the third week of the semester, and thus had only 13 instructor-led classes. In comparison with time spent prior to the redesign, the schedule restructure utilizing the TA-led lab did increase the efficiency of the faculty instructor.

Three class assessments (Revit project, First exam, and Course Total) were selected a priori to help evaluate the influence of the course redesign on student performance. Using the same analysis method as was used for CENE180 (Wilcoxon test), student performance before and after the redesign was evaluated. Before doing the Revit project, the students had to work through two assignments to gain basic concepts. The first exam was intended to test student's level of understanding on how to effectively use Revit and AutoCAD. Due to the difficult start of the semester, lower performances for both Revit project and the exam score might be expected. With this being the first semester where students were to follow a schedule having one instructor-led session plus one TA-led lab per week, it is hypothesized that the overall student performance would not be significantly better than the previous semester. To evaluate this, data from these three assessments were collected before and after the course redesign. The Wilcoxon test results are shown in Table 3.

Table 3. Summary of Wilcoxon test for CM 130.

Selected Scores Evaluated	Mean Score Before	Mean Score After	Significance of Difference
Revit Project	0.767 (n = 32)	0.814 (n = 24)	Difference is not significant (p = 0.8)
Exam 1	0.860 (n = 35)	0.747 (n = 25)	Difference is significant (p = 0.03)
Course	0.900 (n = 17)	0.791 (n = 29)	Difference is not significant (p = 0.28)

While student performance on the Revit project improved by 4 points after the redesign the influence of redesign on student performance was not significant and the increase of the Revit project score did not correlate to an increase on the first exam. In fact, the mean score of Exam 1 dropped, suggesting a significant difference (p = 0.03) between the two semesters. The reasons for this could have been caused by the University's schedule arrangement in that students were

simply not well prepared this early in the semester. This seemed to be confirmed by observations during the exam revealing that many students struggled with completing the Revit drawing in a short time period. This may imply that students did not gain sufficient knowledge before the exam to prepare these drawings. This could also be attributed to factors such as the reduction in the number of instructor-led lectures, or that students avoided attending lab hours where they could have practiced the assignments. However, this result needs further observation to more fully assess the influence of the redesign on student performance. Due to the limited lecture times (13 weeks), the instructor needed to skip some of the steps during lectures. This resulted in a minor impact on students' final course scores. As shown in Table 3, after the course redesign the mean score of students' final grades for CM 130 dropped by about 10 points, however the Wilcoxon analysis of this difference in student performance was found to be not significant ( $p=0.28$ ). Even though the difference of student performance after the redesign was not significant, this 10-point decrease in student performance suggests that there remains a need to reassess the structure and schedule arrangement of the redesigned course.

Overall, the results of the statistical analysis reflect that there is a need for improvement, something that is corroborated by the instructor's experience. It was observed that many of the students were struggling with getting the assignments/projects done on time. The number of e-mails from students asking for additional instruction increased from previous semesters, particularly when the deadline of an assignment was approaching. Because the lecture and lab met on the same day, there was little opportunity in the schedule for students to solicit assistance from the instructor between class meetings.

To gather feedback from the students the CM 130 instructor administered a student survey at the end of the inaugural semester. The results of this survey showed that 12 percent of the students disagreed or strongly disagreed that the blended instruction could help them better prepare for the assignments/projects. It was noticed that the feedback for the disagreement of the instruction was mainly caused by the class schedule, consistent with the observations mentioned above. Students expressed that putting two lectures on the same day could not allow them to completely practice and ask questions. For example, after Monday's class schedule, the students had to work individually to complete assignments/projects. If students had any questions, they did not have an opportunity to ask for help because there were no more lectures scheduled for the rest of the week. Based on the survey, there is room for restructuring the schedule to better fit the student need and improve their learning experience.

## **Conclusions**

Our original goal of improving the learning environment for these courses was evaluated by looking at student performance in the two courses. While it is desirable for the performance to improve after a redesign, it is not unexpected to actually have performance decrease while bugs are worked out of the system. In general, student performance was no worse after the redesign than before, suggesting that this redesign does have potential. We intend to continue to collect data over the course of the next few semesters in order to better identify a trend. Regarding our goal to increase efficiency of our faculty, we found mixed results. In one course (CENE 180), the in-class time savings was traded for the additional effort required to manage the online environment. In the other course (CM 130), the instructor reported a net time savings. Future plans to add faculty involvement back into the labs (described below) may further degrade any

savings, but as the instructors develop more comfort with the redesigned courses, the effort required would be expected to decrease. The restructure of the class schedules did have a positive effect on the efficient utilization of the facilities. By making these two courses fit within the standard university class schedule, more courses can be offered in the computer classroom. From the long term point of view, the redesign will be expected to promote student self-learning interest and motivation.

### **Future Directions**

Based upon the experiences of fall 2013, changes were made in the delivery of the courses. For both courses, the lab section was moved to another day of the week, providing students the time to assimilate the material covered in the instructor-led class prior to attending TA-led lab. Also, attendance at the lab section is now required, as it was believed that when the lab was optional, the motivated students took advantage of the lab section while the students that really needed to attend the lab, did not. Second, quizzes are now taken at the start of the lecture sections to address the collusion issues experienced during the first deployment of the course (This was not an issue in the CM 130 course, as the quizzes were already taken in class). Third, while the lab section is still led by a lab aide, the instructor is now attending the first 15-30 minutes of each lab section to kick it off. It is believed that the presence of the faculty member lends a bit more authenticity to the lab section, in that students may have previously viewed it akin to a study hall. Additionally, to help students address their concerns after lab hour, an additional TA office hour has been offered on a successive day to allow additional opportunity for assistance.

The videos that were unavailable for the first two weeks of content in the fall 2013 semester became available for the current iteration of the course. Lastly, the instructors are now providing a bit more guidance within the LMS for the students, as in this iteration, they have a bit more time to critically address what is being presented, as opposed to the rushed completion that can accompany the delivery of new material.

Although the staff is only three weeks into the spring 2014 semester at the time of this writing, it is believed that each of these changes is already having a positive impact on the performance of the students. While the data to confirm this belief is purely anecdotal, the students do seem to be more engaged with the class and its format, something that was noticeably absent during the fall semester. This observation works in the direction of our first objective of this project to improve the student learning environment. A longer term consideration is that the staff would like to implement performance testing within the class, such that students must show that they are proficient on specific skill sets at various points during the semester prior to proceeding to subsequent modules. Second, the staff is considering implementing exams in both courses. Given the design nature of the deliverables in this course, historically exams had not been deemed necessary in the CAD course (CENE180). However due to growing academic integrity concerns not addressed in this paper, it is felt that in-class individual exams, such as the ones already used in CM130, may be the only true way to assess knowledge of the student population.

### **Bibliography**

1. Hussar W. J., Bailey T. M. Projections of Education Statistics to 2021 (NCES 2013-008). Washington, DC: U.S. Government Printing Office; 2013. Available at: <http://nces.ed.gov/pubsearch/pubsinfo.asp?pubid=2013008>.
2. Mazur E. Flip the classroom and catalyze the learning. 2012. Available at: <http://www.educause.edu/library/resources/flip-classroom-and-catalyze-learning>.

3. Lage M. J., Platt G. J., Treglia, M. Inverting the classroom: A gateway to creating an inclusive learning environment. *J. Econ. Educ.* 2000;31(1):30.
4. Bergmann J, Sams A. *Flip Your Classroom: Reach every student in every class every day.* Eugene, OR: International Society for Technology in Education; 2012.
5. Caulfield J. *How to Design and Teach a Hybrid Course : Achieving Student-Centered Learning Through Blended Classroom, Online and Experiential Activities.* Sterling, VA: Stylus Publishing, LLC; 2011. Available at: <http://site.ebrary.com/lib/nau/docDetail.action?docID=10546487>.
6. Glazer FS, ed. *Blended Learning.* Sterling, VA: Stylus Publishing, LLC; 2012.
7. *Blended Learning.* 2014. Available at: <http://nau.edu/Blended-Learning/Programs/>.
8. Twigg C. Improving QUALITY and Reducing COST. *Change.* 2003;35(4):22–29.
9. Tingerthal JS. *Applying the Decoding the Disciplines Process to Teaching Structural Mechanics: An Autoethnographic Case Study.* 2013;(May).
10. Rogers T, Tingerthal JS. Blended learning and “flipping” the construction management classroom for improved teaching and learning. In: *ASC Proceedings of the 49th Annual Conference.* San Luis Obispo, CA; 2013.
11. Garrison DR, Kanuka H. Blended learning: Uncovering its transformative potential in higher education. *Internet High. Educ.* 2004;7(2):95–105. Available at: <http://linkinghub.elsevier.com/retrieve/pii/S1096751604000156>. Accessed July 23, 2012.
12. Uzun A. Blending Makes the Difference : Comparison of Blended and Traditional Instruction on Students’ Performance and Attitudes in Computer Literacy. 2010;1(3):196–207. Available at: <http://cedtech.net/articles/13/131.pdf>.
13. Chickering AW, Gamson ZF. Seven principles for good practice in undergraduate education. *Biochem. Educ.* 1987;17(3):140–141. Available at: <http://linkinghub.elsevier.com/retrieve/pii/0307441289900940>.

## **A Graduate/Senior Level Interdisciplinary Medical Technology Design Class**

Tina Smilkstein

California State Polytechnic University, San Luis Obispo

### **Abstract**

This paper is a report on an interdisciplinary graduate/senior level medical technology design class offered through the electrical engineering department at California Polytechnic State University at San Luis Obispo Spring 2013. Participating students were from electrical engineering, biomedical engineering, computer engineering, psychology and computer science. The course had a major project component where student self-formed groups and did a project of interest to all members of the group. Grading of the project was based on a demonstration and report that were due at the end of the quarter. Due to the uniqueness of each project, weekly meetings were set up where the students reported progress and problems. An ongoing Google-Doc document was also created that they were required to update weekly and was graded. Lectures included topics which all majors could participate in such as privacy and security, ethics, discussions of computer systems where humans are considered an element and a more technical section where each major taught the rest of the class something that was related to the course that they were experts on. Grading was largely based on the project but also included class participation and class presentations. The course was well received by the majority of students and there was gratitude expressed from the students for the opportunity to work with students from other disciplines. Projects from the class spawned a product (already in use by CalTrans), multiple Master's projects, multiple senior projects, and a new collaboration between electrical engineering, materials science, biomedical department and a group on campus doing printed circuits in the Graphic Communication department. The course not only gave the students an opportunity to explore how to work with interdisciplinary teams but also a view into other specialties that they might need to seek out to complete projects in the future.

### **Introduction**

Cal Poly implements its "learn by doing" tenet by pairing most lecture classes with a laboratory. Some labs allow the student to verify that a theory that was introduced during the lecture part of the class holds true and some labs are to allow the students to practice design techniques and give them the opportunity to make design decisions. But, due to the tight schedule of an electrical engineering (EE) and computer engineering (CPE) students at Cal Poly, the majority of their labs are limited to EE or CPE topics. Of course we want to make our students expert EE and CPE graduates so stressing EE and CPE topics in lab is a given but since I have arrived at Cal Poly, there has been a growing number of EE and CPE students coming to me and asking about doing medical technology projects. The interest in applying their EE/CPE knowledge to a problem from the medical technology field was of high interest to them (and me) and I looked for a way to provide an opportunity for them to put some time into exploring what their training can be used for in other fields Cal Poly has a biomedical club as well as a diabetes club and I had the opportunity to visit and listen to the students from these two groups discuss projects and interests. There was a common theme that the members of these groups were facing the same issues as the EEs and CPEs: They had knowledge of their specialties and had an interest in

building devices based on their knowledge but their EE/CPE knowledge wasn't in depth enough to actually bring their ideas to fruition. From there it was a small step to come up with the idea for an inter/multi- disciplinary course where the students could share their knowledge in order for both to build something that they couldn't (easily) build on their own.

The course I hijacked was a graduate level course called "Computer Systems". This may not seem an appropriate class to do interdisciplinary projects in but if you look at the newest definitions of a computer system, you'll see that, now, many places consider humans as a component of a computer system. I opened the course up to all majors and ended up with students from EE, CPE, CSC, Biomed and psychology in the class. The fact that it was a graduate class brought more mature students and students that had a clearer idea of what they wanted to do in the future. Due to the time they had already spent in project courses, many of them came with ideas and were truly interested in making their projects work. The interaction between students of different backgrounds all very invested in creating a functioning "product" was a very rewarding sight to see. This report describes the structure and "process" of the course and then gives a self-evaluation of what needs to be changed or improved.

### **Challenges**

The course had a number of challenges including making it available to a population of students with pretty stringent course requirements and not much ability to select courses freely. The course counted for EE and CPE students as a technical elective but was not a credit course for the other majors. There was no way around this barrier except to hope that there were students that were interested in taking courses purely for the knowledge. The result was a body of students that were truly interested and driven to complete their projects. The students from other majors that took this class were outstanding and probably the reason for the success of this class.

There was a financial barrier to some of the projects that was covered partly by the students themselves, partly by me and, in some cases, by partial department support. We were supported by the department technicians and some projects used components from salvage or the back room of the hardware technician. The lab assigned to the class was a digital lab and some of the equipment required for testing of devices was not available in the assigned lab. Cal Poly has open electronics labs so the equipment barrier was overcome by giving the groups that needed access to particular equipment access to those labs. Labs used include the assigned digital lab, the basic electronics labs, the RF lab and a room for testing of the video signal processing project.

I envisioned a time issue. The course was just 10 weeks long and the first few weeks, I assumed, would be dedicated to finding an appropriate project. Thanks again to the quality and diligence of the students that signed up for this class, projects were already being built by the third week of class and all but one of the nine groups had a working prototype in week 10. The knowledge for each project was gathered by the students participating in each project. If I didn't have the information, I or the students would search for references or contact an expert to ask for help. Cal Poly has access to the IEEE journal database which was extremely helpful. I also greatly appreciated the support from professors at UCLA and UCI for their support to the eldercare daily diary health monitoring project and to the Cal Poly professors that gave support on the Glucose sensor project. There were 29 students in the class (plus 3 students just participating in the

projects). Mentoring that many students who are all doing different projects was a challenge and would have been a problem if the students themselves were not as self-starting and if I didn't have the help of professors around the campus and from other schools. Due to the limited number of upper level technical courses, the next time this course is taught, content will have to include the original advanced computer architecture content. I believe in this class project so I am planning on still offering the course to the non-EE/CPE/CSC students but then also have either one separate lecture per week where I split the EEs, CPEs and CSCs from the other students in the course for some number of weeks so I can talk about the required computer architecture topics to the EE, CPE and CSC majors.

### **Course Lecture and Lab Content**

A general schedule of the course is included in Appendix A. Due to the variety of backgrounds in the class, lecture was a challenge. Successful portions of the course included discussions that each major could come at from their own viewpoint. For example, reading on electronic medical records was assigned in the first week. Each student had a role assigned to them and they were told that they would have to argue for their viewpoint in class on week 2. Roles assigned included a drug company representative, a patient going to the emergency room, an insurance company representative, a small practice manager, an HMO, a large hospital and others. The assignment showed the students that for the same information, various meanings can be taken. Subsequently a discussion of systems and designing for a range of users was discussed.

The course's technical content was split between the lab and the lecture but, since there was such a wide variation in knowledge of the students, lectures on technical topics were limited to topics that would be new to all students. The second half of the course had the students that were experts in a topic teach the class for part of a lecture. I believe having the students teach what they are experts in gives them a greater stake in the class, solidifies their knowledge and keeps them from getting bored, but this turned out to be the weakest portion of the class. Some presentations were done well but more than half spoke over the level of the students in the class, went too fast or targeted topics that may have been off the most important topics in the class. I will be teaching this course again Spring of 2014 and I will try this again but I will work with each group individually before they present to do quality control.

Discussions of the direction of healthcare and future healthcare systems were well received. Balancing monitoring and information gathering against security and privacy was augmented with a guest lecturer on an imaginary electronic medical record system. Again tradeoffs were discussed in class. Example systems were introduced and discussed. Looking at the direction of healthcare monitoring allowed the introduction of ethics related topics. Not only privacy and security issues but also issues surrounding legal issues around embedded electronics in humans and what are acceptable danger levels from devices like cell phones.

### **Techniques to Keep Students On-Track**

The large number of students in the class and the variety of projects being carried out made it necessary to provide individual feedback to each group. The technique I tried in class was to have students post to Google-Docs or DropBox and then had them share the folder with me. The document would start out as an empty document with just the proposal at the head and then titles for the various sections that should be filled in as the quarter progressed. At a specified day and time the plan was for me to go into that document, make comments and suggestions on technical



points and on their progress. I felt this would be useful in keeping track of who was falling behind as well as give me time to research topic that I didn't know enough about to make a useful comment. Unfortunately technical difficulties kept this system from working (though it worked well in a subsequent design class) and I feel I let the students down in the area of support of their projects though the Google-doc. I plan on using this system when I teach the class again. This technique seemed to work well on getting the reports in on time in that each week they were just filling in empty spaces in what was originally their proposal. The documents were supposed to prepare me for weekly meetings with the groups. As mentioned, this didn't happen but the weekly meetings in lab did work and allowed me to redirect or correct groups if needed and to give me an idea of where the group was in terms of their schedule. The paper trail that a Google-doc would have provided would have been useful.

### **Assessment**

This was a major problem for me and must be improved in future quarters. The course was to be assessed largely on the project but also on participation, presentations and report. The good news and the bad news is that all groups applied themselves seriously and produced outstanding products. Attendance was solid and presentations all good. I didn't have a midterm and had a very hard time separating one person's grade from another. At the beginning of the quarter I did not predict the quality and success of the projects done in the class. From the 9 projects, 5 or 6 papers will be going out to conferences such as EMBS (IEEE Engineering in Medicine and Biology) conference, IEEE Healthcare Innovation Point-of-care technologies conference, and others. This is inspiration to have the students write a conference-like paper in the class that can be sent in almost as-is to a conference later. Because of the quality of the projects, we had a mini-expo in the lobby of the electrical and computer engineering building that was open to students and faculty where the students presented their project through demos and posters. Again the challenge was that all students did an exemplary job and I had very little to separate the students grade-wise.

When I teach the course again, I plan on having more assignments including weekly short summaries of the reading and questions on the reading and class as homework. The course, as I ran it, had assignments every two weeks. That was not enough to separate grades or truly see if a student was keeping up with the material. The presentations were given a done/not done grade and that will be changed to a score in various aspects such as preparation/organization, completeness, presentation as well as scoring the audience for attendance on those days. The course does not lend itself well to a midterm but I hope an improved effort to check up on them weekly will improve the quality of assessment.

### **Project Groups**

There was a total of nine projects attempted and those projects ranged from individual projects to two groups with six people. The division of labor was left to the groups but I required them to list up the task assignments for each individual in their initial proposal. Due to this class only being taken seniors and graduate students, the student had already had multiple years of experiences at picking project groups, planning projects and negotiating. The myriad of lab and project classes that Cal Poly students take seems to have prepared the groups well for not just the technical aspects of forming a successful group, but also the managerial aspects of forming a successful group. An example of a successful group is a group that wanted to investigate clear circuits and

how they could be used in medical technology. The group had six members and the tasks were divided up in the following way:

**Group leader (EE):** power transfer to contact lens / printing of circuits on lens

**CPE:** Application prototype to put onto lens (built successfully but not to scale)

**Biomed:** Materials appropriate for being printed on AND appropriate for use in an eye

**EE1:** Building of model eye to test contact lens.

**EE2:** Energy scavenging through light and energy storage.

This group printed out a prototype on a hard contact lens that received power wirelessly (in 7 weeks!). This project interested them enough that it is now the group leader's MS project. The group has applied for and received money for two grants and now has six members. A great contribution by the members of this group in fabrication of clear very small batteries that would fit on a contact lens. Tests are being done now and results should be available before Summer. The biomed major is following up on manufacturing. He is looking at materials and safety issues of circuits on the eye. This class was the catalyst needed to start a multi-disciplinary team that now involves four departments. Another project was done by a single biomed student that had had trouble getting information for his MS that was heavily EE. This class allowed him access to EE students and information that helped him in his biomed work. A group that did an impressive job of management did an EEG project that gathered EEG data and then sent it to a cell phone where it was displayed.

**Group leader (EE):** Programmed an app for his phone that received data from his computer wirelessly and then graphed and displayed it.

**Biomed:** Used 3D printer to create a variety of shaped electrodes and tested them for their performance as dry electrodes.

**EE:** Built amplifier that goes on electrodes plus the processing hardware that creates the signal to be transmitted to the phone.

**Psychology:** Used a database of brainwave shapes to compare to gather brainwaves.

The challenge of doing such a project in just, effectively, 7 weeks, is that if there is an unexpected problem, the project can get completely off-track. The amplifiers bought for this project came from a faulty batch and caused this group to waste 2 weeks on talking with the company and fighting to get the devices to work. A new batch was provided free of charge by the company and those worked first time. But they had already lost 2 weeks and did not get to attempt the comparison to the database waveforms. Other projects included a hand gesture wheelchair controller, sound altering headset for relaxation, glucose meter, eldercare diary system to detect long-term physical and mental health, a "fall" data gathering system, and heart rate monitor that uses changes in face color to determine heart rate. The last project used the fact that your face changes color imperceptibly every time your heart beats. These students took a non-real-time algorithm from a research group at MIT and made it real-time. Again, all of these groups found their projects, organized their groups, planned their schedule and carried out their own research.

## Conclusion

An interdisciplinary medical technology class was offered Spring 2013 at Cal Poly, San Luis

Obispo under the electrical engineering department heading and officially called “Computer Systems”. It was open to any student with upper division or graduate standing. Projects were of their own choice as was the schedule and task assignment in carrying out those projects. The skills Cal Poly students learned through many labs they had to take before this class helped them make mature, quality decisions and the projects were largely successful. The labs were a success resulting in at least one patent application, multiple multi-disciplinary Masters and senior projects and the creation of a continuing joint research project involving materials, biomedical, electrical and graphics arts that has gotten attention nationally.

The lecture was difficult due to the mixed experiences and knowledge of the students taking the class. I presented the lectures for the first half of the class trying to build a big picture view of systems for healthcare and then, as we tried to go into more depth on some topics, I had the students that were experts in the topics teach the other students in the class to keep them participating in the course. This didn't work as well as I would have liked and I will preview presentations if I do this again. Some presentations were done well but more than half spoke over the level of the students in the class, went too fast or targeted topics that may have been off the most important topics in the class.

Assessment was another challenge due to every student fully participating and succeeding in the class. More assignments needed to be assigned to see if students are keeping up weekly rather than every other week. Questions on the reading will also be given to further guide the students through the important points of the reading. The student evaluations were in general positive about the course though I think there were students that would have liked to have gotten more from the lectures.

## **Appendix A: General Course Schedule**

### ***Week 1***

**Lecture:** Definition of computer systems with humans as a component, traditional and new medical technology introduction with a short introduction to technology that has made these systems possible. (To help with decisions on projects). Short introduction to reading: Electronic health records. Proper language when discussing people with challenges.

**Assignment:** Reading of papers on security, privacy, HIPAA (Health Insurance Portability and Accountability Act), and other legal and ethical issues surrounding having individuals as part of a system or having their data stored or available on a system. I assigned roles randomly to the students such as doctor at large hospital, doctor at small practice, patient at emergency room, insurer, drug sales person, identity thief, government, etc. and asked them to, as they read, try to find information that would support or not support a nation-wide (or world- wide) database of each of our health information for their interest.

**Lab:** Student introductions including department that they belong to and their research and/or project interests. Listing of problems that would be interesting or important to solve. Mingling between students to talk about interests.

### ***Week 2***

**Lecture:** A discussion with each student taking on their assigned role from the last week's reading and debating with the others why we should or shouldn't have a nation-wide (or world-wide) database of each of our health information. Continued: Traditional and new medical technology introduction with a short introduction to technology that has made these systems possible. (To help with decisions on projects). Future mental health technologies. User interfaces and dangers of various systems.

**Assignment:** Watching videos on: 1. safety of electronic devices, 2. creative health monitoring devices and 3. iPhone apps. Reading on security and ethics. Homework: Find one security breach that you thought was interesting and present to class. Reading on future HMI (human machine interfaces).

**Lab:** Group discussions of topics and interests. I participated in each group's discussion and tried to brainstorm with them.

### **Week 3**

**Lecture:** Guest lecturer on security. Presentation on security breaches from each student. Continued: User interfaces and dangers of various systems. Costs of systems. Pervasive computing. High-level technology for pervasive computing.

**Assignment:** Reading of papers on: 1. pervasive computing, 2. birth of datifacation (fiction), 3. Company webpage for keep tweeting after you are dead.

**Lab:** Proposal due with schedule and deliverables specified. Work on project. Meeting with me.

### **Week 4**

**Lecture:** AI and decision making. Presentations of project plans.

**Assignment:** Watch TED talk on prosthetics that can feel. Watch videos on Hanson Robotics (Especially TED talk and Philip K. Dick Android). Reading of papers on: 1. Pervasive computing, 2. birth of datifacation (fiction), 3. Company webpage for keep tweeting after you are dead. Discussion on-line on ethics and dangers of AI and decision making. Two entries required from each student.

**Lab:** Updated report due. Work on project. Meeting with me.

### **Week 5**

**Lecture:** Guest lecturer on autism and autism devices. First (computer architecture introduction) and second expert presentation (programming a microcontroller). (Students present to other students on technical topics that not all students in class will know).

**Assignment:** Comments and questions on presentations. Time to be spent on project.

**Lab:** Updated report due. Work on project. Meeting with me.

### **Week 6**

**Lecture:** Powering mobile systems. Third (How to make a processor faster) and fourth (BioMed or psych student presentation) expert presentation on topics assigned in class. (Students present

to other students on technical topics that not all students in class will know).

**Assignment:** Comments and questions on presentations. Time to be spent on project.

**Lab:** Updated report due. Work on project. Meeting with me.

### *Week 7*

**Lecture:** Fifth (How memory works), sixth (BioMed or psych student presentation) and seventh (sensors) expert presentation on topics assigned in class. (Students present to other students on technical topics that not all students in class will know).

**Assignment:** Comments and questions on presentations. Presentation in lab of challenges faced in designing project. Design review.

**Lab:** Updated report due. Work on project. See “Assignments”.

### *Week 8*

**Lecture:** Design metrics, documentation of project and report format. Eighth (Communication – networks, protocols, wireless communication, etc.) and ninth (BioMed or psych student presentation) expert presentation on topics assigned in class. (Students present to other students on technical topics that not all students in class will know).

**Assignment:** Comments and questions on presentations. Time to be spent on project.

**Lab:** Updated report due. Work on project. Meeting with me.

### *Week 9*

**Lecture:** Advanced computer system topics. Tenth (big data) and eleventh (BioMed or psych student presentation) expert presentation on topics assigned in class. (Students present to other students on technical topics that not all students in class will know).

**Assignment:** Comments and questions on presentations. Time to be spent on project.

**Lab:** Updated report due. Work on project. Meeting with me.

### *Week 10*

**Lecture:** Picture of global pervasive computing and system requirements. Clouds and data that follows you as you move to different places on the earth.

**Assignment:** In class, student short presentation on what they realized this quarter about computer systems or medical technology that they didn’t know before. Reports due. Demonstration at exhibition of class products in main electrical engineering building.

**Lab:** Demonstrations.

## **High-Efficiency Inverted Instruction: Doubling Capacity while Preserving Small Classroom Quality**

Clint Staley and Michael Haungs  
California Polytechnic State University, San Luis Obispo

### **Abstract**

The inverted or “flipped” classroom model of teaching is growing in popularity and used in both K-12 classrooms and higher institutes of learning across many disciplines. Published benefits of this model include higher student engagement, increased peer learning, lowered student frustration, and the ability of the instructor to provide immediate, direct feedback to students. However, this model requires a substantial investment of time from the instructor to properly prepare and distribute material that would have been covered in a traditional lecture. At the same time, there is substantial pressure on universities to lower tuition costs and use more efficient models of teaching such as MOOCs. In this paper we discuss a model for flipping classrooms that quickly amortizes the initial instructor investment and addresses the university need to reduce costs. At Cal Poly, San Luis Obispo, we converted one of our highly impacted core programming courses, CPE 357 Systems Programming, to an inverted style of instruction that greatly increased instructional throughput without significantly increasing instructional costs. Under our high-efficiency model, we can minimally double the sections covered by a single instructor, with student support, while preserving the same quality of education received in our traditional, small-classroom method. In our paper, we fully describe our inverted model, share our experiences with it, and provide initial data supporting our claims.

### **Introduction**

The inverted classroom model of teaching has widespread appeal in the educational community. The classroom is inverted or “flipped” because the lecturing occurs at home and activities are done in class. Recent advances in online and educational technologies facilitate off-site lecturing, freeing the course instructor to guide students through challenging activities in class. It seems this model has hit the sweet spot between incorporating online educational technology and providing quality face-to-face time with students. Published benefits of this model include higher student engagement, increased peer learning, lowered student frustration, and the ability of the instructor to provide immediate, direct feedback to students.<sup>1,2,3,4</sup>

Flipped classrooms are gaining respect as a middle ground between traditional instruction and Massive Open Online Courses (MOOCs). While the efficiencies and broad reach of a MOOC are attractive, the MOOC approach suffers very high dropout and failure rates.<sup>5</sup> And MOOCs are not suited to all students, as shown for instance in the difficulties faced by San Jose State University in their experiment with Udacity, offering remedial classes online. For these reasons, we've focused on the inverted model, augmenting it to modestly increase availability and thus throughput for selected classes, while carefully maintaining instructional quality and individual student attention and interaction. Specifically, our augmented version of inverted instruction allows our faculty to roughly double the number of sections they can teach of a particular class in an academic quarter. We hope that augmented inverted instruction might provide a measured and constructive response to the call for greater efficiency and cost reduction in higher education.

Most inverted instruction experiments maintain the same instructor/section ratio as traditional classes. But the model we've spent the last 18 months developing and refining involves one instructor teaching multiple parallel sections with TA support. Our model, which we term high-efficiency inverted instruction, allows us to reap the benefits of inverted instruction for certain courses without reducing our student success rate. Below, we fully describe our inverted model, share our experiences with it, and provide initial data supporting our claims.

### **High-Efficiency Inverted Instruction**

We have made key changes to the classic inverted instruction model in order to scale it up to handling 200+ students. Before describing our model in detail, we first provide guidelines for choosing which courses are appropriate for high-efficiency inverted instruction.

*Which Classes Are Suited.* Like all things, pedagogical models should be used in moderation and applied only where appropriate. MOOCs, online learning, inverted instruction, classical lecturing and others have potential uses in any curriculum if applied judiciously. In the same way, the model we describe is suited only to certain courses. The necessary conditions a class must meet are:

1. A significant number of sections taught per term, at least enough to occupy two full-time instructors.
2. Subject matter suitable for recorded lecture.
3. Reasonably mature student body able to work with online materials requiring good self-discipline, e.g. not fall term freshmen.
4. Subject matter that does not rapidly evolve, so that investment in recordings and perhaps automated grading is worthwhile.

It is also helpful if most student homework and projects are evaluable by automated systems. Point 2 is of particular interest. Experience with online instruction of remedial students, such as the Udacity experiment at CSU San Jose, suggest that the less structured nature of online teaching may be a poor fit for remedial or less mature students.

*Description of the Model.* Our high-efficiency model follows the standard inverted instruction practice of recording lectures for viewing outside of class, reserving class time for projects and student assignments, with coaching and assistance from the instructor. The essential elements we add to this are:

1. A rigorous and highly selective process of hiring and training student TAs
2. One instructor running multiple sections of the course in parallel, with TAs supporting the instructor
3. Office hours held both in person and via email and course wiki

Two important additional elements, not strictly essential, are:

1. An automatic grading system that goes beyond the standard online multiple-choice or short-answer tests
2. Full transcripts to accompany the recorded lectures

*Highly selective hiring and training.* Using TAs to assist instruction is nothing new, of course, and is sometimes controversial. There is evidence, however, that TAs can improve face time for classes having 30-50 students.<sup>6,7,8</sup> What makes our model different in this regard is the selectivity of our hiring process and the very close teamwork between TAs and course instructor during the inverted instruction sessions. The quality of TAs is essential to the model's success. We hire excellent students who are good communicators, often inviting promising students in one term of the course to apply for TA roles in later terms. Our hiring process includes discussion of teaching methods, role-playing walkthroughs of instructional scenarios, and trial sessions in our student tutoring center, under observation of experienced tutors. Less than half of candidates make the bar. We also run a small course specifically devoted to tutoring and teaching methods for our subject area. This year we'll be adjusting the course so that it may be taken every term, for 1 unit of credit, by the inverted-instruction TAs. And importantly, we use TAs only for student coaching, whatever hand-grading may be needed, and fielding routine student Emails, all under instructor supervision. The inverted model obviates the need for TAs to give lectures, or design course content, and any serious student concerns regarding course pressures, academic advising, etc. are referred to the instructor. The instructor's role is a mix of refining and improving recorded course content and automated exercises, direct interaction with students in lab sessions, coaching and management of the TAs, and dealing with non-routine student questions requiring more experienced judgment.

*Running multiple parallel sections.* We run multiple sections of the course in parallel, in adjacent lab rooms, typically with one TA per room and the instructor rotating between rooms. This time is devoted to helping students do course homework and projects. This allows the instructor and TAs to provide typical flipped classroom activities in the same timeframe of one course. A typical course day starts with the instructor and TAs holding a brief standup conference. TAs share any instructional issues they have observed (e.g. common student difficulties with an assignment, lecture clarifications that might be useful, questions regarding how best to address a point of confusion on an exercise). The instructor offers guidance and makes decisions on issues as needed. As class starts, the instructor rotates through each section to make daily announcements. These are posted online as well, but briefly delivering them in person gives contact time with the instructor at the start of each class. The instructor then observes the TAs working, offers guidance on tutoring methods, and also works directly with students in order to maintain a good understanding of student challenges.

*Office hours via email.* The instructor holds regular in-person office hours, and there is an in-person evening tutoring center staffed by students. But, most out of class assistance is done via Email, with TAs sharing the load of fielding Email questions, and the instructor overseeing the Email interaction via CCs. Such oversight generally takes little instructor time once TAs have been trained. Questions that are common, and of value to the entire course, are posted onto a course Wiki. This system provides students with assistance at almost any time, generally within a few hours of sending an Email.



*Automated grading system.* The 357 course uses a mastery model that includes dozens of small programming problems illustrating course concepts, along with larger programming labs, and two major projects. All must be completed perfectly in order to pass the class, and students generally require multiple tries per assignment. While all student work could be hand graded, a good automated grading system saves TA and instructor time. Our system is hand-built by one of the authors, and offers automated grading of programs, style checking, and a metric for code complexity. Mastery learning – requiring perfect completion of all assignments -- is not essential to the model under study, but it does illustrate that an inverted model can still be highly rigorous.

*Lecture transcripts.* All recorded lectures come with full transcripts. Students consistently indicate in surveys that both lecture recordings (voice and video diagrams) and full transcripts are valuable. The former serves visual learners better and is best for fast review or searching for information, and the latter serves auditory learners better, and helps many students focus when absorbing the material. A less obvious benefit of transcripts is that when errors are found in the lectures it's easy to redmark-edit the transcripts, without needing to redo the recordings, if students understand that they must read the transcript in parallel with listening to the recording. A small number of transcript-only edits are tolerable in this case, with revision of the recording (which is much harder) needed only for major changes.

### **Assessment**

We offer approximate measures of the instructional success of this model in two forms – failure rates and surveys. Because of resource constraints, we could not offer both a traditional section and our high-efficiency inverted model at the same time in order to do a more formal assessment of our inverted model. As mentioned in the future work section below, we plan to do more assessment in the 2014-2015 academic year.

*Failure rates.* The first is a comparison of failure rates between a traditional pair of sections of 357 taught by Dr. Staley in S '12, vs the high-efficiency sections he taught in F'12-F'13. 357 is a notoriously difficult class, and the mastery model makes it even harder. The failure rate in the traditional sections was 30%, which is not rare for difficult CS courses. Average failure rates for the 4 terms (14 sections) thus far taught under the inverted model were 25%. These data may only be taken as rough indications, as the inverted model used somewhat less challenging projects than the in-person S'12 course, and the mastery model that was introduced in S'12 tended to produce a small but significant body of repeat failing students in the following quarters (a few as many as 4 times). The first factor would skew failure rates for the inverted model downward; the second would skew them upward. In all, though, both the available hard data and instructor and student subjective impressions indicate no significant change in failure rates under the new model.

*Surveys.* More data may be drawn from student surveys that were conducted after each of the 13 sections, totaling 282 respondents. Several questions relating to the inverted model are relevant. One asked the relative usefulness of various aspects of the course, on a scale from 1 (not useful) to 10 (highly useful). In descending order of usefulness these were:

7.9 Projects

7.8 Recorded lectures and transcripts

- 7.6 Labs
- 7.6 Automated homework problems.
- 6.7 In-class assistance
- 6.4 Email communication
- 6.2 Live office hours

Interestingly, live office hours trailed the pack, and the recorded lectures took first place. In general, online and automated aspects of the course scored moderately higher than in-person elements. Student comments indicated that recorded lectures were popular because they could be replayed when a concept was difficult, or when the student's mind wandered. Many comments also noted the clarity of the lectures, which we believe is largely attributable to delivering the lectures from transcript rather than ad hoc or from notes. A follow-up question specifically asked the students to rate the relative value of transcripts vs recordings. Given the investment required to fully transcript the course, we almost wished for an indication that they were not needed, but instead, we found that students valued the transcripts a little more highly than the recordings, with 1-10 ratings thus:

- Transcripts
- Recordings

A second body of survey questions asked for comparisons between the inverted model and a traditional model, again on a 1 (strongly disagree) to 10 (strongly agree) scale. The results for the following questions were:

- This course taught me at least as much as a typical in-person course
- I prefer in-person instruction to this online model
- I think teaching 357 this way is a good idea

So, students were nearly evenly divided on whether inverted instruction or traditional instruction was preferred, and overall favored inverted instruction for 357 in particular.

### **Impacts on Efficiency**

Experience in teaching 13 sections under this model indicates that an instructor can teach roughly twice the usual number of sections with no increase in workload. In addition, the marginal cost per section drops as more are added, so varying loads per term are easier to manage. In the current term, Dr. Staley is teaching 7 parallel sections of the course to accommodate an unexpected burst of student enrollment. While this would not be a sustainable load long-term, it is manageable for one quarter. The low marginal cost per section also eliminates the "half section" problem, in which demand exists only for about half of a class, forcing either leaving some students unserved, or filling an (expensive) section only halfway. Indeed, for the past year, no student has been turned away from 357 for lack of room.

### **Related Work**

MOOCs presently represent the most talked about method for providing education to a large number of students. While suitable for certain audiences, such as industry professionals, MOOCs suffer from significant plagiarism and severe dropout rates. As a teaching university, we did not feel MOOCs were a viable option for our curriculum.<sup>5</sup> Lockwood and Esselstein suggest that inverted instruction is a good fit for computer science courses<sup>9</sup> and report positive results. In

addition, Talbert claims that flipped classrooms could possibly scale well with appropriate TA support.<sup>8</sup> Encouraged by this work, we felt we could develop a model that implemented inverted instruction in a highly efficient way. Largent reports on his positive experience with using inverted instruction in a large CS0 course. We were encouraged by his initial work and have developed a model that has been tested for scenarios involving many more students.

### Conclusion

During the Great Recession, our model allowed us to save enough teaching resources to preserve small class sizes in other courses and was a better alternative, in our minds, than pure online courses. We are pleased with initial results and plan to continue teaching our systems programming course in this way.

### Future Work

We plan further assessment on the high-efficiency model. In the next academic year, we plan on doing the following:

1. Conducting a small group instructional diagnosis during the teaching of 357 Fall 2014. This is a service provided by our campus' Center for Teaching and Learning and will help us gauge the student learning environment created by our inverted instruction model.
2. Revising the inverted model to come closer to traditional lecture, by offering one or two of the multiple parallel sections as standard lecture, in exchange for students being graded for lecture attendance, to ensure students select standard lecture only if they mean to attend. While this will self-select students, a comparison of relative performance between students attending standard lecture and those taking the fully inverted option may be of value.

### Bibliography

1. DesLauriers L, Schelew E, and Wieman C (2011). Improved learning in a large-enrollment physics class. *Science* 332: 862-864.
2. Pierce, R. (2013). Student Performance in a Flipped Class Module. In R. McBride & M. Searson (Eds.), *Proceedings of Society for Information Technology & Teacher Education International Conference 2013* (pp. 942-954). Chesapeake, VA: AACE.
3. Tina Rosenberg (2013). Turning Education Upside Down. *The New York Times*. October 9, 2013. <http://opinionator.blogs.nytimes.com/2013/10/09/turning-education-upside-down/>
4. Bergmann, J. & Sams, A. (2012). Flip your classroom: Reach every student in every class every day. Washington, DC: International Society for Technology in Education.
5. Mark Guzdial (2014), MOOCs Need More Work; So Do CS Graduates, *Communications of the ACM*, vol. 57, no. 1.
6. David L. Largent (2013). Flipping a Large CS0 Course: An Experience Report about Exploring the use of Video, Clickers, and Active Learning. *Journal of Computing Sciences in Colleges* 29(1), 84-91
7. Gannod, G.C, Burge, J.E. and Helmick, M.T. Using the Inverted Classroom to Teach Software Engineering. In *ICSE 2008*, Leipzig, Germany.
8. Talbert, R. Using MATLAB to Teach Problem-Solving Techniques to First-Year Liberal Arts Students. MathWorks, Inc., 2011
9. Lockwood, Kate and Esselstein, Rachel (2013). The Inverted Classroom and the CS Curriculum. *SIGCSE 2013 Proceeding of the 44th ACM technical symposium on Computer science education, ACM*, 113-118.

## **Application of Project-Based Learning (PBL) Method in a Senior Year Engineering Design Course**

Moe Tajvidi  
Utah State University

### **Abstract**

In this paper, application of project based learning (PBL) methodology in teaching civil engineering courses is investigated. Project-based learning method, although closely related to problem-based learning, has significant points of difference. While the latter addresses introducing real life mainly ill-structured problems to students as a learning resource, the former is known more in the sense of structuring of a full project, which may or may not include a real open-end problem. The literature concerning this methodology which focus on its application in engineering design teaching is briefly reviewed in the paper. Project-based learning focuses on using predefined projects as teaching tools in order to simulate the conditions of real life projects, on the other hand, in problem-based learning method the problems presented to the learner as replications of ill-structured problems in the real life settings of that field. As an example for project-based learning practice, process of incorporation of a design project in 'foundation design' course is described. Significant changes were observed in students' understanding and attitude towards foundation design concept in engineering. The subject of this case study 'foundation design' course is a senior year civil engineering course and the process and findings of during implementation of PBL method conducted by the author are described. Based on the previous literature as well as this study, a number of recommendations for the future are given.

### **Introduction**

In engineering education two topics have drawn attention as considerably popular approaches. Problem-based learning and Project-based learning; the acronym for both of them is PBL. Although they have similar applications, they differ in certain ways. In addition, sometimes Design Based Learning (DBL) is addressed; it might seem to be in the same context as PBL, which is not the case. Problem-Based Learning is not limited to engineering education; it has been long used in other areas such as medicine education, nursing education and law education.

There have been many efforts to improve the quality of teaching of soil mechanics and foundation design courses, for example, using audio response systems to develop active learning environment within the classroom has been investigated<sup>3</sup>. In another attempt to incorporate learning outcomes into an introductory geotechnical engineering course<sup>9</sup>, a listing of outcomes articulated for several foundation design course topics has been developed which demonstrates how the outcomes were linked to lesson plans and assignments. In this regard, example assessment methods and results are presented with the results of teaching evaluations, which indicate that students value this approach to course design. The above approach is known to be implemented in upper-division courses, helped to improve course structure and define expectations regarding student learning more clearly<sup>9</sup>. It gives profoundly beneficial results for engineering education as a result of the features it incorporates. Up to now, a brief literature review demonstrates that majority of articles on project-based learning are course descriptions focusing on the implementation of individual courses, whereas research studies which focus on

the topic theory and content are relatively infrequent<sup>21, 17, 15, 7</sup>. Furthermore, the term “project-based learning” subsumes different activities with varying purposes and is frequently replaced by problem-based learning. Based on the literature in civil engineering education, because of the hierarchical nature of engineering education, PBL is best applied in a hybrid form known as Project Based Learning<sup>11</sup>. This hybrid project-based learning form is different from problem-based learning in the aspect of (1) time, which means that engineering projects take more time than problems, (2) application: which means that the projects are focused on application of the knowledge while problems focus on acquiring knowledge, (3) sequence; projects advance through meaningful sequence of activities, while problems are self-supported activities, (4) time management is a key issue in projects because of the sequence, (5) self-direction is stronger in project-based learning as learning is directed by the problem<sup>11</sup>.

### **Project-Based vs. Problem-Based learning**

Problem-based learning is an approach to learning that has grown in breadth and depth across the world since the 1970s, yet the bulk of the literature concentrates on practical applications of problem-based learning in particular settings rather than on the examination of the complexities and challenges involved in its application<sup>27</sup>. Project based learning is defined as “a systematic teaching method that engages students in learning knowledge and skills through an extended inquiry process structured around complex, authentic (real-life) questions and carefully designed products and tasks”. On the other hand, problem based learning is identified as an instructional method in which students learn through facilitated problem solving that centers on a complex problem that does not have a single correct answer. In this context, Project-based learning can be extended to meet problem based learning characteristic, projects can contain ill-structured problems, with multiple solutions<sup>6</sup>. While there are distinctions that define problem based learning and project based learning, these and other inquiry approaches are similar in that they engage students as researchers, urging students to learn how to ask critical questions, execute a design and investigate, collect, analyze, and interpret data, and apply those data to new situations. Although in almost all senior year engineering courses effort is made to introduce students to real-life problems which are to be solved, the problems given to the students can not represent workplace settings completely. Workplace problems are ill-structured and complex because they possess conflicting goals, multiple solution methods, non-engineering success standards, non-engineering constraints, unanticipated problems, distributed knowledge, collaborative activity systems, the importance of experience, and multiple forms of problem representation<sup>18</sup>.

There are a number of essential features of problem based learning, including an interdisciplinary approach, activities that are valued in the real life and ill structured problems. These essential features imply that students must have responsibility for their own learning. They also show the necessity of student collaboration. Additional features on the list include self-efficacy and peer-evaluation, and regular evaluation of student progress learning. To conclude, problem based learning must be the pedagogical basis of the curriculum, rather than part of a didactic curriculum. Considering the close resemblance between project-based learning and problem-based learning, differentiating between the two approaches doesn't always happen and both of these pedagogical approaches are referred to collectively as PBL. By addressing the current literature in this field and relevant research studies in closely related fields, it can be observed that the concept of ‘design based learning’ (DBL) is frequently addressed. DBL is an educational

approach grounded in the processes of inquiry and reasoning towards generating innovative artifacts, systems and solutions. It employs the pedagogical insights of problem-based learning PBL<sup>13</sup>.

Problem based learning has a long background in medicine education, nursing education and law education, considering that problem-solving process in these fields is a routine practice and students should be prepared to address critical situations in which expert knowledge need to be conveyed with creativity and ability to transfer knowledge to practical action. In these areas problems are focused rather than projects. Problem-Based Learning as a general model was developed in medical education in the early 1970's and since that time it has been refined and implemented in many medical schools. The most extensive application of the PBL in medicine education is in the first two years of medical science curricula where it replaces the traditional lecture based approach to anatomy, pharmacology, physiology etc. The model has been adopted in an increasing number of other areas including Business Schools, Schools of Education, Architecture, and Law<sup>29</sup>.

In a general sense, the comprehensive definition of Project based learning is known as a valid definition. In this definition PBL should have five major elements<sup>1</sup>:

1. [Projects] involve the solution of a problem; often, though not necessarily, set by the student himself [or herself].
2. They involve initiative by the student or group of students, and necessitate a variety of educational activities.
3. They commonly result in an end product (e.g., thesis, report, design plans, computer program and model).
4. Work often goes on for a considerable length of time.
5. Teaching staff are involved in an advisory, rather than authoritarian, role at any or all of the stages - initiation, conduct and conclusion

Although items (1) and (3) seem to be the crucial elements of Problem-Based Learning, existence of a problem or project in learning is essential<sup>16</sup>. This project is often similar to real life settings' problems, and the students are supposed to approach it in order to organize and drive activities leading to solution which represents an integrated learning objective. University projects are developed so that the students undertake their own fact-finding and analysis<sup>2</sup>. In design courses the project deliverable that comes from the project is usually in the form of an engineering design package, including design drawing, booklets and data sheets. Engineering students have the opportunity to apply the concepts they learn in the classroom to hands-on projects similar to real-world applications. Students from all engineering majors enjoy the teamwork, meaningful problem-solving and hands-on design that accompanies projects of the course. Projects can focus on creating innovative solutions to real-world problems although this method can be difficult for a novice practicing designer. In that case, more structured projects can be developed which can be conducted usual routines.

Project-based learning in engineering education, specifically in teaching design practice is a common feature, six project types and four domains and eleven sub-domains which relate curriculum design and pedagogical strategies can be identified<sup>21</sup>. Regarding the theoretical framework attributed to project-based learning method, organizational learning is one the best to

fit the image. There are conditions that can promote learning within projects, to exploit elsewhere in the organization<sup>26</sup>. This leads to adopting a broadly based approach which observes learning at multiple levels of analysis (individual, project, organizational) and addresses not only project-based activities, but also the organizational context in which such activities unfold. More review of literature will reveal that there can be found many documents which are unit describing the implementation details on individual courses. In general freshman courses, PBL has a significant role<sup>15</sup>.

### **Design Course and PBL**

Combining PBL with self-regulated learning, the stages of a project in learning settings are classified into three phases<sup>6</sup>. Although the project cycles for the students include: questioning, researching, applying logic and reasoning, developing and testing hypotheses, evaluating evidence, synthesizing information, and integrating peer and teacher input that lead to deeper levels of understanding. These cycles occur in three main phases: 1) project/problem launch, 2) guided inquiry and product/solution creation, and 3) project/problem conclusion. In a study evaluating PBL application in an undergraduate program, it was found that the students enjoyed the course offering with PBL and demonstrated deeper understanding of the required knowledge<sup>15</sup>.

### **Practical Example**

The course in which PBL was incorporated has been “foundation design”, a senior year course, taught in all civil engineering programs with different titles and mainly the same content. The primary goal of this course is to give the students the ability to design foundations for structures. The course was held taught in spring 2011. As an undergraduate course, the course addresses usually customary types of foundations. Design of foundations for complex structures such as complex machinery foundations, heavy industrial structures and hydro-structures (dams, offshore jackets, jetties etc.) is beyond the scope of this course; although a brief description of them will be given within the course material. At first, a brief review of previous knowledge is conducted. The basic design issue in the simplest type of foundations will be addressed which is the bearing capacity concept. Foundation settlements are next. In preceding chapters, two major types of pile are discussed and their design issues are explained. In the last chapter, another major earth structure is presented, which are the retaining walls. By completing this course, the students should be able to read and analyze geotechnical reports, decide about the type of foundation needed for a certain project, design the foundations and prepare the design documentation. The configuration of the course material can be set carefully so that the students develops a concrete ability to successfully start, conduct and terminate a foundation design process.

### **Course Objectives and Modules Design**

Foundation engineering is an important course in civil engineering. Every structure should be stable and safe on the ground. Instantaneous and long term deformation in the soil beneath every structure can cause serious damages to stability and function of the structure. Therefore, foundations are major elements in all civil engineering structures. As mentioned before, the ultimate goal of this course is to enable the students to perform engineering design practice for foundations. In detail, after successful finishing of this course they should be able to:

- Analyze and verify the geotechnical data gathered from field and lab tests.

- Use the soil data to calculate the parameters which govern the foundation behavior such as stress parameters, settlement, deformation etc.
- Choose the required tests for any type of soil and place order for that test if it does not exist in the primary tests list.
- Evaluate the input data in order to decide what type of foundation is best working for that condition.
- Decide between different types of foundations for a project and conduct a quick evaluation of design issues for each type and select the best option.
- Assign preliminary dimensions to the foundation (shallow or deep) which is to be designed and conduct an analysis.
- Check those parameters such as dimensions, material properties etc. for compliance with the assumptions, real conditions and practice codes and standards.
- Present the design output in the form of drawing, reports and oral presentation.
- Be able to justify the design process verbally if needed and troubleshoot the construction issues.

The course modules are developed to cover this process for three major types of geotechnical structures: shallow foundations, deep foundations (which includes piles and caissons), and earth retaining structures. Each type will be defined and explained systematically within the course. At the end of the course the students are deemed to be able to analyze soil and structure data, use these data to design the foundation and be able to submit a comprehensive, clear and self-sufficient design package. There are six major modules in the course. Here is the overall course schedule.

Table 1. Foundation design course modules.

Course module	Chapters	Timeline
1. Preliminary considerations	chapters 1-4	2 weeks (W1, W2)
2. Bearing capacity of spread foundations	chapters 5,6,8-10	3 weeks (W3, W4, W5)
3. Settlements of spread foundations	chapter 7 and 19	2 weeks (W6, W7)
4. Design of bearing piles	chapters 11-13,16	2 weeks (W9, W10)
5. Design of friction piles	chapters 14,15,17	2 weeks (W11, W12)
6. Design of retaining walls	chapters 22 to 25	3 weeks (W13, W14, W15)

In a regular course presentation, in the end of module 3 i.e. week 8, a midterm exam is taken and in the conventional course, there is a comprehensive final exam at the end of the semester or week 16. By implementing the course with PBL methodology the midterm exam will be replaced by submitting of the first project and the final exam will take a form of a verbal presentation of second project.

### **Rationale for PBL in foundation design course**

In teaching design courses, training the learners to be critical thinkers, while observing the code criteria as well as being creative is a major challenge for the instructor<sup>5</sup>. There are clear differences between academic knowledge acquired in the engineering schools and the knowledge required in professional environment. According to recent report from National Academies, one



of the two major tasks required to generate desired student learning outcomes is “*better alignment of engineering curricula and the nature of academic experiences with the challenges and opportunities graduates will face in the workplace*”. There is a disadvantage in developing abstract exercise problems which are completely relevant to the topic: they represent real situations only partially. On the other hand, exposing the novices to ill-structured design problems of real life can cause distress in them. The main objective of PBL in design is to simulate the real project in an incubated environment. One of the real conditions characteristics is that input data are not always conformable, and the designer should verify the data to minimize the possible data collection error which are used as input. The verification learning objective can aptly be achieved by PBL, introducing real data and asking the students to search other sources in order to verify them. Another benefit of PBL is creating motivation in the learner because of the objectivity of the final product. Being similar to real life issues will create a sense of meaningfulness in the learner when addressing a design project. This feature has been considered by researchers of EPICS project<sup>24</sup>. The last subject which makes PBL attractive is initiation of an insight of integrated thinking in learners mind. The advantages of PBL are summarized as<sup>4</sup>: (1) Improved communication and teamwork skills; (2) Increased motivation; (3) Better understanding of professional practice; (4) Improved application of knowledge to realistic problems; (5) Improved student satisfaction and (6) Increased student learning. In a general conclusion, PBL is intended to expose students to real engineering practice experience which includes its style and language. Since it does not fit completely within the cognitive domain of learning, PBL created this opportunity because of its practical aspect. PBL gives the students the chance to look at the input data as results of questionable analysis not solid untouchable assumptions. In engineering design course, when working on a design project, students have a chance to search for similar situation, observe the differences with their own case and seek out the impacts that change in on design parameter creates in seemingly irrelevant parts of the project. In an assignment problem, the answer is a figure, unknown or number, but PBL guides the students to produce tangible outcomes called project. The activities which form the project should be coordinated in the group and monitored, which need direction:

- To expose student to the real life project environment
- To introduce the concept of verification of input and critical thinking about data
- To change the target of course problem solving into a more fruitful tangible deliverable
- To develop the self-directed group activity
- To initiate a sense of engineering judgment

### **Variations to the classic course components**

When introducing PBL method, the course is taught in the basic form, lecture or online, although there is limited experience with online development of this course. Also in a PBL course, the course contents, lecture note, topics and communication means in are maintained. Variations are made in the assignments, student activities and exam style. In table 2, a summary description of the changes in the course design is presented. These changes include the student activities and student evaluation.

Table 2. Comparison of the course activities, regular course and PBL course.

<b>Regular course</b>	
Activities	
Assignments	
	Assignment 1- an independent problem on calculation of bearing capacity of spread foundations
	Assignment 2- an independent problem on calculation of settlements
	Assignment 3- an independent problem on calculation of dimensions of bearing piles
	Assignment 4- an independent problem on calculation of dimensions of friction piles
Student Evaluation	
	Assignments 30%
	Midterm exam 30%
	Final exam 40%
<b>PBL course</b>	
Activities	
Assignments	
	Verification of data – to be discussed in the 2 <sup>nd</sup> week review session
	Preparing design brief- to be discussed in the 3 <sup>rd</sup> week review session
	Checking the topic for design, to be discussed in the 4 <sup>th</sup> week review session
	Estimating and Calculating the dimensions based on capacity, to be discussed in the 5 <sup>th</sup> week review session
	Section on calculating settlements, to be discussed in the 6 <sup>th</sup> week review session
	Checking the capacity and settlement criteria, to be discussed in the 7 <sup>th</sup> week review session
	Optimizing the design, to be discussed in the 7 <sup>th</sup> week review session
	Checking practical requirements (design code requirements, construction) , to be discussed in the 7 <sup>th</sup> week review session
	Packing the project documents
Student Evaluation	
	Project 1, formative evaluation, weekly discussions, 2 <sup>nd</sup> to 8 <sup>th</sup> week
	Project 1, summative evaluation, 8 <sup>th</sup> week presentation
	Project 2, formative evaluation, weekly discussions, 9 <sup>th</sup> to 15 <sup>th</sup>
	Project 2, summative evaluation, week 15 presentation

### The Course Project

Two main course projects were provided to the students. These projects were real regular design practice for ordinary buildings. The students formed groups of five individuals. For each group two projects were provided. These two projects were established in such a fashion that the design activities covered the two major topics of the course: design of shallow foundations and design of deep foundations. The design input, the building dimensions and major engineering characteristics were similar as well as geometry and general urban conditions. The parameters of the soil properties were defined so that as well as being realistic, would guide the design output in the relevant topic. The project deliverables included: major design drawings, general drawings according to the practical document list, and design booklet with standard layout. A summary of the project statement is presented here:

*Foundation design course, first and second design project.* A private owner intend to build a residential six story building, the architectural plans of which are attached. The approximate

dimensions and types of structural elements are given in the structural drawings as well. The complete design of the foundation for the building is required. The soil characteristics are provided in the geotechnical report of conducted by the owner.

In order to perform the design of this foundation, the students need to follow the following steps:

1. Review the project layout to find all the unclear point and information
2. Review the geotechnical report data and verify the internal conformability of data and similar sites
3. If possible and applicable, visit the project site to get an insight of the project
4. Estimate the general layout and dimensions of the foundation, and conduct structural analysis to reach the first estimate,
5. Calculate the deformations and stresses within the foundation and beneath it
6. Check the estimate against codes criteria
7. If the first guess satisfies the criteria, try more economical designs and repeat steps 4 to 6
8. Once finalized, check the workability and construction of the design
9. Documentation and preparing documents, starting with sketches, drawings,
10. Prepare for the final presentation and project kick-off meeting.

*Attachments to the project statement for each group*

1. Architectural drawings and plans
2. Structural before-final drawings
3. Summary structural design booklet
4. Summary geotechnical survey report
5. Design booklet outline template,
6. Template drawing and title block

All designs are established in a way to maintain consistency of the design booklets for both projects. Effort is made to maintain the same project building for the second project and changes are limited to the soil input parameters. Thus the students can observe the required modifications in the design. In most cases the modifications are extended to design strategy, change of foundation type or substantive variation of foundation geometrical characteristics. By this strategy, the students are directed to perceive the input change in design practice. This is deliberate preparing students for critical thinking and ability to: (1) observe and adjust different input conditions and (2) track the impacts in all components of the design product.

In table 3, there is an outline of the project outcome documents. In many civil engineering programs, a design format course is not provided. On the other, engineers are exposed to these documents as soon as they start their career either in design or in construction. The objective is to introduce the students to routine documents in workspace, to prevent the strangeness of such material to a novice engineer in career.

### **Selection of the Project Types**

Several criteria were considered in selecting the term project content. It should be carefully designed and presented to meet the learning objectives and not include any complex problem in the early stages at least. Based on the students' progress and performance, some real life ill-structured issues may be raised by the instructor to draw their attention to the fact that all kinds

of difficulties can potentially occur and are to be solved. The project can be adopted from the major known engineering projects in the city or the region, to make sense for the students, for example, if the institute location university is a seaport city, example project can be closely related to port facilities. Although keeping the project difficulty level reasonably moderate in the earlier stages of the project, in the final stages the students may be asked to take some infrequent situations into account such as natural hazards, change in the general function etc. at the end of the semester, all the project reports can be placed in an exhibition in the class so that the students of the course and probably other courses can see their product. It is an opportunity for them to demonstrate and a means of motivation. Thoughtful selection of example design projects pertains to the following criteria:

- Covering all the topics basically
- Everyday design project to make sense
- Extendable in a way to address more advanced topics
- Capable of raising motivation among the students
- Simple enough to fit within one semester activity for students

Although PBL can be effective in teaching design course, the instructor may pay great attention to the method of incorporating it in teaching regarding content, time, outcomes and evaluation.

Table 3. Summary course projects' deliverables.

<b>Project deliverables</b>	
Design booklet	Design brief Verification of data Design reference codes Calculation of capacity Calculation of settlements
Design drawings	Layout /Configuration Major drawings General drawings Specific drawing Reference drawings
Design specification	Constructors reference Recommendation Spec. data Material data Inspection milestones Inspection guidelines

### **Student Feedback and Discussion of Outcomes**

Since this study was conducted in an action research setup, because of the university requirements, a final exam was taken from the students. It included a number of questions regarding the general layout and each individual's role in the project team along with an interview question asking their feeling about the course PBL methodology and the ideas (positive and negative) they found working on the projects. Almost everybody of the 20 students enjoyed the course, clearly because of the hands-on style of the course and lack of emphasis on exams. Thirteen students (65%) stated that it was their first serious teamwork experience and

everybody selected the design templates as the most significant experience in the course. Two students (10%) had previous experience with design practice working as drafters in engineering offices and believed that the method increased their motivation.

By applying PBL methodology in foundation design course, despite the higher level of workload for the lecturer, several advantageous outcomes were achieved as listed here:

1. The students were asked to verify the input data for the project. Verification process is a major element in expert analysis which is not emphasized in teaching. Once in career, they realize that input data are not untouchable parameter for design, on occasions they should be checked for validity, reliability and conformability.
2. The students experience more course involvement through meaningful team communication and guided work on the projects.
3. Majority of student experienced teamwork practice on a serious design project, which required team coordination and management.
4. All the students for the first time were introduced to professional environment components such as typical drawings and engineering practice code requirements.
5. The students on occasions face the “what happens if” question in order to realize that unlike assignment problems there is not a single design solution for projects.
6. Furthermore, slight changes in parameters and conditions can change the design solution significantly.
7. In developing projects for course teaching purpose, relatively ill-structured real life problems can be implanted within the project in order that the student discovers them while carrying out the project. Careful guidance is needed for the course instructor to lead the students to address such problems. The issues of this kind can't have a high level of difficulty and should not be considered as a routine because they are not in real life.
8. PBL method develops motivation among the students mainly because they observe the tangible directed and realistic product of the project which fits within their image of the future performance. It was obvious that working on a single realistic project for an extensive period will develop a sense of ownership and self-confidence in a learner.
9. Other skills such as presentation, team communication, and responsible conduct of duties can be mentioned although these can be accomplished through other method as well as PBL.

## Bibliography

1. Adderley, K., Ashwin, C., Bradbury, P., Freeman, J., Goodlad, S., Greene, J., Jenkins, D., Rae, J., Uren, O., (1975), Project methods in higher education SRHE Working Party on Teaching Methods: Techniques Group, Society for Research into Higher Education, Guildford
2. Chandrasekaran, S., Stojcevski, A., Littlefair, G., Joordens, M., (2012), Learning through Projects in Engineering Education, Proceedings of SEFI 40<sup>th</sup> annual conference, Thessaloniki, Greece.
3. Donohue, S., (2013), Supporting active learning in an undergraduate geotechnical engineering course using group-based audience response systems quizzes, European Journal of Engineering Education, DOI:10.1080/03043797.2013.833169.
4. Dym, C.L., Agogino, A.M., Eris, O., Frey, D.D., Leifer, L.J., (2005) Engineering Design Thinking, Teaching, and Learning, Journal of Engineering Education, 94, 103-120
5. Eder, W. E., (2013), Engineering Design vs. Artistic Design: Some Educational Consequences, US-China Education Review, 3, 259-280
6. English, C. M., Kitsantas, A., (2013), Supporting Student Self-Regulated Learning in Problem- and Project-Based Learning, Interdisciplinary Journal of Problem-based Learning, 7, 128-150.
7. Ersun, I., Kale, I, (2010). An Assessment of Project Based Learning (PBL) Environment Based on the Perceptions of Students: A Short Course Case Study on Circuit Design for VLSI, International Journal of Engineering Education. (26) 564–57.
8. Felder R.M., Woods, D.R., Stice, J.E., Rugarcia, A., (2000)The future of engineering education II, teaching methods that work, Chem. Engr. Education, 34, 26–39.

9. Fiegel, G. L., (2013), Incorporating learning outcomes into an introductory geotechnical engineering course, *European Journal of Engineering Education*, 38-238-253
10. Galand, B., Frenay, M., Raucent, B., (2012), Effectiveness of Problem-Based Learning In Engineering Education: A Comparative Study on Three Levels of Knowledge Structure, *International Journal of Engineering Education*, 28, 939-947.
11. Gavin, K., (2011), Case study of a project-based learning course in civil engineering design, *European Journal of Engineering Education*, 36, 547-558
12. Goedert, J.D., Pawloski, R., Rokooeisadabad, S., Subramaniam, M., (2013). Project-Oriented Pedagogical Model for Construction Engineering Education Using Cyberinfrastructure Tools, *J. Prof. Issues Eng. Educ. Practice*.139, 301-309.
13. Gomez Puente, S. M., van Eijck, M., Jochems, W., (2013), A sampled literature review of design-based learning approaches: a search for key characteristics, *International Journal of Technological Design Education*, 23, 717-732
14. Gómez Puente, S.M., van Eijck, M., Jochems, W., (2011), Towards characterizing design-based learning in engineering education: a review of the literature, *European Journal of Engineering Education*, 36,137-149
15. Hall, W., Palmer, S., Bennett, M., (2012), A longitudinal evaluation of a project-based learning initiative in an engineering undergraduate programme, *European Journal of Engineering Education*, 37, 155-165.
16. Helle, L., Tynjala, P., Olkinuora, E., (2006), Project-based learning in post-secondary education – theory, practice and rubber sling shot, *Higher Education* 51, 587-314
17. Hubka, V., Eder, W.E., (2003) Pedagogics of Design Education, *Int. J. Engineering Education*, 19, 799-809.
18. Jonassen, D., Strobel, J., Lee, C. B., (2006) Everyday Problem Solving in Engineering: Lessons for Engineering Educators, *Journal of Engineering Education*, 95, 139-151
19. Jergensen, U. (2012). Tensions in developing engineering design competencies, In N. H., Christensen, C. Mitchum, B. Li, & V. An. (Eds.), *Engineering, development and philosophy: American, Chinese and European perspectives* (pp. 215-231). New York: Springer.
20. Kunberger, T., (2013) Revising a design course from a lecture approach to a project-based learning Approach, *European Journal of Engineering Education*, 38, 254-267.
21. Lee, N., (2009), Project methods as the vehicle for learning in undergraduate design education: a typology, *Design Studies*, 30, 541-560.
22. NSF-ASEE joint committee report, (2013) “Transforming Undergraduate Education in Engineering” May 9-10, 2013 Workshop Report
23. National Academy of Engineering, (2005). *Educating the Engineer of 2020: Adapting Engineering Education to the Next Century*, The National Academies Press.
24. Prince M., and R. Felder, (2006), Inductive Teaching and Learning Methods: Definitions, Comparisons, and Research Bases, *Journal of Engineering Education*, 95, 123-138
25. Redkar, S., (2012), Teaching Advanced Vehicle Dynamics Using a Project Based Learning (PBL) Approach, *Journal of STEM Education*, 13, 17-30.
26. Scarbrough, H., Swan, j., Laurent, S., Bresnen, M., Edelman, L., Newell, S., (2004), Project-Based Learning and the Role of Learning Boundaries, *Organization Studies*, 25, 1579-1600.
27. Savin-Baden, M., (2000), *Problem-based Learning in Higher Education: Untold Stories*, The Society for Research into Higher Education and Open University Press.
28. Savery, J. R., Duffy, T. M., (2001), *Problem Based Learning: An instructional model and its constructivist framework*, CRLT Technical Report No. 16-01.
29. Savery, J. R., (2006). Overview of problem-based learning: Definitions and distinctions. *Interdisciplinary Journal of Problem-based Learning*, 1, 9-20.
30. Soltani, F., Twig, D., Dickens, J., (2012) Industry Input into the Education of Undergraduate Engineering Students through Sponsorship, *International Journal of Engineering Education*, 28, 982-988
31. Van Rooij, S. W., (2009), Scaffolding project-based learning with the project management body of knowledge (PMBOK), *Computers & Education* 52, 210-219
32. Vidic, A. D., (2010), Assessment in Problem-based Learning Incorporated into Traditional Engineering Education: Difficulties and Evaluation, *International Journal of Engineering Education*, 26, 554-563. Zhou, C., (2012), Integrating creativity training into Problem and Project-Based Learning curriculum in engineering education, *European Journal of Engineering Education*, 37, 488-499.

## **Engineering Literacy: Educating Prospective Elementary School Teachers to Lay the Foundation for a More Knowledgeable/Well-Prepared Generation of Engineering Students**

Fariborz Tehrani, Nell Papavasiliou, Frederick Nelson, Carol Bohlin, and Mara Brady  
California State University, Fresno

### **Abstract**

The lack of a solid foundation of engineering literacy is an obstacle to student success in undergraduate engineering program. This paper outlines an approach to address this obstacle and to generate a well-prepared generation of engineering students. There have been many outreach attempts to develop engineering curriculum for grades K-6 classrooms. Fundamental understanding of the engineering profession is an essential key for elementary teachers to implement this curriculum. The presented approach is an initial effort targeted at increasing the engineering knowledge of prospective K-6 teachers. This step involves developing a course titled Engineering Literacy, taken by those undergraduates who typically plan to enter the credential program for elementary teaching (i.e., Liberal Studies majors). Engineering Literacy is a three-unit combined laboratory and lecture course. Hands-on activities are coupled with lectures on engineering topics. Expected outcomes of Engineering Literacy are aligned with the general body-of-knowledge in both engineering and liberal studies, as well as the Next Generation Science Standards. Specific engineering outcomes include the ability to design, plan, and manage creative projects and products with respect to principles of sustainability. Liberal studies outcomes addressed in the Engineering Literacy course include accessing and using information sources, as well as the application of humanities and social sciences to engineering solutions. Common goals such as developing critical reasoning, effective communication, and recognition of life-long learning are emphasized. Students understand how an engineering solution works within technical and economic as well as social and political constraints.

In this course, students experience development of an engineering project from inception to deployment of results. The course guides students in learning from historical perspectives and consequences of engineering, in researching and communicating ideas using engineering resources, and in using practical engineering tools to deliver a sustainable and resilient solution throughout the design process. These learning experiences provide a strong engineering foundation for liberal studies majors, and particularly future elementary teachers. Anticipated outcomes are manifested and measured at different stages. The primary desired outcome of the Engineering Literacy course is that students, many of whom plan to teach at the elementary level, gain a better understanding of engineering. Further, we anticipate that such improvement in engineering knowledge among elementary school teachers will translate into greater awareness and knowledge of engineering among their students. This in turn will lay the foundation for greater student awareness of, interest in, and knowledge of engineering as a field of study in college.

### **Introduction**

*Engineering education and literacy.* The works of engineers continue to affect our lives in the twenty-first century, more than any other time in the history. Yet, there has not been substantial growth in public awareness of engineering. Surveys have shown that coordinated efforts to promote the public perception of engineering are necessary to engage public and elected officials

in the process. However, the poor performance of the K-12 education system in teaching STEM (science, technology, engineering, and mathematics) has also been a concern in recent years. As a result, engineering graduation rates have suffered in the past decades. Thus, the development of new generations of engineers remains a challenge in long-term (NAE, 2002)<sup>21</sup>. Addressing this challenge requires development of a solid foundation of engineering literacy throughout grades K-12.

This paper outlines an approach to address this challenge and to generate a more prepared generation of engineering students. Obviously, engineering is the E in STEM, and should be considered in close relationship with mathematics, science, and technology. Gorham, Newberry, and Bickart (2003) have linked engineering and technological literacy together by comparing learning outcomes of the International Technology Education Association (ITEA) and the Accreditation Board for Engineering and Technology (ABET)<sup>2, 12</sup>. Further, Hill (2006) has shown the importance of integrating engineering design in technology education<sup>14</sup>. Engineering literacy also incorporates numerous elements of learning outcomes in mathematics and science, as addressed in ABET. In addition, these outcomes need to be mapped to liberal studies and education outcomes for successful pedagogical methods, as presented in the Next Generation Science Standards (NGSS)<sup>26</sup>. An example of one such collaborative effort is a STEM concentration for the Liberal Studies major as reported by Nelson et al. (2013), Brady et al. (2013), and Tehrani et al. (2014)<sup>5, 25, 33</sup>.

There have been a number of outreach efforts to develop engineering curriculum for grades K-12, and particularly K-6 classrooms (e.g., Engineering is Elementary and Project Lead the Way). Comparative studies on the infusion of engineering materials into existing curriculum have generally indicated that high school students gain more favorable attitudes toward engineering after being exposed to such materials<sup>30</sup>. In addition, Ma, Lo, and Chan (2012) have identified grades K-6 as the optimal age period for engineering education<sup>18</sup>. Therefore, early incorporation of engineering into K-6 curriculum would facilitate discovery and development of talent in the STEM disciplines as reported by Mann et al. (2011)<sup>19</sup>. Locke (2009) also recognizes the elementary grades as the optimal time to introduce engineering curriculum that would be intensified and differentiated in middle and high schools, respectively<sup>17</sup>.

Fundamental understanding of the engineering profession is an essential key for elementary teachers to implement this curriculum. Lack of engineering knowledge, training opportunities, and incentives are major obstacles in teacher preparation for such implementation<sup>6, 10</sup>. The presented approach is an initial effort targeted at increasing the engineering knowledge of prospective K-6 teachers and overcoming the above-mentioned obstacles. It should be noted that the integration of engineering into liberal studies would also impact the engineering literacy of population<sup>3, 16</sup>. Thus, the topic of this paper has the potential to impact the general population of students. These learning experiences provide a strong engineering foundation for future elementary teachers. In the context of the course described in this paper, these future elementary teachers typically pursue an undergraduate major in Liberal Studies. The expected outcome is manifested and measured at different stages.

*Teachers: Understanding of engineering.* The most direct measure involves a better understanding of engineering for students enrolled in the Engineering Literacy course. In the



inaugural semester of the course, all students taking the course plan to teach at the elementary level. At this stage, the outcomes of the course are assessed and compared with the general Liberal Studies outcomes. Culver (2012) provided a qualitative assessment for forty-four pre-service elementary teachers<sup>9</sup>. The assessment included four topics: engineering content, engineering context, engineering pedagogy, and engineering town. Students were introduced to engineering design process (content), and how it can be incorporated in teaching science and mathematics (context). Further, educational methodologies (pedagogy) and the impact on community (town) were discussed in focus groups. Participants in this study showed limited perception of engineering and the process of engineering design. Further, they associated student's success in engineering with student's prior knowledge, not necessarily the outcome of teacher's action in classroom. Hynes (2012) performed a study of six middle-school teachers that also included subject matter and pedagogical content<sup>15</sup>. This study focused on non-engineer teachers teaching the engineering design process. Results indicated mixed levels of engineering design knowledge.

*Elementary students: Awareness of engineering.* Further, we anticipate that improvement in teachers' understanding of engineering will translate into greater awareness of engineering among elementary students. The assessment at this future stage will require observation of elementary classrooms as live laboratories. A focused set of data based on classrooms where elementary instructors have successfully completed the Engineering Literacy course compared to a general set of classrooms, will provide a qualitative base of comparison on the impact of this program on K-6 curriculum and instruction. Oware (2008) studied perceptions of engineers among eighteen elementary students<sup>28</sup>. Capobianco et al. (2011) performed a similar study to investigate factual knowledge of elementary school students about engineering<sup>07</sup>. The results were based on a draw-an-engineer test on 396 students. Both studies showed that students associate engineering with simplistic and literal meanings of an engineer, e.g., a mechanic who works with an engine, or laborer who builds a building. However, 5<sup>th</sup> and 6<sup>th</sup> graders focused less on physical activities than 3<sup>rd</sup> and 4<sup>th</sup> graders.

## Methodology

*Course purpose.* The "Engineering Literacy" is a 3-semester-unit undergraduate course developed for Liberal Studies majors—students who typically plan to enter the credential program for elementary teaching. This course may also help current as well as prospective teachers to prepare for an additional authorization in mathematics and/or science teaching, generally at the middle school level. Engineering Literacy couples lectures on engineering topics with hands-on laboratory experiences. The class meets once a week in the evening to accommodate working students, particularly those teaching in after-hour school programs. Table 1 lists course topics for both lecture and laboratory sessions.

Table 1. Course topics.

Lecture sessions	Laboratory sessions: sample activities
History of engineering	Survey of ancient construction: small-scale laboratory
Engineering philosophy and	Public perception of engineering: public interaction and field survey
Engineering trends, implications, and consequences	Engineering report card: state of infrastructure in local community

Engineering resources	Library workshop: technical information literacy and engineering resources
Engineering design process	Projects: selection, design, and optimization of engineering projects
Engineering communication	Drawings: engineering graphic design Documentation and presentation: reports, slides, posters, and oral presentations Calculations: data management and analysis using spreadsheets
Engineering evaluations	Decision making: benefit-cost ratio
Sustainability and resilience	Final presentations and reports

The general purpose of this course is to provide orientation to various aspects of engineering, including engineering practice, communication, and design. These modules will guide students throughout the course to gain required knowledge and confidence for teaching engineering in grades K-6. The sequence of modules is oriented to fit an extended situational teaching cycle: guide-coach-support-delegate as shown in Figure 1 and Figure 2 (Tehrani, 2011) <sup>32</sup>. Extended situational teaching (Figure 2) is a recursive variation of original situational leadership theory applied to teaching (Figure 1). In the extended situational-teaching model, the Engineering Literacy course follows earlier courses in mathematics and science. Therefore, most students have already shown an interest in STEM and their willingness to continue the STEM path. In that regard, the engineering course is intended to complete the cycle and enable them to act on their knowledge and skills for training future generations of engineers. Figure 2 shows this process as T'' cycle follows T and T' cycles, where T, T', and T'' indicate sequences of the modules. However, students may not be either knowledgeable or confident about the engineering component of STEM in the beginning of this new course. Thus, renewal of their motivation in engineering is necessary (Figure 1). This can be done via discussions on the state of engineering in society, current needs, and future expectations (T1). Then, students will be ready to absorb information and knowledge on engineering practice and methods (T2). Toward the middle of the semester, students would be fully engaged in a term-project as their personal hands-on-experience (T3). This phase prepares them for the last quarter of the situational teaching and would complete the cycle (T4).

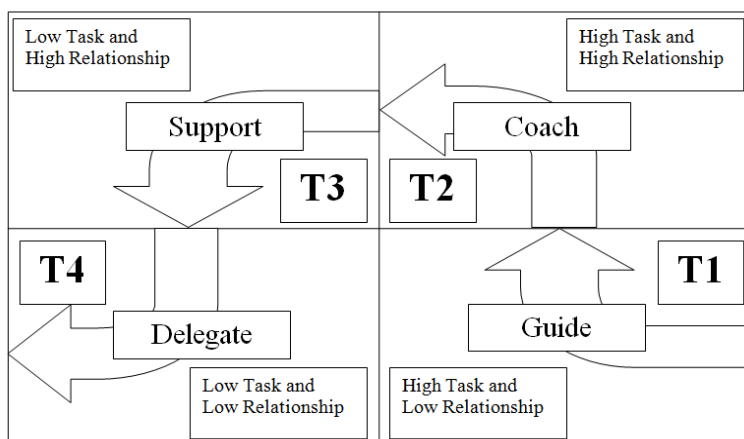

Figure 1. Situational leadership, after Hersey, et al. (1982) <sup>13</sup>

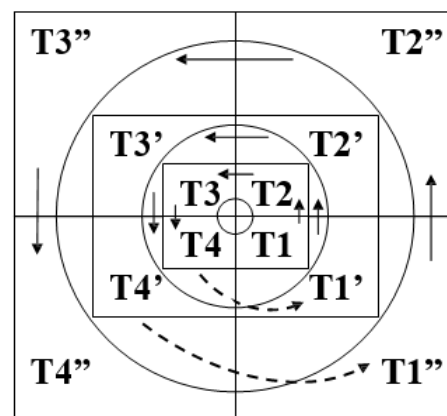

Figure 2. Extended situational teaching after Tehrani (2011) <sup>32</sup>.

The first module, Engineering Practice, aims to motivate students and reinforce their interest in this course by providing basic introductory reviews on history, trends, implications, and consequences of engineering. The historical review is an important component of this module as it contains briefings on engineers and their work, which can be narrated as stories for elementary students. Further, the significance of the course is emphasized through discussions on how engineering impacts society as well as individuals. This module provides an opportunity for students to learn about current issues of their society, e.g., America's infrastructure, public awareness of engineering, engineering education in K-12, etc. Moreover, assignments within this module allow students to gather information on these issues through surveying small communities, observing engineering works, and studying historical records. A brief review of engineering trends, implications, and consequences would familiarize students with the significance of engineering as well as future opportunities in this field.

Another topic of interest in the first module is engineering philosophy, in which students learn about the philosophical basis of engineering methods that form engineering judgment and the approach of engineers to problem solving. This topic is also linked to historical reviews of engineering and philosophy. A parallel topic on the psychology of engineers would open discussions on characteristics and qualifications of engineers. This topic is particularly important for teachers who plan to guide and train future generations of engineers, as early as K-6 grades.

Engineering Communication is the second module of the course and prepares students to think and process information like an engineer. This module is a companion to the general education curriculum on information literacy, oral communication, and writing. Students learn how to research, document, and present engineering information. Further, workshops and lab sessions include hands-on experiences on engineering drawings and spreadsheet calculations. Students are encouraged in their assignments to apply these skills in the development of lab reports, posters, and slide presentations.

The engineering design component covers a wide range of activities on project selection, design, and delivery. Students use outcomes of previous modules to identify needs, evaluate alternatives, and design solutions to the given problem as the term project. In this module, they will also learn about concepts of sustainability and resilience to deliver context-sensitive solutions. Examples may include balsa wood structures, wind turbines, etc. Students would be able to use this experience as a general guide to design their own experiments for K-6<sup>th</sup> graders.

*Course outcomes.* Table 2 contains learning outcomes for the Engineering Literacy course. These outcomes are derived from sample program outcomes for Engineering and for Liberal Studies majors. Table 3 and Table 5 present the mapping of course outcomes to these referenced outcomes. There are numerous common desired outcomes, such as critical thinking, communication, and life-long learning. These common outcomes are emphasized in the course to highlight the interaction between these two seemingly disparate fields – engineering and liberal studies. Students learn how engineers are expected to work within technical, economic, social, and political constraints. Further, students learn to appreciate the significance and impact of engineering projects and products on contemporary society.

Table 2. Course learning outcomes.

(1) Apply knowledge of the humanities and social sciences to engineering literacy.
(2) Design an experiment or plan a creative endeavor to explain the impact of engineering solutions on the economy, environment, political landscape, and society.
(3) Identify alternatives and options for an engineering system to meet desired needs within such realistic constraints as technical, economic, environmental, social, political, ethical, health and safety, manufacturability, constructability, and sustainability.
(4) Develop the ability to reason critically so as to form intelligent opinions, make good decisions, and determine the best course of action.
(5) Apply the principles of sustainability to the design of traditional and emergent engineering systems.
(6) Function effectively as a member of multidisciplinary, diverse, and multicultural teams, and apply leadership principles to direct efforts of a small, homogeneous group.
(7) Communicate effectively under time and environmental pressures.
(8) Describe the engineering design process and the impact of historical and contemporary issues on the identification, formulation, and solution of engineering problems.
(9) Understand the need for teachers to engage in life-long learning to further their education in engineering literacy.
(10) Know how to access and use a variety of engineering information sources.
(11) Develop solutions to well-defined project management problems.

Other relevant engineering outcomes (Table 3) include the ability to design, plan, and manage creative endeavors with respect to principles of context-sensitive solutions. These outcomes were derived from characteristics and criteria of engineering programs at the time of course development. Further, these outcomes are revised to shift the focus from application of mathematics and science to the qualitative evaluation of projects with respect to the humanities and social sciences. This course, by design, will not address all engineering outcomes. Excluded outcomes are those linked to pre-requisites in higher level mathematics, science, and engineering, courses which are not typically taken by Liberal Studies majors.

These course outcomes are explicitly aligned with the three dimensions of the Next Generation Science Standards (NGSS): Science and Engineering Practices, Crosscutting Concepts, and Disciplinary Core Ideas, as outlined by NRC (2012)<sup>26</sup>. Throughout the course, the students will actively engage in key science and engineering practices, such as defining problems and designing solutions, constructing explanations, and arguing from evidence. Crosscutting concepts, such as cause and effect, structure and function, and stability and change, can be used as themes that carry over between topics and projects in the course. The NGSS disciplinary core ideas will be addressed in the course as the students actively engage in the engineering design process (ETS1. Engineering Design) and explore interactions among engineering, society, economics, the environment, and other fields of knowledge (ETS2. Links among Engineering, Technology, Science and Society in NRC, 2012)<sup>26</sup>. The Standards for Mathematical Practice from the Common Core State Standards (CCSS) are also incorporated into the course. These practices (e.g. make sense of problems and persevere in solving them; attend to precision; use appropriate tools strategically) are congruent with and complement the NGSS Science and Engineering Practices<sup>8</sup>. Since the students enrolled in the course are primarily preservice teachers, instructors will make explicit connections to NGSS and CCSS.

Table 3. Mapping course learning outcomes to engineering outcomes (after ASCE, 2008) <sup>4</sup>

Engineering Outcomes (after ABET, 2010) <sup>2</sup>	Civil Engineering Outcomes (after ASCE, 2008) <sup>4</sup>	Course Outcomes
(a) Mathematics, science, engineering	1. Mathematics 2. Natural sciences 3. Materials science 6. Mechanics 14. Breadth in civil engineering areas 15. Technical specialization	N/A
	3. Humanities 4. Social sciences	(1)
(b) Experiments	7. Experiments	(2)
(c) Design	9. Design 10. Sustainability 12. Risk / uncertainty	(3), (4), (5)
(d) Multidisciplinary teams	21. Teamwork 20. Leadership 22. Attitudes	(6)
(e) Engineering problems	8. Problem recognition and solving	N/A
(f) Professional and ethical responsibility	24. Professional and ethical responsibility	N/A
(g) Communication	16. Communication	(7)
(h) Impact of engineering	11. Contemporary issues and historical perspectives 19. Globalization	(8)
(i) Lifelong learning	23. Lifelong learning	(9)
(j) Contemporary issues	11. Contemporary issues and historical perspectives 19. Globalization	(8)
(k) Engineering tools	8. Problem recognition and solving	(10)
	13. Project management	(11)
	17. Public policy 18. Business and public administration	N/A

Table 4. Mapping course learning outcomes to NGSS (After NRC, 2012) <sup>26</sup>

Course Outcomes	Science and Engineering Practices	Cross-cutting concepts	Disciplinary Core Ideas*
(1)			ETS2
(2)	(3) Plan and carry out an investigation; (6) Construct explanations; (7) Argue from evidence; (8) Obtain, evaluate and communicate information	(1) Patterns; (2) Cause and effect; (6) Structure and function	ETS1
(3)	(1) Define problems; (3) Plan and carry out investigations; (6) Construct explanations and design solutions; (8) Obtain, evaluate and communicate information	(4) Systems and systems models; (6) Structure and function; (7) Stability and change	ETS1, ETS2

(4)	(7) Argue from evidence; (8) Obtain, evaluate and communicate information	(2) Cause and effect	
(5).	(6) Design solutions	(4) Systems and systems models; (6) Structure and function; (7) Stability and change	ETS1
(6)	(3) Plan and carry out investigations; (8) Communicate information		
(7)	(8) Obtain, evaluate and communicate information		
(8)		(3) Scale, proportion, and quantity; (7) Stability and change	ETS2
(9)	(1) Ask questions and define problems		ETS2
(10)	(8) Obtain, evaluate and communicate information		
(11).	(1) Define problems; (6) Design solutions		ETS1
* ETS1: Engineering Design; ETS2: Links among engineering, technology, science & society			

Selected Liberal Studies outcomes (Table 5) cover the areas of information literacy, interpersonal skills, and the significance of art and literature in social values. The Engineering Literacy course is expected to address these outcomes as part of its integration in Liberal Studies program.

Table 5. Mapping course learning outcomes to liberal studies outcomes (After OSU, 2014) <sup>27</sup>

Liberal Studies Outcomes	Course Outcomes
1. Manage information: Apply knowledge to specific problems or tasks	(1)
2. Design and Plan: Identify alternatives and options	(3)
3. Research/Investigate: Describe a process, object or event without factual errors	(2), (8), (10)
4. Communicate	(7)
5. Manage Interpersonal Relationships	(6)
6. Think Critically	(4)
7. Manage and Administer	(6), (11)
8. Apply Values: Appreciate the contributions of art, literature, science and technology to contemporary society	(2), (5)
9. Develop a Successful Career and Personal Life: Develop ongoing motivational growth and life-long learning goals	(9)

*Course assessment.* The assessment components of this course are linked to the hybrid nature of the course, including lecture and laboratory sessions. As students experience development of their project using engineering tools and methods, they are expected to learn how an engineering project develops from inception to deployment of results. Learning from historical perspectives and contemporary issues will enable them to identify alternatives to meet desired goals. Further,

students will employ learned skills on information literacy, critical reasoning, and communication to perform data mining, select the best course of action based on data analysis, and present the results. Students will continue to work in teams to practice their leadership, management, and interpersonal skills. The term-project presentations include oral, written, quantitative, and graphical communications. Thus, the hands-on experience involvement in the term-project facilitates assessment of multiple learning outcomes. Supplemental assessments are also incorporated in this course to monitor and observe student performance throughout the semester. These assessment components include conventional homework, quizzes, and exams, as well as online and in-class discussions. These discussions allow students to engage in critical reasoning using contemporary issues related to engineering, humanity, and other relevant topics.

Table 6. Mapping course learning outcomes to course topics

Course Topic	Course Learning Outcomes	
	Essential	Basic
History of engineering	(1)	(8), (9)
Engineering philosophy and psychology	(1), (4)	(6), (7)
Engineering trends, implications, and consequences	(1), (9)	(3), (5), (8)
Engineering resources	(10)	(9)
Engineering design process	(2), (3), (5)	(6), (8), (10), (11)
Engineering communication	(6), (7), (8)	(10)
Engineering evaluations	(3), (4), (11)	(6), (7), (8)
Sustainability and resilience	(5), (8)	(1), (2), (3)

## Results and Conclusions

*Measures.* An evaluation of awareness of engineering was performed through survey and short answer questions that were given to a variety of respondents. A survey that asked both demographic and questions related to general awareness of engineering was utilized for all groups that participated. A section of this survey was specifically designed to be given to those students enrolled in the Engineering Literacy course who plan to be teachers in grades K-6 or middle school. The second measure of engineering awareness was a movie clip viewed in a classroom setting by a select group of student respondents. Students participating in that measure were asked to write tag(s) for the clip. Their tags were then evaluated for technical or engineering thought process and terminology. The written survey consisted of four sections; personal information, course characteristics, plans and expectations, and engineering literacy (Table 7).

The personal information section offered checkboxes to standardize student answers. The selection options provided for 'Year in School' were Freshman, Sophomore, Junior, Senior, Graduate, and Other. Grade Point Average (GPA) was broken down into multiple ranges that could be selected. The categories offered were; Below 2.0, 2.0-2.49, 2.5-2.99, 3.0 – 3.49, and 3.5+. Students also could select that their GPA was unknown. The expected grade in this class question referred to the course in which they were taking the survey. Three courses were used in this evaluation; Electric Circuits, Civil Engineering Project Design, and Engineering Literacy. The course characteristics section was designed to evaluate their confidence level in enrolling in

the course and initial interest in the course. Students were given selection options of; very low, low, average, high, and very high.

Table 7. Survey questions.

Section	Question
Personal Information	Year in School
	Current GPA
	Expected Grade in this Class
Course Characteristics	Subject interest before taking the course
	Knowledge relevant to the subject before taking the course
Plans and Expectations	Major
	If Liberal Studies, Are you planning for STEM concentration?
	Motivation for taking this course
	Are you currently teaching? If so, in what capacity?
	What grade level to you interact with?
	What grade(s) do you think you want to teach?
	What subject(s) do you think you want to teach?
	What teaching credentials/authorizations do you hope to eventually receive?
Engineering Literacy	Do you know an engineer up close?
	What is an engineer?
	What is required to become an engineer?
	Where do engineers work?
	What are some responsibilities of engineers?
	What things must be considered before installing a traffic light?

The plans and expectations section of the awareness survey was only given to the students enrolled in the Engineering Literacy course. The questions in this section match other surveys given in complimentary classes in the liberal studies STEM concentration. Students could respond both with checkboxes of pre-determined responses or with write-in answers. Multiple responses were accepted for the question of motivation for taking the class and offered selections were: fulfills STEM concentration, fee scholarship provided to students taking STEM concentration, future career opportunities, to better teaching ability, used to be engineering major, and none.

Engineering literacy is evaluating the awareness of students with regards to engineers, engineering, and the profession. All responses were write-in except for the question of “Do you know an engineer up close?”. Options for response to that question were standardized to family, Friend, neighbor, co-worker or no. A variation of the original engineering awareness survey was created for the target group of K-6 students. The basic engineering literacy questions of the survey were preserved but worded in a manner appropriate for the average first grade student. All responses for the K-6 engineering awareness survey were short answer. The questions in this survey are listed in Table 8. Although personal information were not asked from students, the survey administrators were asked to record that information for the K-6 students.



Table 8. Survey questions for grades K-6.

Do you know an engineer? Who?
What do engineers do?
Where do they work?
Draw an engineer.
Why should we have traffic lights?

The movie clip for the second measure of engineering awareness was a short compilation from a documentary titled “Baraka” that focuses on humanity <sup>19</sup>. The clip consists of a variety of cinematographic scenes paired to music; there is no dialog. Additionally, the portion of the movie was deliberately selected to not relate overtly to engineering or technology. This was shown to a smaller population of respondents in a group setting. Students were asked to give their first impressions of the movie, specifically non-edited content that came to mind while viewing the clip. Tags for the clip were written by the students following the viewing. Various populations of respondents participated in the measure of engineering awareness. Table 9 summarizes the respondents that were surveyed and the tool that they participated in.

Table 9. Surveyed respondents

Respondents	Awareness Survey without Plans	Awareness Survey + Plans Section	Impression of Movie Clip
Fresno State Liberal Studies Students	X	X	X
Community College Engineering Students	X		
Fresno State Civil Engineering Students with Senior Standing	X		X
K-6 Students	X		

The respondent groups varied in size and background. The Fresno State Liberal Studies students surveyed are enrolled in Engineering Literacy. Fresno State Civil Engineering students are enrolled in a senior-level civil-engineering project-design-course. The community college students are enrolled in electric circuits, but have intentions in majoring in various disciplines of engineering. Student respondents in this pool intend to transfer to a four-year institution to major in civil engineering, computer engineering, electrical engineering, chemical engineering, and mechanical engineering. The elementary school students were surveyed by the liberal studies students enrolled in Engineering Literacy as their first homework assignment. Each engineering literacy student interviewed at least three K-6 students.

Surveys and movie clip responses were collected during the first and second week of the semester. These serve as baseline information with regards to engineering literacy prior to taking the engineering literacy course. A follow-up measure of the tagging of the movie clip was administered the third week of the semester in the engineering literacy course. A different clip from the initial documentary related to humanity was shown to students. This measure was administered the week immediately following the first lecture. The content of the lecture was the history of engineering, engineering philosophy, and engineering judgment. Homework performed during the week following the first lecture consisted of viewing an episode of a television program that is directly related to technology and engineering. Students were asked to

comment on the program in an on-line discussion thread and also to review and refute or support their peer's comments. Surveying K-6 students was another homework item performed in the engineering literacy course prior to the follow-up measure of viewing another documentary clip and tagging its content.

Students in the Engineering Literacy course have a wide variety of levels of previous exposure to engineering. Of the 12 students surveyed at the beginning of the class period on the first day of the course, seven had a family member, a friend, or a co-worker who was an engineer. Five of the Engineering Literacy students responded that they did not know an engineer. Of the seven respondents that knew an engineer, four have an engineer in their family. The tags created by the Engineering Literacy students during the first week of class were evaluated for references to engineering and technology. Greater awareness of engineering will translate to a tag of the movie clip that includes terms that reference engineering or technology.

Four of the eleven Engineering Literacy student responses were determined to be associated with engineering and technology. The terms that were considered related to engineering and technology are in the bulleted list below.

- Modernization (airplane)
- Structures, building
- Engineers

Responses to the follow up measure of tagging the movie clip were also evaluated. Tagging of the second clip of the initial documentary was performed by the Engineering Literacy students during the second class period. During the second tagging exercise, students were asked to report on subject matter viewed in the documentary clip that meet two different qualifications; (a) problems caused by engineering and (b) solutions provided by engineering. With these instructions influencing their responses, 9 out of 11 respondents used terminology associated with engineering and technology. From the initial tagging exercise, 36% of the students responded with technical or engineering related terminology. Given direct instructions to report on the effects of engineering viewed in the clip the percent of students responding with technical or engineering terms rose to 82%. Evaluation of the Engineering Literacy assignment to survey K-6 students with regards to their engineering awareness led to the assessment of 31 responses. Not all the grade levels of the students were recorded. Those that were recorded ranged from 2<sup>nd</sup> grade to 6<sup>th</sup> grade. Only 7 of the K-6 students surveyed responded that they knew an engineer. The most frequent responses to the survey questions of what an engineer does and where they work are compiled in Table 10. Popular responses from K-6 students referenced the engineer as a mechanic or related to working with a train, similar to results reported by Oware (2008) 30. This perception of an engineer being a mechanic that works on cars is shared by K-6 students who personally know an engineer as well as those that do not. Students that reported knowing an engineer did not give any responses that involved working on/or driving trains.

Table 10. K-6 Responses to engineering awareness survey

What do engineers do?	Know an Engineer	Do not Know an Engineer	Unknown	Total
Build things	1	3	3	7
Work on cars	2	3	1	6

Fix things	2	2	2	6
Work on trains	0	3	2	5
Work on engines	1	3	0	4
<b>Where do they work?</b>	Know an Engineer	Do not Know an Engineer	Unknown	Total
Car shops/repair shops	3	5	1	9
On a train/train tracks	0	3	1	4
In buildings/office	0	2	0	2

*Implications for teacher education.* With the increased emphasis on STEM education (President's Council of Advisors on Science and Technology, 2012), it is incumbent on teacher education programs to consider how preservice teachers, particularly at the elementary level, understand the fundamental aspects of engineering<sup>29</sup>. While the NGSS provides some impetus for this focus, traditional teacher education programs of study are inadequate for the task. It is necessary for faculty in schools of engineering to collaborate with teacher education faculty, in order to provide the subject area expertise that can result in the development of pedagogical content knowledge (Shulman, 1986) relevant to engineering. The unique course described in this paper serves as the beginning, not the end of such a collaboration. Continued work to refine the course, based on meaningful inquiry into preservice teacher learning of engineering concepts coupled with active learning pedagogy, will help to realize the vision called for in the PCAST report.

## Bibliography

1. AAAS (American Association for the Advancement of Science). 2000. *Designs for Science Literacy*. New York: Oxford University Press.
2. ABET (Accreditation Board for Engineering and Technology). 2010. *Criteria for Accrediting Engineering Programs*. Baltimore, MD: ABET. ([www.abet.org](http://www.abet.org)).
3. Anthony, H.G, D. Garber, and G. Johnson. 2007. Preparation of Teachers for a Rapidly Changing Technological World: Engineering in Teacher Education. *2007 IEEE Meeting the Growing Demand for Engineers and Their Educators 2010-2020 International Summit*. 50 Papers: 1-14.
4. ASCE (American Society of Civil Engineers). 2008. *Civil Engineering Body of Knowledge for the 21<sup>st</sup> Century*. Second Edition. Reston, VA: ASCE. ([www.asce.org](http://www.asce.org))
5. Brady M., C.F. Bohlin, F. Nelson, and F. Tehrani. 2013. STEM for Future Elementary Teachers. *STEM Learning in Action Conference*, Fresno, CA, May 2013.
6. Cai, H., and Y. Li. 2010. The Analysis and Research on Young Teachers' Engineering Continuing Education in the Local Engineering Colleges. *Educational and Information Technology (ICEIT)*, 2010 International Conference no. 2: V2-332-V2-335.
7. Capobianco, B.M., H.A Diefes-Dux, I. Mena, and J. Weller. 2011. What is an Engineer? Implications of Elementary School Student Conceptions for Engineering Education. *Journal of Engineering Education*. 100, no. 2: 304-328.
8. Common Core State Standards Initiative. 2012. Standards for Mathematical Practice. Washington, DC: Common Core State Standards. ([www.corestandards.org/Math/Practice](http://www.corestandards.org/Math/Practice)).
9. Culver, D.E. 2012. *A Qualitative Assessment of Preservice Elementary Teachers' Formative Perceptions Regarding Engineering and K-12 Engineering Education*. n.p.: ProQuest, UMI Dissertations Publishing.
10. Duncan, D., H. Diefes-Dux, and M. Gentry. 2011. Professional Development Through Engineering Academies: An Examination of Elementary Teachers' Recognition and Understanding of Engineering. *Journal of Engineering Education*. 100, no. 3: 520-539.
11. Flynn, A.M., M.H. Naraghi, N. Austin, S. Helak, and J. Manzer. 2006. Teaching Teachers to Teach Green Engineering. *Journal of STEM Education: Innovations and Research*. 7, no. 3/4: 13.

12. Gorham, D., P.B. Newberry, and T.A. Bickart. 2003. Engineering Accreditation and Standards for Technological Literacy. *Journal of Engineering Education*. 92, no. 1: 95.
13. Hersey, P., A.L. Angelini, and S. Carakushansky. 1982. The Impact of Situational Leadership and Classroom Structure on Learning Effectiveness. *Group & Organization Studies*. 7 (2), pp. 216-224.
14. Hill, R.B. 2006. New Perspectives: Technology Teacher Education and Engineering Design. *Journal of Industrial Teacher Education*. 43, no. 3: 45-63.
15. Hynes, M. 2012. Middle-school Teachers' Understanding and Teaching of the Engineering Design Process: A Look at Subject Matter and Pedagogical Content Knowledge. *International Journal of Technology and Design Education*. 22, no. 3: 345-360.
16. Klein, J.D. and R. Balmer. 2007. Engineering, Liberal Arts, and Technological Literacy in Higher Education. *IEEE Technology and Society Magazine*. 26, no. 4: 23-28.
17. Locke, E. 2009. Proposed Model for a Streamlined, Cohesive, and Optimized K-12 STEM Curriculum with a Focus on Engineering. *Journal of Technology Studies*. 35, no. 2: 23-35.
18. Ma, E.Z., E.W. Lo, and M. Chan. 2012. An Experimental Study of Engineering-Science-Mathematics Approach in Elementary Engineering and Science Education. *Proceedings of IEEE International Conference on Teaching, Assessment, and Learning for Engineering (TALE) 2012*. H4A-6-H4A-11.
19. Magidson, M. 2001. *Baraka*, Chapter 9. Destruction. DVD. Directed by Ron Fricke, original release 1992. Culver City, CA: Magidson Films, Inc.
20. Mann, E., M. Strutz, S. Yoon, D. Duncan, and R. Mann. 2011. Integrating Engineering into K-6 Curriculum: Developing Talent in the STEM Disciplines. *Journal of Advanced Academics*. 22, no. 4: 639-658.
21. NAE (National Academy of Engineering). 2002. *Raising Public Awareness of Engineering*. Ed. L.A. Davis and R.D. Gibbin. Washington, D.C.: National Academies Press.
22. NAE (National Academy of Engineering). 2006. *Tech Tally: Approaches to Assessing Technological Literacy*. Ed. E. Garmire and G. Pearson. Washington, DC: National Academies Press.
23. Naimpally, A.V., H. Ramachandran, and C. Smith. 2012. *Lifelong Learning for Engineers and Scientists in the Information Age*. London: Elsevier.
24. NEA (National Academy of Engineering). 2002. *Technically Speaking: Why All Americans Need to Know More About Technology*. Ed. G. Pearson and A.T. Young. Washington, D.C.: National Academy Press.
25. Nelson, F.L., C.F. Bohlin, M. Brady, D.C. Williams, K. Runde, N. Papavasiliou, and F. Tehrani. 2013. Growing STEM Learning Experiences for Future Elementary Teachers. *Science and Mathematics Teacher Imperative 2013 National Conference*. St. Louis, Missouri, June 2013.
26. National Research Council. 2012. *A Framework for K-12 Science Education: Practices, Crosscutting Concepts, and Core Ideas*. Washington, DC: The National Academic Press.
27. Oregon State University. 2014. Liberal Studies Learning Outcomes, Corvallis, OR: OSU. ([oregonstate.edu/cla/liberal\\_studies/learning-outcomes](http://oregonstate.edu/cla/liberal_studies/learning-outcomes)).
28. Oware, E.A. 2008. *Examining Elementary Students' Perceptions of Engineers*. n.p.: ProQuest, UMI Dissertations Publishing.
29. President's Council of Advisors on Science and Technology. 2012. *Engage to Excel: Producing One Million Additional College Graduates with Degrees in Science, Technology, Engineering, and Mathematics*. Washington, DC: Office of Science and Technology Policy. ([www.whitehouse.gov/ostp/pcast](http://www.whitehouse.gov/ostp/pcast))
30. Robinson, M., and B. Kenny. 2003. Engineering Literacy in High School Students. *Bulletin of Science, Technology & Society*. 23, no. 2: 95-101.
31. Shulman, L. 1986. Those Who Understand; Knowledge Growth in Teaching. *Educational Researcher*. 15. no. 2: 4-14.
32. Tehrani, F.M. 2011. Implementing Situational Leadership in Engineering Classrooms. *Proceedings of the Pacific Southwest Section of the American Society for Engineering Education*, California State University, Fresno. 114-124.
33. Tehrani, F.M., F.L. Nelson, N.K. Papavasiliou, C.F. Bohlin, and M. Brady. 2014. Integrating STEM into K-6 Teacher Education: A Multi-Disciplinary Approach to Faculty Collaboration. *PSW American Society for Engineering Education*, California State University, Long Beach, CA, April 2014.

## **Leveraging Scholarships to Advance Student Success**

Jared Tuberty, Thalia Anagnos, and Emily Allen  
San José State University/ California State University, Los Angeles

### **Abstract**

As college costs rise, students and their families continually look for ways to pay for an undergraduate education. Increased financial pressures have forced some students to work additional hours in part-time or even full-time employment. As a result, time to degree can be extended as students tackle fewer units per term or as they repeat courses, struggling to balance work and school. Scholarship funding is one mechanism to help support students, but providing financial relief is not enough. Scholarship recipients face many of the same challenges as all students, in that some find themselves struggling as they transition to college or shift from community college to a four-year institution. Some scholarship students find it difficult to ask for help, assuming that because they have been awarded merit scholarships, they should be able to manage all aspects of college on their own. In the face of these challenges, the College of Engineering at San José State University has developed a robust scholarship program. It moves beyond simply awarding money to help students pay their education costs by providing a broader student support program. Through student performance tracking, academic support resources, and professional development programming, along with program guidance and support from a range of faculty and staff members, scholarship students are retained at higher rates and earn their degrees in fewer semesters than the college average. This paper describes our integrated scholarship program involving multiple cohorts of students funded through a variety of financial streams including individual and corporate donors, and a National Science Foundation S-STEM grant. From the centralized scholarship application and selection process to the tracking and mentoring processes, we will show how institutionalizing the process has allowed us to attract additional donors, better support our scholarship students to graduation, and assist our students in moving into leadership positions.

### **The Need for Scholarships and Financial Support**

The cost of college in the United States continues to rise. In-state tuition and fees at public four-year institutions increased 2.9% for the 2013-2014 academic year; a smaller rise compared to the 4.5% and 8.5% increases of the previous years respectively. For the California State University system, tuition for a full-time undergraduate increased from just under \$1,500 during the 2001-2002 academic year to over \$5,400 as of fall 2011. While this figure remains affordable in the context of national educational costs, the extreme increase in a short period of time has been a challenge for families who did not expect or plan for such rises. As costs have increased, many students find themselves needing to work more hours to pay for school. In addition, for some students reduced units to accommodate work commitments have in turn resulted in increased time to degree thereby extending the higher tuition and fees. While some studies have suggested that working part-time while in school correlates with higher academic performance and increased likelihood of degree completion, the literature is not consistent. Additional research has shown connections between student financial aid and retention along with casual evidence linking financial aid and grade point average.

Generally evidence indicates that providing scholarship resources to students can result in students needing to work fewer hours, allowing them more time to devote to academics and co- and extra-curricular activities. It can also reduce student loan debt and reduce the burden students carry into the workforce. The goal in the San José State University (SJSU) College of Engineering is to package the scholarship dollars with additional human resources and programming to ensure that students thrive and gain skills and attitudes to become future leaders.

### **Institutional Background**

SJSU is a public university located in the center of San José, California and in the heart of Silicon Valley. Founded in 1857, SJSU is the oldest public institution of higher education on the West Coast. One of 23 campuses of the California State University (CSU) System, it has matured into a comprehensive university offering rigorous course work and research opportunities to over 31,000 undergraduate and graduate students in seven colleges. SJSU powers Silicon Valley by educating the teachers, nurses, engineers, business leaders and others who give the region its core strength and drive its future. The university is immensely proud of the accomplishments of its more than 225,000 alumni, two-thirds of whom live and work in the Bay Area.

In fall 2013, the Charles W. Davidson College of Engineering enrolled nearly 6,000 students, including over 3,900 undergraduate students in 13 Bachelor's degree programs in engineering, aviation, and technology, eight of which are ABET accredited. SJSU's engineering programs consistently receive top recognition among public Master's-level institutions by U.S. News and World Report, with the 2014 edition of "Best Colleges" ranking the College of Engineering as second in the nation in this category. SJSU is the number one producer of engineers and technical talent for Silicon Valley. Approximately half of SJSU students report they are the first in their family to go to college. Over 66 percent of full-time undergraduates at the institution receive some kind of need-based financial aid. The College of Engineering student body reflects the overall diversity of the University. The ethnic breakdown of undergraduates in the college includes 19% Hispanic, 3% African American, 40% Asian, 22% White, 6% International students, and approximately 1% American Indian or Pacific Islander. Women are underrepresented in the College, making up 14% of undergraduates. The majority of new students each fall in the College are first-time first-year students though a substantial number, approximately 40% of the new students, enroll as upper-division transfer students. These transfer students come primarily from the extensive California Community College system. The University formed a formal retention and graduation initiative in 2009 and has continued to examine policies, procedures, and support structures that can assist in helping students succeed in their chosen degree programs and graduate with bachelor's degrees. The College of Engineering has followed this initiative with its own programs aimed at increasing 6-year graduation rates and closing the achievement gap among underrepresented minorities. The College of Engineering scholarship programs have evolved to further support these retention and graduation initiatives in addition to attracting high achieving students to SJSU.

### **Our Scholarship Programs**

The SJSU College of Engineering has two well-established and carefully managed engineering scholarship programs, with overlapping management teams, tracking processes and goals. The Silicon Valley Engineering Scholarships (SVES) are funded by corporate partners and private

donors. These scholarships are offered primarily to incoming first-year students, providing up to four years of student funding at \$5,000 per year. Most SVES scholars demonstrate financial need, but it is not a requirement for all of these donor-designated scholarships. For the past several years we have selected between 10 and 12 new scholars each fall, with the SVES scholar group averaging 35 students. The Engineering Leadership Pathway Scholarships (ELPS), funded by a National Science Foundation S-STEM (Scholarships in Science, Technology, Engineering and Mathematics) grant, are offered primarily to incoming transfer students in addition to a select group of junior-level native students, providing up to three years of funding at \$5,000 per year. ELPS scholars must demonstrate financial need as well as high potential for academic success. During the five-year grant, we will have supported 46 students. The last new cohort of scholars was awarded in fall 13.

### **Application Process**

The vast majority of scholars are selected through a unified application process that occurs in conjunction with the fall admissions cycle. In February, all provisional College of Engineering admits (both frosh and transfer applicants) receive e-mail and paper mail notification about our College-specific scholarship programs and instructions on how to apply. Interested students complete an on-line application through the College's website gathering basic demographic and academic information as well as a free response essay to a general prompt focused on leadership and their potential success as an engineering student at SJSU. This application window closes in mid-March. Continuing students in the College are also able to apply for scholarship consideration during this window.

Over the subsequent several weeks, the applicant pool is narrowed down to a group of semi-finalists representing all of the College's degree programs. These semi-finalists are then notified and invited to attend an in-person interview. These interviews conveniently take place in mid-April during SJSU's Admitted Spartan Day, a campus-wide event where all newly admitted students have an opportunity to visit campus and learn more about what the University offers. This day includes an all-hands-on-deck College of Engineering Open House where we showcase our programs and opportunities and allow admitted students the opportunity to connect and network with faculty, staff, and students. The semi-finalists are interviewed by faculty and staff at the Open House and are escorted to and from the interviews by current scholars. Based on the initial application information along with the feedback and input from the interviews, the College scholarship committee makes final award decisions. This is a somewhat complex endeavor as at this point scholars are matched with specific funding sources. All attempts are made to balance the incoming cohorts of scholars among our majors and making sure to follow any specific donor criteria that may be in place. All awardees are notified prior to May 1, SJSU's "Intent to Enroll" date, so that students can make decisions accordingly and so that our scholarships have the added potential to influence these outstanding students to enroll at our institution. While some students will have already decided to attend prior to the awarding of the scholarship, we know others have finalized their choice based on the additional award.

While we are not able to award scholarships to all of the semi-finalists, this process also gives us an additional pool of students should any of the awardees withdraw or if additional scholarship monies are secured, as we are constantly seeking out new sources of support. Additionally, many departments manage smaller scholarships and are able to offer them to semi-finalists as a

recruiting technique. Because we use one simple application, our process maximizes the number of opportunities for which students can be considered.

### **Scholar Programming and Activities**

Additional research has shown that a combination of financial support and academic support lead to higher retention rates than focusing on only one alone. While this may seem obvious, it is further evidence that simply providing financial aid to students is not sufficient to ensure retention and graduation; additional personal support is needed to maximize the impact of the investment. Many of the programs we develop directly or indirectly tie to high-impact educational practices shown to have true impact in student retention.

This frames our overall philosophy and support framework for our scholarship programs. We are investing financial resources in our students and we want to supplement that money with professional development along with academic and personal support. This provides opportunities for students to connect with not only faculty and staff, but also with each other. We have developed an internal infrastructure with responsibilities spread among various college staff, administrators, and faculty. Our scholars interface closely with four individuals within the college who guide the scholarship programs: the Associate Dean, the Executive Director of Engineering Student Success Programs, the Student Program Coordinator, and the faculty member serving as the Principal Investigator of the NSF grant covering the ELPS program.

The formal goals of our programs include the following:

- Effectively support students so that they graduate on time, with the technical background, performance record, motivation needed to pursue graduate degrees or enter the workforce.
- Create and institutionalize activities that promote and reinforce attitudes and skills essential to engineering and personal leadership through leadership development opportunities.
- Develop the scholarship recipients as a community of learners who support each other's individual and common goals

Much of our programming model centers on leadership. Leadership is not solely positional. We define leadership as the attitudes and skills that enable the engineer to have a vision beyond the technical solution, to articulate the big picture, and to bring others along in exploring and implementing that vision. Leadership also involves the development of an understanding of the complexities that face us as both American and global citizens. Through the ELPS program, we focus more intentionally on the development of a leadership plan. Students are encouraged to work with their ELPS faculty mentor to develop a plan to advance themselves in various leadership skills. We have supported this development using self-assessment with the MBTI (Myers-Briggs Type Indicator) questionnaire with followed by workshops with Career Center personnel, sharing of opportunities both on and off-campus with students and encouraging them to participate, one-on-one connections, and mentoring to help students assess and develop their skills.

One of the main goals of our programming is to connect students with each other. The SVES and ELPS cohorts gather periodically. For ELPS, these are regular events called Munch with the Mentors, at which the scholars have lunch or a late-afternoon snack with a group of five to six faculty mentors. ELPS scholars are matched up with one of the mentors, with each mentor



having four to five scholars assigned to him or her. It is our goal that the students not only get to know their mentors, but also the other students in their mentor group.

There are times that we bring all of our scholars together for programs. For the second year we have coordinated a Leadership Breakfast series that was first developed with our scholars as our target audience (and has since expanded to a program for a broader set of student leaders in the College). These breakfasts bring together 3-4 industry professionals who serve on a panel with 40-50 students in attendance. After an informal breakfast of conversation, the panel shares their perspective on various aspects of leadership as they relate to engineering and technology. The morning ends with additional time for networking and one-on-one or small group conversation. During the year we provide additional opportunities to our scholar cohorts, including Career Center workshops and presentations, often taking place shortly before job and internship fairs. Another popular activity has been various field trips to local sites. In the past two years scholars have visited multiple construction sites, including that of our own campus' Student Union expansion, the new span of the Bay Bridge, the new Levi's Stadium (the future home of the San Francisco 49ers football team), and the BART extension project into Milpitas and San Jose. Students see how engineers from multiple fields interact on major construction projects, and gain access to areas and information not open to the general public. We are working on extending the field trip program to local industry offices and fabrication facilities.

Our programming and interactions with scholars frequently encourage students to get more involved. This often means connecting with one or more of over 30 student organizations associated with the College of Engineering (or the dozens of other SJSU recognized groups). College organizations span from student chapters of professional societies tied to engineering disciplines (e.g., American Institute of Chemical Engineers and the American Society of Mechanical Engineers) to competition based groups such as our Spartan Racing team which builds and races the SAE formula one vehicle or the Concrete Canoe team. Multi-disciplinary groups including the Society of Women Engineers and the Black Alliance of Scientists and Engineers help build additional camaraderie and support among their members. Other groups, such as Engineers Without Borders, are active in designing solutions to real world problems and participating in service activities. We encourage our scholars to take on leadership roles and practice some of the skills they are developing through guiding group activities.

The College of Engineering also has an Engineering Ambassador Program that connects current students to K-12 outreach activities. As the regional affiliate of Project Lead The Way (PLTW), a program advancing engineering curricula in high schools and middle schools, SJSU supports PLTW teachers and students with opportunities to interact with our student ambassadors. Through this interaction our undergraduates promote engineering to the next generation while at the same time enhance their own leadership development. As part of our academic support component, we actively track our scholarship students each and every semester. Upon the release of semester grades, all scholars are reviewed to determine if they are maintaining appropriate performance (generally indicated by an overall gpa higher than with a major gpa of 2.7 and higher, along with good progress toward their intended degree). Students that do not meet this bar or others who appear to have dipped in their performance are contacted by one of the administrators involved in the scholar program. This proactive and intrusive advising involves conversations in person or on the phone to discuss the student's situation and how,

together, we can develop an improvement plan. Often it is in these conversations that students admit they have attempted to take on too much, or they had been afraid to ask for help. This also provides another contact point for the student with a faculty or staff member. Knowing that someone is not only watching, but also caring, has been a specific action our scholarship students have appreciated.

If necessary, the student may be placed on *scholarship probation* in which a specific standard is set for the following semester to maintain scholarship support. If poor academic performance continues, the student may be put on *scholarship suspension* until performance has improved or may be disqualified from the program with no further consideration for scholarship support. Occasionally this intervention may result in a student deciding that engineering is not for him or her, and additional advising is provided to help transition to a different major at the University. We fully support the student toward achieving their educational goals in terms of advising and student services, but due to the nature of the funding sources the scholarship support would end. To augment our own programming, we regularly publicize existing programming in other academic and student services divisions so that we are not squandering resources to duplicate what already is happening on campus. We refer students to the multitude of resources on campus such as the Counseling Center, Peer Connections (a tutoring and supplemental instruction resource), and Writing Center.

### **Gaining Additional Financial Support**

Having such a robust and well-managed scholarship program has allowed us to leverage additional support from a range of donors including corporate, individual donors, and family foundations. Being in the heart of Silicon Valley, SJSU and the College of Engineering have been fortunate to receive support from industry. We have designed the program so that instead of a company being matched with one or more “named” scholars, they have the opportunity to connect with all of our scholars. From an accounting perspective the donor gift will be dispersed to specific students, but in actuality the company is able to network with our entire cohort of scholars which can number over 60 during any one year. This has been a great recruiting tool for new industry sponsors. This has also been a bonus for our growing individual and foundation donors. While in the case of these donors there is the excitement and interest in supporting and getting to know an individual student, they see the power of a critical mass of students and our programming model to make their gift even more powerful. Donors regularly report the satisfaction of knowing they are part of a greater plan to support students achieving their educational goals.

In fall 2013, we entered a partnership with the National Action Council for Minorities in Engineering (NACME) and were awarded a Scholarship Block Grant. This will provide an additional pool of scholarships for the next three years with the potential for renewal. NACME scholars will be selected as part of our annual SVES/ELPS selection and will then join in with our regular activities while also benefiting from resources provided by NACME. Having a well-established program that promoted the on-going success and professional development of scholarship awardees matched well the intent of NACME, so a natural partnership formed. This has already led to further connections within the local community as NACME has connected the College of Engineering with several local organizations including the Greene Scholars Program, a local non-profit organization advancing science education programming for African-American

students in the Bay Area. This leads to another important aspect of maintaining a successful program, that of stewardship. As noted above, one of our major events is an annual Scholarship Luncheon that brings together our scholars and our donors. This event, held in spring semester, allows our scholars the opportunity to say thank you to our donors. The donors have the chance to meet with our students, and everyone sees how the program is bigger than any one individual student or donor. In addition to this luncheon, we coordinate additional thank you communications and other updates, particularly for the individual and family foundation donors so that there is a more personal connection to the support that is given and received.

### **Success Stories**

Before creating this support model 20% to 30% of scholars would not meet continued eligibility requirements and would lose their scholarship. However, since 2010 and the more intentional student support and advising directed to the scholars, that percentage has been lowered to near 10%. While even with additional advising and mentoring a small percentage of students are still disqualified from the scholarship program, these students generally continue on to earn a degree in engineering or in another major if the student determined that engineering was not an academic and career fit.

Data indicate that our students are finishing their degree in a more timely fashion than the rest of the SJSU engineering student population. While an incoming transfer student often takes three or more years to complete their degree post-transfer, the participants in our ELPS program finish sooner, putting their average closer to 2.5 years. The knowledge that their funding is limited, in most cases a frosh would be eligible for up to only 4 years and a transfer student up to 3 years, helps students plan their schedules accordingly and to plan ahead for additional semesters beyond their scholarship. Other instances of success are more anecdotal. Many of our scholarship program participants have gained the confidence to take advantage of additional opportunities and resources. Many scholars have been selected for College or University programs including our Global Technology Institute (a 2-3 week exposure to engineering and business in the Asia-Pacific region through travel and project work), and the Salzburg program where students attend a week-long global seminar in Austria and return to campus with a year-long commitment to further globalize SJSU.

Our scholars often become leaders in student organizations and conversely leaders in student organizations become new scholars. As we work with students to be more intentional about their professional development, leadership positions become more appealing and worthwhile for students to consider. The multiple events we hold allow the opportunity for students to network with faculty, staff, and industry professionals. Students have gained internships after first connecting with a company representative at our Scholarship Luncheon or one of our Leadership Breakfasts. There have also been successes for those looking toward graduate school as an option. Through our mentoring relationships, students have had the opportunity to collaborate with faculty on research projects. Our scholars have also been very successful in the competitive world of Research Experiences for Undergraduates (REUs).

While anecdotal, it seems that the increased opportunity for networking has resulted in students more willing to come to faculty or staff members with concerns or problems. One of our intended program outcomes was to provide access to people who could help, but the students still

need to ask for that support – and they are doing so. We have also seen personal growth in our scholars. Since our selection process values not only leadership experience, but also potential, some scholars may be shy, lacking confidence, or less accomplished in their communication skills. But after a time, they blossom into leaders who not only take advantage of resources but reach out to other students to bring them along. Their experiences as scholars also influence their career choices. One of our ELPS scholars was intentional about his job search as graduation neared. His exposure to leadership concepts within the program led him to apply to only those positions that involved a leadership development training program. He successfully achieved his goal and has been hired into a very competitive leadership development program at Cisco that includes three months of classwork internal to the company on leadership and business skills in addition to various certifications. This will be followed by nine months of on-the-job leadership training before moving into a position somewhere in the company. This scholar took our program to heart. We are developing a better process for staying connected with our College alumni, and we will specifically continue to follow our scholars to see where their careers go. This will allow us to better document the success of our scholarship program as well as develop a pool of alumni ready to give back to the scholar programs, particularly with their knowledge, skills, and abilities to share with our current students. Indeed, one student sent a check to the program only one year after graduation, indicating she wanted to provide another scholar with the opportunities she had.

### **Additional Outcomes**

Through the further development of our scholarship program, we have identified several additional outcomes that we did not initially anticipate.

- Those semi-finalists who were interviewed but not awarded scholarships felt a closer connection to the college when they arrived at SJSU since they met several faculty and staff members in the process.
- The scholarship cohorts became an avenue to pilot new programs or support tactics that could later be scaled up to the larger student population.
- The scholarship cohorts created an additional feedback loop to the College administration. Our scholars are more likely to respond to surveys or attend feedback sessions such as the regularly scheduled Pizza with the Dean program where the Dean leads an open conversation with students about the state of the college.

### **Challenges and Future Development**

We have identified several challenges and opportunities as we further develop the program in the coming years. The biggest challenge is working with students with non-overlapping schedules. It is nearly impossible to find a specific time that every scholar can make. While not every program is required or necessarily of interest to every scholar, we do plan to further implement mechanisms for asynchronous connections. Starting in Fall of 2014 we will implement some programming and support through our campus course management software, CANVAS. This is a resource all students have access to and generally need to use. It will allow us to better connect students to each other, share resources, and monitor progress on leadership plans or other active, intentional projects. It will also be an easier mechanism to scale up some of our programming to additional students. The Scholars CANVAS shell will serve as an electronic template enabling us to include others as needed or desired.

Another challenge has been formal documentation of leadership development and planning. We talk a great deal about leadership but admit we have not done as well with the follow-through. Since students will have their own concept of leadership and what such a plan would mean for them; it will take additional time resources and systematic processes to support this. However, with better use of CANVAS, there is great potential in helping students more intentionally develop leadership goals and mechanisms to achieve them. While students often think their best connections are with students in the same major or degree program, we know that networking students in an interdisciplinary way will greatly help them transition to the workforce. We can better utilize peer mentoring to assist students both in giving them an opportunity to mentor and build those leadership skills but also receive mentoring from fellow scholars. This is a natural next step, because we regularly bring in new students each year but also retain a critical mass of returning students. Peer mentoring can cross over between our multiple scholarship programs, serving a larger number of students in similar programs.

### Conclusion

By building a robust program, we are more in touch with our students and more agile to take advantage of additional student funding opportunities. The framework exists so we now can focus on modifications, improvements and expansion rather than needing to create a new program model each time a donor approaches us. Having this solid framework provides additional incentive for new sources of funding to join in our network as they see the immediate impact of their investment in our students. Finally, and most importantly, we have developed a program that not only fulfills a major student need – that of financial assistance – but also provides solid professional development, an opportunity to connect with the College in multiple ways, and feel like a stronger member of a community. Through intentional design and development of a program, we have and will continue to leverage scholarships to advance student success.

### References

1. The College Board. (2013). *Trends in College Pricing 2013*. Retrieved January 14, 2014 from <http://trends.collegeboard.org/sites/default/files/college-pricing-2013-full-report.pdf>
2. California State University. (2012). *2012-2013 Support Budget Supplemental Documentation*. Accessed January 8, 2014 from <https://www.calstate.edu/budget/fybudget/2012-2013/documentation/13-historical-suf-rates.shtml>
3. Bound, J., Lovenheim, M. F., & Turner, S. (2012). Increasing time to baccalaureate degree in the United States. *Education*, 7(4), 375-424.
4. Beeson, M. J., & Wessel, R. D. (2002). The Impact of Working on Campus on the Academic Persistence of Freshmen. *Journal of Student Financial Aid*, 32(2), 37-45.
5. Riggert, S. C., Boyle, M., Petrosko, J. M., Ash, D., & Rude-Parkins, C. (2006). Student employment and higher education: Empiricism and contradiction. *Review of Educational Research*, 76(1), 63-92.
6. St John, E. P. (2000). The impact of student aid on recruitment and retention: what the research indicates. *New directions for student services*, 2000(89), 61-75.
7. Curs, B. R., & Harper, C. E. (2012). Financial aid and first-year collegiate GPA: a regression discontinuity approach. *The Review of Higher Education*, 35(4), 627-649.
8. Angrist, J., Lang, D., & Oeropoulos, P. (2006). *Lead them to water and pay them to drink: An experiment with services and incentives for college achievement*. National Bureau of Economic Research Working Paper 12790 accessed January 15, 2014 from <http://www.nber.org/papers/w12790>
9. Kuh, G.D., et al. (2005). *Student success in college: Creating conditions that matter*. San Francisco, CA: Jossey-Bass.
10. Kuh, G. D. (2008). *High-impact education practices: What they are, who has access to them, and why they matter*. Washington, DC: AAC&U.

## Reliability Assessment Analysis for Real Time Hybrid Simulation with Fluid Viscous Dampers

Jose Valdovinos, Cheng Chen, Abbyanna Davis, Amelito Enriquez, and Wenshen Pong  
San Francisco State University/ Cañada Community College

### Abstract

By combining physical testing of experimental substructures and numerical modeling of substructures, real-time hybrid simulation technique enables large- or full-scale structural performance under earthquakes to be replicated in size limited laboratories. Due to servo-hydraulic dynamics, desired response might not be able to be accurately applied on to the experimental substructures and the resulting unsynchronized restoring force could further lead to inaccurate structural responses in experimental results. Reliability assessment of real time hybrid simulation results therefore is critical to appropriately interpret the structure performance under investigation. Viscous damping devices have been recognized to provide great energy dissipation for seismic hazard mitigation of civil engineering structures. Real-time hybrid simulation provides an effective and efficient technique to experimentally evaluate recent development in design methodology of structures with viscous damping devices. In this study the effect of actuator dynamics on real-time hybrid simulation of structures with nonlinear viscous dampers are analyzed. The resulting error is evaluated through comparison with actual response. A recently proposed approach for reliability assessment is further assessed using the computational results. The collaboration between SFSU and Cañada College provides an effective way to involve engineering students into advanced earthquake engineering research.

### Introduction

Due to the active faults all over the world, earthquakes pose significant dangers to human societies which can lead to disasters unless effective engineering countermeasures are taken into account. This natural disaster can lead to an overwhelming structural damages and loss of human lives do to the sudden release of energy form within the earth. Earthquakes urgently demand more research for more reliable and sustainable civil engineering infrastructures. Real-time hybrid simulation seamlessly integrates physical testing with numerical simulation, thus providing a cost-effective technique to evaluate seismic performance of large or full-scale structures in limited size laboratories<sup>1</sup>. Figure 1 presents the schematic concept for real-time hybrid simulation. The structure is divided into experimental substructures and analytical substructures, where the experimental substructures are tested in laboratories and the analytical substructures are numerically modeled by computer program.

Actuator delay presents great challenge for real time hybrid simulation. Various procedures have been developed to compensate for these delays to improve the accuracy of simulation results. Past research projects, such as the work from the professors of engineering in San Francisco State published in 2012 which develop a probabilistic approach for reliability assessment of real-time hybrid simulation results<sup>2</sup> especially when the true structural response is not available. A linear elastic single-degree-of-freedom structure is used to determine the statistical distribution of actuator delay values corresponding to certain accuracy<sup>3</sup>. Nonlinear structural behavior is considered through the Bouc-Wen model<sup>4</sup>. The Bouc-Wen model is used in modeling the hysteresis phenomenon in the dynamically excited nonlinear structures it is used to help further

obtain and modify the statistical distribution to account for structural nonlinearity<sup>4</sup>. The proposed probabilistic approach enables meaningful reliability assessment of real-time hybrid simulation results. To further increase the capabilities of the past research and the use of the statistical approach, fluid viscous dampers are incorporated in a similar simulation. The statistical approach is used to help analyze the data acquired and the reliability of the test.

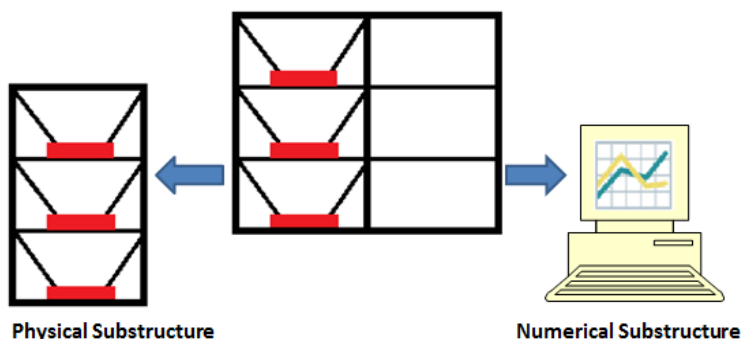

Figure 1. Schematic of real-time hybrid simulation.

### Viscous Fluid Dampers

Viscous fluid dampers are able to help buildings survive an earthquake by providing a large reduction in stress and deflection by dissipating energy from the structure.<sup>5</sup> Figure 2 shows the typical structure of a viscous fluid damper. This device works like the shocks in a car, to dissipate the forces as the car passes over a bump. This analogy is how the fluid viscous damper is able to help a bridge or a building when an earthquake hits it. Fluid viscous dampers are able to reduce stress and deflection in a structure because the force from the damping is completely out of period with the stresses due to the bending of the column.<sup>5</sup> These fluid viscous dampers are not only for earthquake forces but they can also help dissipate wind forces on tall structures like skyscrapers. Using this component is an effective and inexpensive way to acquire a reliable component for earthquake resistant structures.

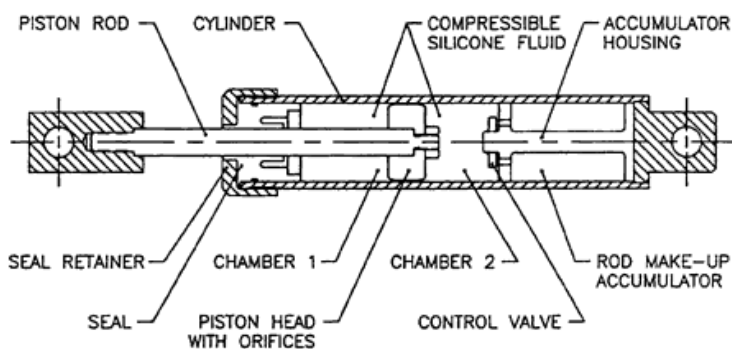

Figure 2. Fluid viscous damper<sup>2</sup>

Fluid viscous dampers have the ability to reduce or prevent a system from oscillating. Being able to mathematically model the device helps further understand the effects of the component in the system. Equations that need to be considered when dealing with dampers are shown below, equation 1 is the equation of motion where  $m$  represents the mass of the structure,  $k$  is the spring constant and  $c$  is the damping coefficient while  $F$  represents the external excitation of the

structure. The force of the damper is calculated by equation 2, where  $c$  is the damping coefficient,  $v$  is the velocity, and  $\alpha$  is the velocity component. The Damping ratio is another equation that needs to be dealt with when dealing with these viscous components, although it is a dimensionless unit it is able to describe how oscillations in the system decay.

$$m\ddot{x} + c\dot{x} + kx + c_d \times |v|^\alpha = F(t) \quad (1)$$

$$F_{dampser} = c * v^\alpha \quad (2)$$

$$\zeta = \frac{c}{2\sqrt{mk}} \quad (3)$$

### Methodology

To analyze and design this research project the fundamentals of vibrations have to be taken into consideration. A single-degree-of-freedom (SDOM) is a basic form to visualize and calculate oscillating system which can imitate more complex structures. This vibratory system is defined by a solitary mass attached to a spring and dashpot, allowing the mass to travel in one direction. Figure 3 demonstrates a mass spring damper system which is use to establish a general idea in mechanics of vibrations class and the idea of SDOM.<sup>3</sup>

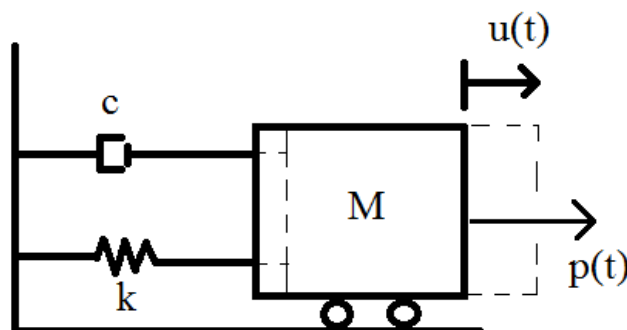

Figure 3. Mass-spring damper system.

The same ideology can be used to represent a one story structure being subjected to an external force shown in figure 4. The massless columns are able to move laterally but can't move vertically making them rigid in the vertical direction. If the roof is displaced a certain distance ( $u$ ) and then released the building will oscillate and this oscillation will continue forever with an amplitude of the displacement ( $u$ ). To make this a more effective and probable cause is having decreasing amplitude as time progresses until the structure comes back to rest at its original position. The fluid viscous damper is integrated as the absorbing element of energy to make the structures decrease in amplitude over time.



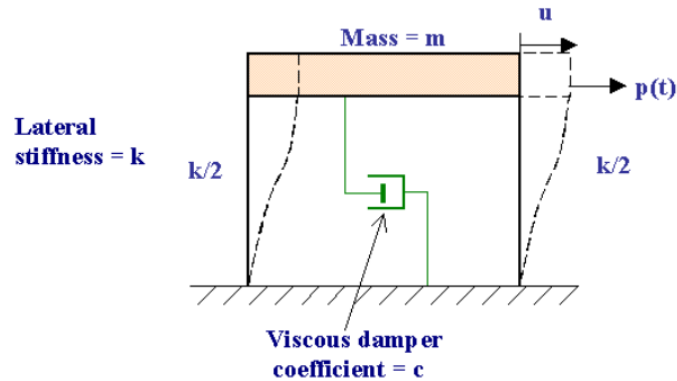

Figure 4. One story structure with damper<sup>6</sup>

The model incorporated in the simulation is taken from a previous work a professor of civil engineering at University of California at Berkeley<sup>7</sup>. A one story frame with a lumped weight of  $w=100\text{kips}$ , natural vibration period  $T_n=1\text{sec}$ , damping ratio  $\zeta=5\%$  and non-linear fluid viscous damper with  $\alpha=.5$  and  $C\alpha=3\text{kips}/(\text{in}/\text{sec})^{0.5}$ <sup>7</sup>. Furthermore 44 ground motions were taken from The Pacific Earthquake Engineering Research Center PEER Ground Motion Database. Within each ground motion three aspects were incorporated scale factors, delay, and eta. Scale factors were introduced ranging from .25 to 3 with even increments of .25 making a total of 12 scale factors. The delay ranged from 0 to .05 with evenly spaced increments of .0025 making 21 different delays. Four eta values were introduced the values were .25, .50, .75, and 1 these represent the strength factor. After gathering multiple data points for each ground motion further analysis was done to find a probable trend that will be able used.

### Computational Results

Real-time hybrid simulation greatly affects its application as an efficient and economical technique to evaluate seismic performance of structures under earthquakes. This study presents the reliability assessment of real-time hybrid simulation results by accounting for nonlinear behavior<sup>5</sup>. A delay differential equation is analyzed for real-time hybrid simulations with actuator delay. It is found that the effect of nonlinear structural behavior can be accounted for in the reliability assessment by incorporating the ductility demand during the simulation into the probabilistic time delay model. The reliability of the real-time hybrid simulation results can be evaluated by comparing the time history of tracking indicator from experiments with those using selected value from the probabilistic distribution. The proposed approach is successfully applied to real-time hybrid simulation results of a single story with a fluid viscous damper.

Matlab Simulink model was created to represent the fluid viscous damper in a SDOM structure. It had to be taken in consideration the linear and non-linearity of the fluid viscous damper. Linear fluid viscous dampers are used because they are modeled by a linear dashpot. Although it may be simplified, the component is able to reduce seismic loads on the building. A drawback on linear fluid viscous dampers is that they may develop excessive damper forces were strong velocities occur.<sup>7</sup> On the other hand non-linear fluid viscous dampers are able to manage this velocity and force relationship and have the capability to limit the highest damper force of structural velocities while still providing sufficient damping<sup>7,8</sup>. To acquire an accurate model for the non-linearity the Bouc-Wen model was used to account for this do to the versatile and mathematical tractability it has. Mathworks develop a graphical programming language tool for

modeling, simulating and analyzing multidomain dynamic systems called Simulink. Simulink is a block diagram system which provides the user with graphical editor and customizable block libraries. Simulink is combined with MatLab which helps the user integrate algorithms into models as well as transfer simulation results to MatLab for further investigation. In the Simulink model of the viscous damper a displacement is passed through a transport delay. This transport delay is then derived to gather a velocity. The velocity acquired from the derivation is processed through math functions to obtain a restoring force. The restoring force of the damper is then broken down with the restoring force of the building. The combination of these two forces is analyzed further.

Figure 5 show the simulated response of a 6.9 magnitude earthquake (recording station Nishi-Akashi) in Kobe Japan. The figure shows the exact response compared to the response when a delay is entered into the model. With a delay of 10 msec. incorporated between the command and measured, the delay produced a max error of 9.54% difference between the two. The percentage error increased as the delay increased. By having a small increment in the delay it greatly affects the simulation, this time parameter has to be acknowledged when using real-time hybrid simulation do to the effect it has to the data. Figure 6a displays all linear data for all 44 ground motions with a strength factor of 0.25. The graph shows as delay values increase the error increases. In Figure 6b the difference between the linear and nonlinear data are compared for the same earthquake. The red (nonlinear) and blue (linear) demonstrate the behavior at a scale factor of .25 which appear identical and no visible difference is seen. By taking the same ground motion and increasing the scale factor to 2.50 it is then visible that the nonlinear (magenta) data of the same ground motion has a higher max error throughout the graph compared to the linear, this trend is seen in all earthquakes and all 12 scale factors.

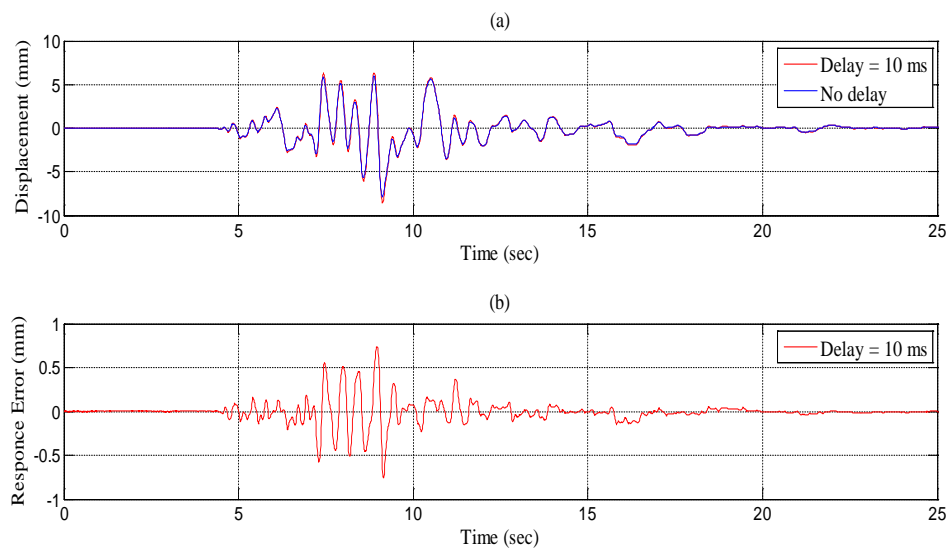

Figure 5. Measured Response vs Exact Response.

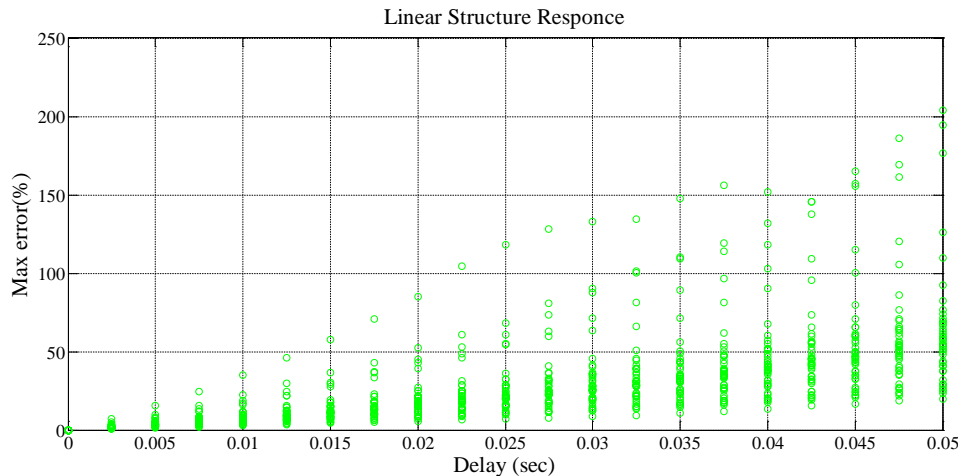

Figure 6a. Delay vs max error.

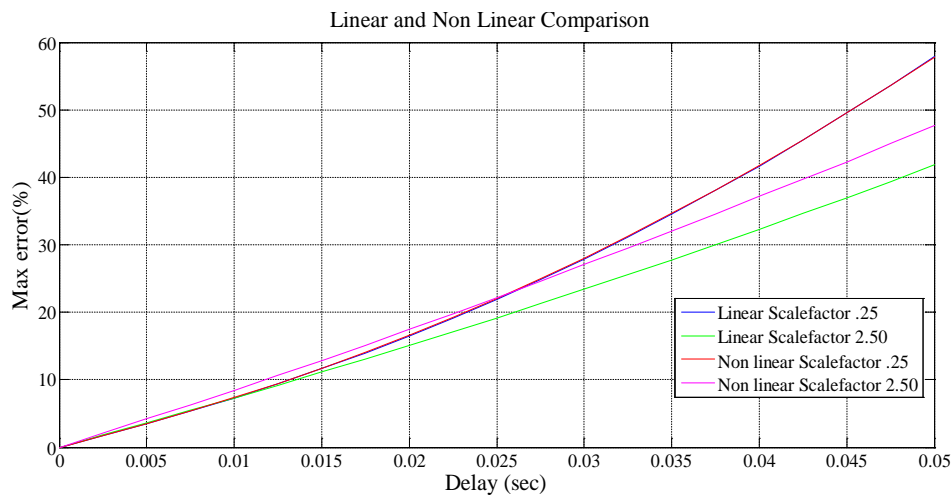

Figure 6b. Linear vs Non Linear.

### Integration with NASA CIPAIR Internship Program

Cañada College and San Francisco State University made joint efforts to install an internship in order to intensify the minority interest in the STEM fields. Thus came about COMETS, Creating Opportunities for Minorities in Engineering, Technology, and Science. This internship is sponsored by the National Aeronautics and Space Administration's, NASA, Curriculum Improvement Partnership Award for the Integration of Research into the Undergraduate Curriculum (CIPAIR). From the COMETS collaboration stemmed the Capstone Design Project, which provided the opportunity to participate in a year-long senior design project at San Francisco State University to four current community college students.

The civil engineering student Abbyanna Davis was selected to help on this research through this internship the student was able to work with simulations and allowed her to put the knowledge she has acquired through her academic pursuits to test, as well as acquire new knowledge such as the use of MatLab Simulink in order to simulate the fluid viscous dampers and the ability to give her an experience of upper division course work and research. Three main tasks include inputting the data, running simulations and analyzing the data acquired from simulation. By having

meetings every two weeks and contact through email the teamwork between the two students researchers helped make the internship much more efficient. NASA CIPAIR COMETS internship made it possible for Community College student to gain experience in the field on earthquake engineering.

### Summary and Conclusion

Real-time hybrid simulation is an efficient system to incorporate in limited size laboratories. Incorporating this simulation is able to expand the research possibilities for researches in earthquake engineering. The implementation of the viscous fluid damper in the simulation and the use of the model are able to help further comprehend the effects of this component on earthquake resistant structures without increasing major cost for the institution. The COMETS program has been successful in engaging minorities in community college in research opportunities and further interest in math and science major. The integration between the NSF BRIGE project and the NASA CiPair project provides an effective way to engage community college students into advanced earthquake engineering research.

### Acknowledgement

This research is supported by the National Science Foundation under the award number CMMI-1227962. The authors would also like to acknowledge support from San Francisco State University ORSP Grant SP692 as well as the help of Cañada Community College and the cooperation of NASA Curriculum Improvements Partnership Award for the Integration of Research CIPAIR. Any opinions, findings conclusions and recommendations expressed in this paper are those of the author and do not necessarily reflect those of the sponsors.

### References

1. Chen, C. and Ricles, J. M. (2012), Large-scale real-time hybrid simulation involving multiple experimental substructures and adaptive actuator delay compensation. *Earthquake Engng. Struct. Dyn.*, 41: 549–569. doi: 10.1002/eqe.1144
2. Chen, C., Sharma, R. and Pong, W.S., (2012), “Assessing Reliability of Real-Time Hybrid Simulation Results using a Probabilistic Approach,” *15th World Conference on Earthquake Engineering*, September 24-28, Lisbon, Portugal.
3. Chen, C. (2012), “Reliability Assessment of Real-Time Hybrid Simulation using a Probability-Based Tracking Indicator,” accepted for *The International Symposium on Reliability Engineering and Risk Management (ISRERM’2012)*, August 5-8, Yokohama, Japan.
4. Wen, YK. Equivalent linearization for hysteretic systems under random excitation. *Journal of Applied Mechanics*, Transaction of ASME, 1980; 47:150-154.
5. Haskell, Gregg, and David Lee. "Fluid Viscous Damping as an Alternative to Base Isolation." Technical Papers Online. Taylor devices, n.d. Web. 28 Nov. 2013. <<http://taylordevices.com/fluidviscousdamping.html>>.
6. Chopra, A. K. (1980). *Dynamics of structures*. Berkely: Earthquake Engineering Research Lin,
7. W.-H. and Chopra, A. K. (2002), Earthquake response of elastic SDF systems with non-linear fluid viscous dampers. *Earthquake Engng. Struct. Dyn.*, 31: 1623–1642. doi: 10.1002/eqe.179
8. Institute.
9. Goel, R. K. (2005), Seismic response of linear and non-linear asymmetric systems with non-linear fluid viscous dampers. *Earthquake Engng. Struct. Dyn.*, 34: 825–846. doi: 10.1002/eqe.459

## **Combination of Shake Table Experiments and Computer Simulation to Enhance Structural Engineering Curriculum in Earthquake Engineering**

Lisa Wang  
California State Polytechnic University, Pomona

### **Abstract**

This paper describes the new components incorporated to the Structural and Earthquake Engineering curriculum to help students learn about earthquake engineering principles and seismic resistant design of structures. For undergraduate students, structural dynamics and earthquake engineering are difficult subjects for them to fully understand, and most of students find it too theoretical. Hands-on experiential learning through shake table experiments improves students' understanding on these subjects, as the key concepts in Earthquake Engineering can clearly be portrayed through shake table experiments. Students investigate the validity of computer models by comparing the predictions with shake table experimental results. Such comparisons help students recognize the value of modeling and simulation and thus, become motivated to learn the theory and build up their analytical skills. Through such experiences, theory becomes valuable to them and the hands-on experiential experience adds depth to theoretical understanding. The assessments by the department industry advisory board and practicing engineers showed that the senior projects in the area of earthquake engineering are rigorous in the technical contents and that the students demonstrated their knowledge on the dynamic response of structures such as buildings and bridges to dynamic loads. The integration of such components to structural engineering education promotes students' interest in the subject area and motivates them to stay in the field and earn their BSCE degree.

### **Introduction**

The importance of understanding the effects of earthquakes on structures to the civil engineering community is apparent. Recent catastrophic earthquakes (such as 2011 Japan Earthquake and 1993 Northridge Earthquake) have caused severe damage to buildings, bridges, and crucial lifeline infrastructures. During the Northridge earthquake, for example, about 12,500 structures were moderately to severely damaged including residential homes, businesses, and freeways (see Figure 1). Approximately 114,000 residential and commercial structures were damaged and 72 deaths were attributed to the earthquake. Damage costs were estimated at \$25 billion. On March 11, 2011, a magnitude-9 earthquake shook northeastern Japan. The effects of the great earthquake were felt around the world, from Norway's fjords to Antarctica's ice sheet. More than 18,000 people were killed in the disaster, with severe structural damage in northeastern Japan (see Figure 2), including heavy damage to roads and railways as well as fires in many areas.



Figure 1. Structural failures of building and bridge in the 1994 Northridge earthquake.



Figure 2. Structural damages in 2011 Japan earthquake.

The most important lesson learned from both earthquakes is that structural engineers must possess the skills to significantly improve structures to resist earthquake damage and thereby avoid most of the deaths and financial losses. Past earthquakes have demonstrated that it usually costs less to prepare for earthquakes in advance than to repair the damage afterwards. It is urgent to train a new generation of civil engineers that possesses understanding of seismic engineering who are qualified in design of new buildings and retrofit of the existing structures. Wang<sup>5</sup> used shake table to help students better understand the structural dynamic behavior in earthquake engineering and emphasized the importance of using models in teaching structural dynamics.

The reality is that, in California most of the civil engineering programs in California state universities (also some of the UCs) don't yet offer any course in Earthquake Engineering for undergraduate students. In a civil engineering curriculum the structural dynamics course is the first opportunity for the students to be exposed to earthquake engineering subjects. Since undergraduate students usually find it difficult or confusing to solve basic structural dynamics problems, it is very beneficial to the students if the course can be taught effectively with the following components: classroom demonstration, computer simulation and laboratory experiments.

Educational research has demonstrated the effectiveness of the instructional strategies, particularly computer simulations<sup>1-2</sup>, in improving student learning. Also, from the education psychology viewpoint, computer simulations create an atmosphere, in which students may initiate actions, learn how to be more independent, analyze and make conclusions. Through carefully-designed educational experiments that included control and experimental groups, computer simulations can improve students' understanding of physical phenomena as well as analytical and creative thinking skills. Another study<sup>4</sup> investigated the effects of computer simulations to the students prior to performing laboratory experiments helped students predict the physical phenomena in subsequent laboratory experiments, and that the computer simulations added depth to students' theoretical understanding of scientific principles.

### Need of Innovative Teaching Practice

The developed computer simulation module has three features: incorporating a real-world engineering example into computer simulations, integrating mathematical calculations into computer simulations, and offers interactive learning experiences for students. Earthquake Engineering components have been incorporated into the civil engineering curriculum at Cal Poly Pomona. Even though the subject is difficult for undergraduate students as they find it too theoretical, carefully designed classroom demonstrations and laboratory experiments can motivate students to learn the subject matter. Even at the undergraduate level, concepts in Structural Dynamics and Earthquake Engineering can clearly be portrayed through shake table experiments. Such learning experience has helped students to relate to the theory they learn from classroom.

By performing computer simulations prior to laboratory experiments, students can predict the physical phenomena in subsequent laboratory experiments, and that the computer simulations added depth to students' theoretical understanding of scientific principles. The opportunity for students to investigate the validity of computer models by comparing the predictions with shake table experiments is uniquely beneficial to the students. Such comparisons help students recognize the value of modeling and simulation and thus, become motivated to learn the theory and build up their analytical skills. Through such experiences, theory becomes valuable to them and the hands-on experiential experience adds depth to theoretical understanding. As such, civil engineering students can be trained to become competent professionals after their graduation.

The objectives of such teaching practice are to: 1) integrate experimental structural dynamics into the undergraduate and graduate curriculum so that students have effective "hands on" learning exercises, with visual feedback of results; 2) help undergraduate students gain computer modeling/simulation skills; 3) motivate students to learn earthquake engineering theory so as to gain qualifications as future civil engineers.

### Teaching Activities at Undergraduate and Graduate Levels

Depending on the course, students either use one of the shake tables or both of the shake tables available in the laboratory. The comparison between the small shake table (single-axial seismic excitation) and the large shake table (with seismic excitation in two orthogonal directions) is illustrated in Table 1.

Table 1. Comparison between shake tables used for the laboratory experiments.

Features/Specifications	Small Shake Table (Uni-axial)	Large Shake Table (Bi-axial)
Table Size	17" x 13"	40" x 25"
Maximum Payload	25 lb	120 kg (265 lb)
Ground Motion Input	Uni-axial excitation	Bi-axial excitation
Application	Instruction	Research & Instruction
Output	Qualitative	Quantitative
Data Acquisition	Not Available	Available
Sensors equipped	No	Yes
Control Software	No	Yes

The shake tables can reproduce the historical earthquake ground motions for students to study the structural behavior during earthquakes. The equipment is used to integrate labs, lectures, and computer modeling; such teaching practice helps students to effectively learn the earthquake engineering subjects.

*Uni-axial shake table (bench-scale instructional shake table)*

For the purpose of classroom illustrations, bench-scale instructional shake tables, such as tabletop MTS T-TEQ earthquake simulator shown in Figure 3, is ideally suited for classroom demonstrations and hands on learning experiences. This tabletop earthquake system is capable of generating the historic earthquakes as well as random and sinusoidal excitation. As the instructional shake table is small in size and electrically operated, it can be used in classroom demonstration as well as the lab operation.



Figure 3. Small shake table (single-axial excitation).

*Bi-axial shake table (xy shake table)*

Quanser shaker III (or xy shake table) shown in Figure 4 has a 265-pound payload capacity. The operational bandwidth is 20 Hz. The peak velocity is 25 in./sec with a 1.9g peak acceleration and stroke of 8 in. Dual-Axial testing allows multi-axis testing configuration in orthogonal directions. This capability will allow users the flexibility in having multi-axis loading conditions.

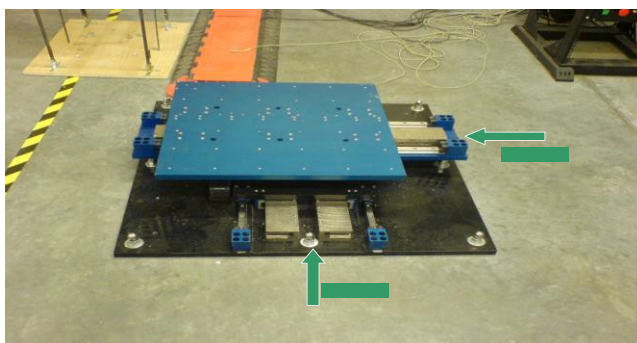

Figure 4. Large shake table (seismic excitation in two directions).



By exciting the specimen (testing model) in two lateral perpendicular directions, the shake table is effective in simulating the natural earthquake. This is especially the case with the torsion effect on the structural members and connections, where structural failure occurs frequently during earthquakes. The shake table is equipped with signal processing and data acquisition as well as accelerometers so that students are able to make some meaningful comparisons between the experimental responses and the analytical predications. It is an effective means for research on seismic performances of three-dimensional structures. The major teaching activities involving the equipment are shown in Table 2.

*Response measuring devices (sensors).* Obtaining experimental results on the seismic response of test structures is highly important as it can motivate students to learn the theory. In addition to observing structural behavior, engineering students need to obtain quantitative lab measurements that are compared with analytical predictions. To perform seismic design of structures, engineers need to obtain the maximum displacement response and acceleration response. Therefore, linear displacement sensor and accelerometer are the two types of sensors used in the laboratory.

The displacement sensor used was model HS100 by Vishay micro measurements, as shown in Figure 5. Accelerometers are the core of the vibration monitoring, data collection process. They are one of the most successful micro sensors ever developed. The specific accelerometer used for our project was a Crossbow LF series, as shown in Figure 7. The accelerometer can measure accelerations up to 2g.

Table 2. Teaching activities in various courses at both undergraduate and graduate levels

Course #	Course Title	Activities
CE306L	Structural Materials Lab ( for undergraduate juniors)	<ul style="list-style-type: none"> <li>- Demo using small shake table (students can operate table themselves – hands-on experience)</li> <li>- Exposure to computer modeling in groups</li> <li>- Oral presentation and discussion</li> </ul>
CE491/2/3	Senior Project (for undergraduate seniors)	<ul style="list-style-type: none"> <li>- Lab experiment using large table in group, followed with linear computer modeling in group</li> <li>- Oral presentation and discussion</li> <li>- Seismic design based on the analysis results</li> <li>- Research training experience with advanced computer modeling and 3D simulation</li> </ul>
CE 499	Introduction to Structural Dynamics (undergraduate elective)	<ul style="list-style-type: none"> <li>- Lab experiment using small and large tables in group</li> <li>- Computer modeling (linear analysis) individually</li> <li>- Comparison between lab measurements and computer analysis results</li> <li>- Validation of computer modeling skills with theory and lab experimental results.</li> <li>- Research training experience with advanced computer modeling and 3D simulation</li> </ul>

CE 521	Structural Dynamic (graduate course)	<ul style="list-style-type: none"> <li>- Lab experiment using bi-axial tables in group</li> <li>- Computer modeling (linear and nonlinear analysis) individually</li> <li>- Comparison between lab measurements and computer analysis results</li> <li>- Discussion on effects of nonlinearities on structural behavior, and control devices used</li> </ul>
--------	---	--



Figure 5. Linear displacement sensor used to measure story drift.

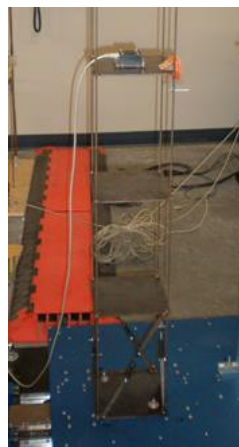

Figure 6. Accelerometer and its application at floor/roof levels.

### Computer Modeling and Simulation

With respect to earthquake engineering subjects, a meaningful learning experience in computer modeling and simulation will only take place if students have mastered appropriate fundamental background course materials. It is also important to consider the computational nature of the discipline, especially keeping in mind that the analytical predictions will help students understand the structural behavior observed through laboratory experiments. As a result, a five-

story moment frame building structure (test specimen) was built, and a computer model was developed accordingly, with the exact same geometric and material properties, as well as the connection type and base support type. Figure 7 is the computer model of the steel moment frame test structure. The ground motion used in the laboratory experiment was from Northridge Earthquake (Hollywood Storage Station), which was also used for the computer analysis (ETABS program is used) to be consistent. Figure 8 is a plot of the ground acceleration history used.

Figures 9 and 10 are on the comparisons between the computer analysis results and the experimental results (measured through sensors). It was easily observed that the experimental frame and the computer model behave very similarly under the same dynamic conditions. The periods and the peaks of acceleration and displacement time histories matched very closely. Table 3-1 also gave very close values in between the experiment and the computer model. Considering the many imperfections in the experiment, the error was small.

Such comparisons gave comfort in validating students' computer modeling skills. The error of peak acceleration between computer analysis and experimental results was only 3.7%. Through such experiences, students were motivated to perform computer modeling; theory becomes valuable to them and the hands-on experiential experience adds depth to theoretical understanding.

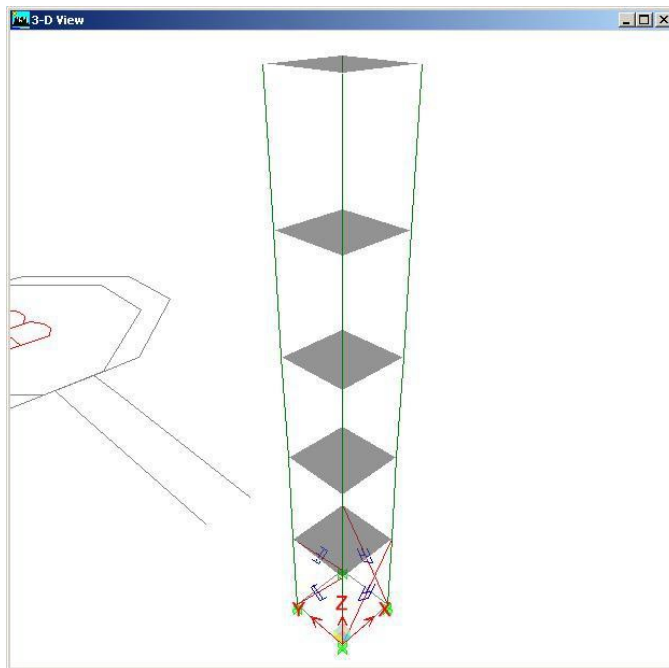

Figure 7. Computer model for the 3-D frame structure (shown on the right).

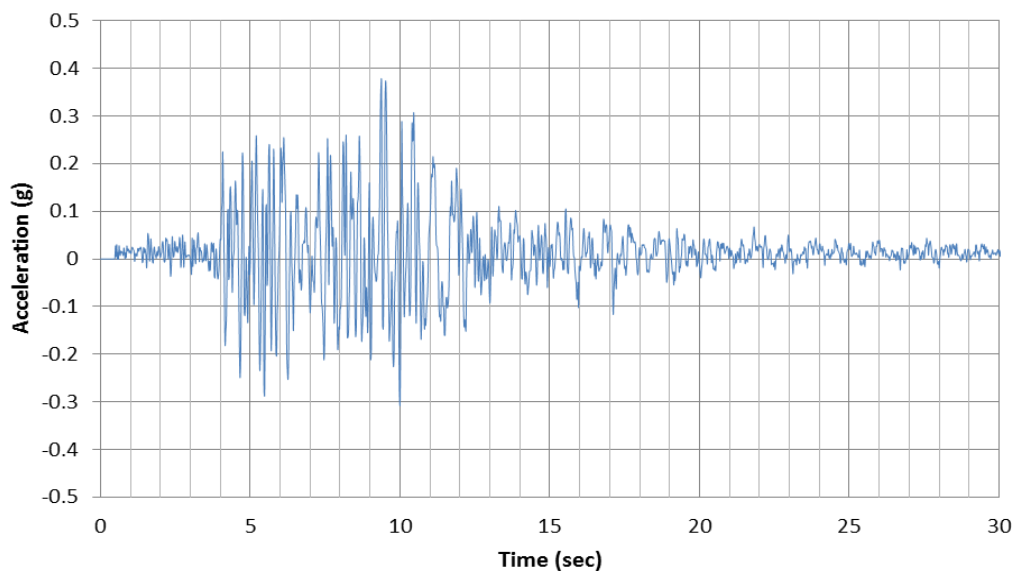

Fig. 8. Ground acceleration input generated by shake table

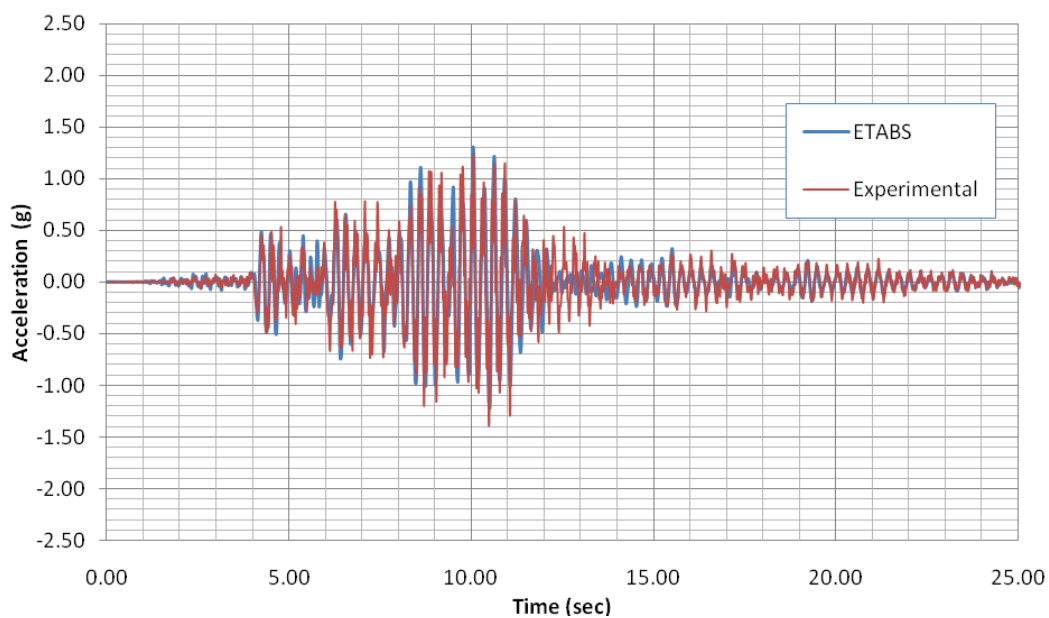

Figure 9. Acceleration comparison: Computer analysis results vs. experimental measurements.

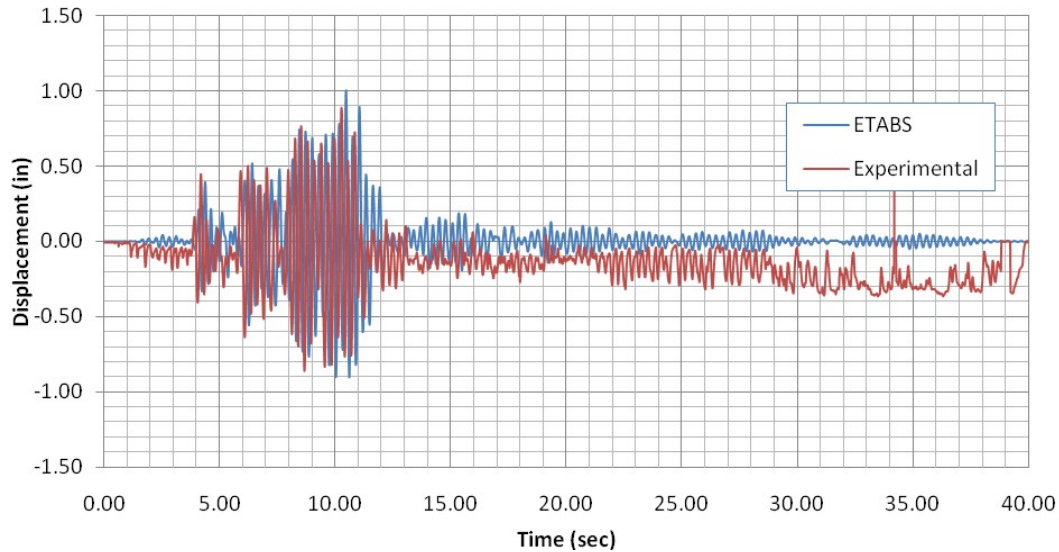

Figure 10. Displacement comparison: Computer analysis results vs. experimental measurements.

Table 3. Comparison between analytical predictions and experimental measurements.

	Maximum acceleration (g)	Maximum displacement (in)
experiment	1.39	0.89
ETABS	1.34	1.01
% difference	3.5%	13%

### Other Laboratory Experiments Developed

A series of experiments have been established. The experiments varied from basic demonstration of structural dynamics, structural control and failure identification. In addition to observing physical behavior, students verify the measured response with both theory and computer applications. Computer simulations through commercial program SAP2000 and/or ETABS have been performed.

The following is the list of the experiments/projects developed through undergraduate senior projects/research training projects.

1. Natural Frequency Determination From Free Vibration Test (classroom demonstration)
2. Structural Failure Detection of Braced Frame Structure Systems (Figures 12 & 13)
3. Experimental Determination on Damping Ratio of Structural Systems (Figure 5)
4. Experimental Determination of Natural Frequencies and Mode Shapes of MDOF Structure Systems (laboratory observation through various experiments)
5. Base isolation on structural control (Figure 11 & 12)
6. Friction damper on a timber apartment building (Figures 15 & 16)
7. Liquid sloshing effect on Elevated water tank (Figure 17)

Some of the projects have been incorporated into the structural engineering curriculum in the structural testing lab, and earthquake engineering lecture courses at undergraduate and graduate levels.



Figure 11. Undergraduate students work in groups on research training projects.

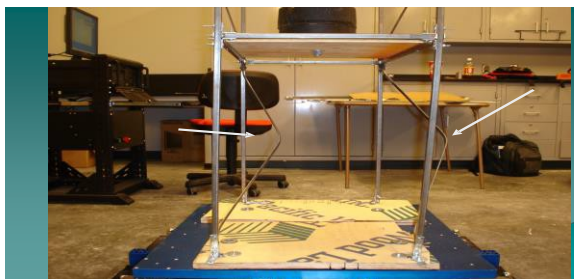

Figure 12. Test specimen for a braced frame structure.

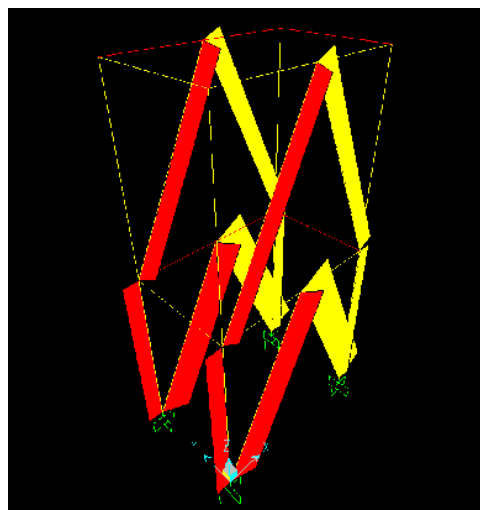
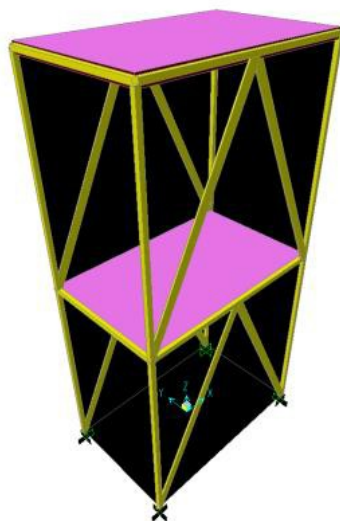

Figure 13. Computer modeling of test structure and analytical results.

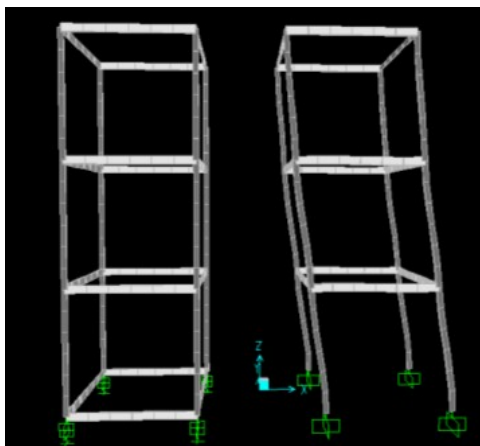

Figure 14. Base-isolated structural systems.

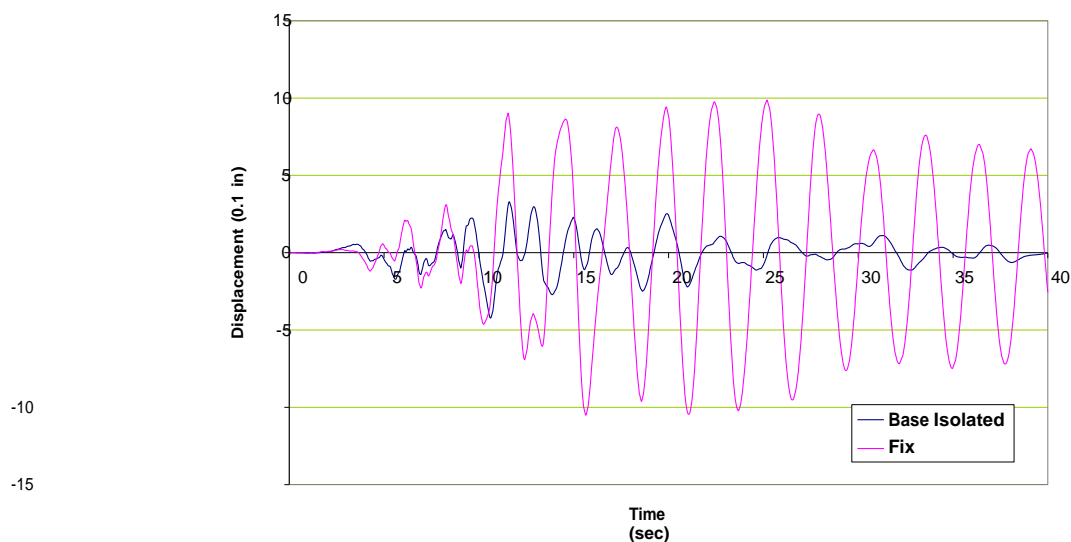

Figure 15. Comparison on seismic response between conventional fixed-based structure and the base-isolated structure (base isolation effect).

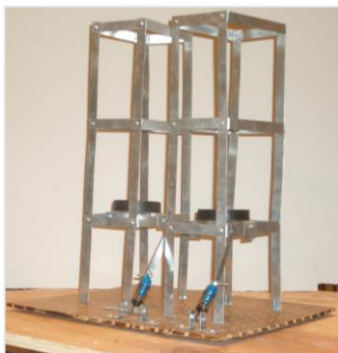

Figure 16. Conventionally fixed model on left and viscous fluid damped model on the right.

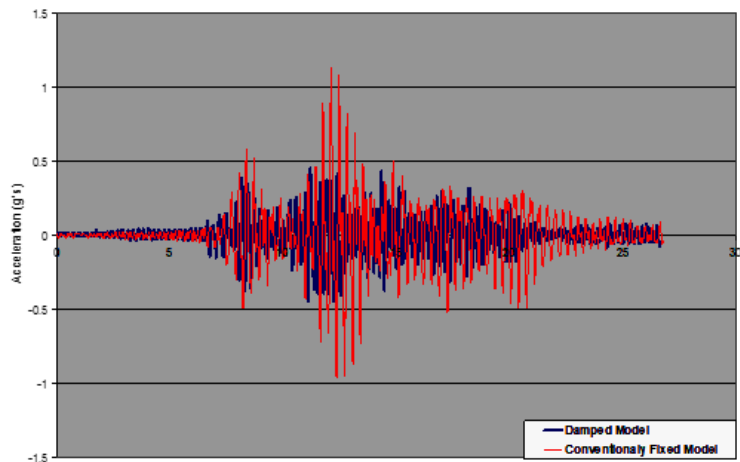

Figure 17. Comparison between the fixed-base structure and the damped structure.



Figure 18. Multi-story housing structure with friction damper at the base level.



Figure 19. Non-structural and structural failures occurred during testing without damper.





Figure 20. Elevated water tank model on the liquid sloshing effect.

### Questionnaire Survey

A questionnaire survey was conducted to ask students to provide feedback on the following statements: 1) Please describe if the computer simulation was helpful to motivate you to learn the theory of earthquake engineering; 2) Please describe if the lab experiments were helpful to portray the structural response as predicted by the theory; 3) If yes, please share which experiment you think is most effective; and 4) Please describe your experience in comparing computer analysis results and the lab experimental results. The class questionnaire survey results showed students had positive learning experiences with the developed computer simulation against lab measurement module. The students appreciated such class assignment and activities in learning earthquake engineering and felt comfortable with the subject matter after such experience; most of the students stated that they would like to learn the advanced knowledge of the subject and pursue a master's degree in structural and earthquake engineering.

For the undergraduate research training projects (mostly through senior projects), the students' work was assessed during the College of Engineering Project Symposium event. During their presentations of such projects, the civil engineering faculty, and practicing structural engineers invited from local civil engineering firms, conducted assessments of such projects and provide feedbacks. The assessments by the IAC (Industry Action Council) members and practicing engineers stated generally on the assessment forms that the projects were rigorous in the technical contents and that the students were passionate and confident in sharing their technical work. In terms of students' grades, they were assigned on the basis of report and presentation quality, not only in terms of technical content but also in terms of knowledge integration.

### Limitation of the Present Study and Future Work

Due to the tremendous amount of work in the expansion of the curriculum and development of the learning activities and assignments, as well as the design and construction of the test structures (specimens) , only limited assessment work was conducted. In the future, both qualitative and quantitative assessment strategies are planned. Quantitative assessment such as pretest and posttest can provide feedback on if and/or how computer modeling fostered a significant conceptual change and understanding of the earthquake engineering theoretical principles. In addition, through semi-structured interviews, students can provide more

substantial feedback in their learning experience. Such exclusive feedback can be used to refine and strengthen such teaching practices.

### Conclusions

The shake table experiments have helped students effectively in understanding the dynamic response of structures such as buildings and bridges to dynamic loads. Through effective experimental illustrations of shake tables, students especially undergraduate students are exposed to the topics of Structural Earthquake Engineering. The experiments have provided the students with a background in the basic principles of structural dynamics, and the implications of these principles in structural design. Students were able to broaden their perspective on what civil engineers can do, and this will lead them to be interested in pursuing advanced knowledge in the subject area. Students indicated that the hands-on exercise and the lab exercises enhanced their understanding of the subject matters. The questionnaire survey results also show that students had positive experiences with the developed computer simulation module. The assessments by the department industry advisory board and practicing engineers showed generally that the projects are rigorous in the technical contents and that the students' confidence level are much improved.

### Bibliography

1. N. Fang, K. Nielson, and S.M. Kawamura "Integrating Real World Engineering Examples and Mathematical Calculations Into Computer Simulations to Improve Students' Understanding of Concept Pairs," *Proceedings of the ASEE 2012 Annual Conference & Exposition*, San Antonio, Texas, June 10 - 13, 2012.
2. Maria, K. and Romuald, K., 2009, "Computer Simulation in Learning Physics as A Useful Teaching Method" – A Report of Research," *New Educational Review* 19(3-4), pp. 83-94.
3. G. Javidi, J. White, and E. Sheybanil "Virtual lab in engineering curriculum," *Proceedings of the 2005 American Society for Engineering Education Annual Conference & Exposition*, Portland, Oregon, June 12-15.
4. Z. Zacharias, and O.R. Anderson, 2003, "The Effects of an Interactive Computer-Based Simulation Prior to Performing a Laboratory Inquiry-Based Experiment on Students' Conceptual Understanding of Physics," *American Journal of Physics* 71(6), pp. 618-629.
5. L.Y. Wang, "Illustration of Shake Table Experiments in Structural Engineering Curriculum," *Proceedings of the 2002 American Society for Engineering Education Annual Conference & Exposition*.
6. S.J. Dyke, S.M. Johnson, R.T. Ranf, J.M. Caicedo, and M. Soto-Fourier "Advancing Earthquake Engineering Education through a Cooperative Effort Based on Instructional Shake Table," *Proceedings of the seventh U.S. National Conference on Earthquake Engineering*, Boston, Massachusetts, July 2002.
7. M.G. Battaini, B.F. Spencer Jr. (1999). "Bench-Scale Experiment for Structural Control," *Journal of Engineering Mechanics*, ASCE, Vol. 126, Feb., pp. 140-148.
8. A.R. Kukreti and B.J. Wallace "Teaching Dynamic Behavior of Structures Using Small-Scale Structural Dynamics Laboratory," *Proceedings of the 31st Midwest Section ASEE Conference*, Tulsa, Oklahoma, April 10 12, 1996.

## **Carbon Nanotube Composites: Using an Authentic Engineering Research Problem to Engage Middle School Students in STEM**

Nancy Warter-Perez, Sevak Ghazaryan, and Jerardo Martin  
California State University, Los Angeles/ Stevenson Middle School

### **Abstract**

Since 2008, the IMPACT LA NSF GK-12 Program (Improving Minority Partnerships through CISE (Computer, Information Science & Engineering)-related Teaching) has been partnering graduate teaching fellows with middle and high school science and math teachers within the East Los Angeles area. The Cal State L.A. graduate fellows serve as visiting scientists and engineers who work closely with their partner teachers to engage middle and high school students in science and engineering activities related to the fellows' research. The program goals are to enhance STEM (Science, Technology, Engineering, and Mathematics) curriculum, inform and inspire students about careers in science and engineering, and improve the graduate fellow's ability to communicate their research to a broad audience. In this paper, we present the middle school math classroom activities developed related to one particular fellow's research on carbon nanotube composites. Using lightweight carbon nanotube composites for a car chassis can increase fuel efficiency, decrease emissions, and maintain the desired properties of the chassis including its structural integrity measured by strength and toughness and its ability to conduct electricity to ground a car in a lightning strike. The activities developed are tied to 6<sup>th</sup> – 8<sup>th</sup> grade California math standards and provide students with an opportunity to see how math can be used to solve authentic engineering research problems. Pre and post-surveys were conducted to measure the impact of the visiting engineer/scientist and the research-related activities on students' perceptions towards engineers and scientists and their desire to pursue a career in engineering or science. The results related to this particular research are presented as well as the results and findings for all fellows during the 2012-13 school year.

### **Introduction**

Innovations in science, technology, engineering, and mathematics (STEM) fields help shape our society and drive our economy<sup>1</sup>. Not only is there a need for more scientists and engineers, many jobs today require that the workers are STEM-capable, meaning that they are able to apply STEM knowledge to perform their jobs. Furthermore, more and more it is becoming important for people in their daily lives to be STEM literate. Even though the demands for quality STEM education are increasing, U.S. students lag behind those from the highest performing nations on international assessments<sup>2</sup>. Moreover, the achievement gap is even greater for underrepresented minority and low-income students<sup>3</sup>. To address these issues, the National Research Council (NRC) report on Successful K-12 STEM Education identified three goals for U.S. STEM education<sup>4</sup>:

- Goal 1: Expand the number of students who ultimately pursue advanced degrees and careers in STEM fields and broaden the participation of women and minorities in those fields.

- Goal 2: Expand the STEM-capable workforce and broaden the participation of women and minorities in that workforce.
- Goal 3: Increase STEM literacy for all students, including those who do not pursue STEM-related careers or additional study in the STEM disciplines.

Since 2008, the IMPACT LA NSF Graduate STEM Fellows in K-12 Education (GK-12) Program at California State University, Los Angeles has been working to achieve similar goals by partnering graduate teaching fellows with middle and high school science and math teachers within the East Los Angeles area<sup>5-8</sup>. IMPACT LA Graduate fellows conduct Master's thesis research in a wide array of STEM disciplines, which over the years have included Computer Science, Computer/Electrical Engineering, Bioinformatics, Biomedical Engineering, Mechanical Engineering, Civil Engineering, Biology, Chemistry, and Physics. Fellows work in their partner teacher's classroom as visiting scientists and engineers for 10 hours per week throughout the entire school year. In the classroom fellows present their research, conduct research-related activities, talk about their college experience, and assist the teacher through lectures and other activities. The students also visit the Cal State LA campus during the IMPACT LA Open House where they are able to visit their fellow's research lab, see other fellows' labs, learn about pathways to college, participate in a fun engineering challenge, and hear about different engineering and science careers from industry representatives.

In this paper, we present the classroom activities developed for a middle school math classroom that are related to a mechanical engineering fellow's research on carbon nanotube composites. The activities developed are tied to 6<sup>th</sup> – 8<sup>th</sup> grade California math standards and provide students with an opportunity to see how math can be used to solve authentic engineering research problems. Pre and post-surveys were conducted to measure the impact of the visiting engineer/scientist and the research-related activities on students' perceptions towards engineers and their desire to pursue a career in engineering or science. The results related to this particular research will be presented as well as the results and findings for all fellows during the 2012-13 school year.

### **Carbon Nanotube Composites – An Authentic Research Problem**

*Overview.* The main objective of this research project is to create composite materials with a carbon nanotube matrix that will replace more conventional metal alloys. Carbon nanotubes are known for their great structural properties and preliminary research shows that they can increase the strength of any given composite material more than 30%. The composite under study consists of three parts epoxy and one part hardener with single walled carbon nanotubes (SWNT) uniformly distributed throughout the mixture. If carbon nanotube composite materials are used to replace the metal alloy chassis currently used in cars these days that would reduce the weight of the car and in turn will reduce gas consumption and emissions.

*Bringing research into the classroom through hands-on activities.* Five activities were created to bring the research on carbon nanotube composites into the classroom. Through these activities, students can gain an appreciation for the difference between strength and toughness and how to measure these traits in a composite material; the conductivity of graphite; design trade-offs when utilizing composite materials; the corrosion-free property of carbon nanotube composites; and the molecular structure of a carbon nanotubes to gain an understanding how a hexagonal structure can be strong. These activities were conducted with 6th through 8th grade mathematics

students in varying math courses including: Math 6, Math 7, Algebra 1, and Geometry. These lessons not only demonstrate to the students the benefit of using carbon nanotube composites for car chassis, they also teach students important math concepts based on the mathematical common core standards<sup>9</sup> as shown in Table 1.

The lesson plans and supporting material for these activities, along with lesson plans from other fellows, can be found at the IMPACT LA NSF GK-12 website<sup>10</sup>. The descriptions of the activities below are based on the content of the lesson plans which are written for middle school teachers and their students. To assist the teachers and students, the lesson plans have keyword definitions to define important and perhaps unfamiliar terminology (the keyword definitions are not provided here). There are combinations of short and long lesson plans available on the website, where the long lesson plans provide deeper coverage of the background material to help teachers understand and present the material.

*Strength vs. toughness activity.* When an engineer designs a product, they need to select materials that are safe and cost effective. For example, a car body is traditionally made from metal alloy, because it needs to be strong and safe, however it's also expensive. Composite materials are often more affordable and can be used as a replacement for metal alloys in some products. How do engineers decide if a given composite material can be used to replace a conventional metal alloy? Engineers conduct strength and toughness tests on the composite materials. If the test results show that composite material demonstrates strength and toughness equivalent to metal alloy, then the composite can be used as a replacement.

Between an egg and a lime, which one is tough and which one is strong? In this activity, students conduct stress and toughness test on a lime and an egg. For the toughness test, students drop an egg and a lime from a given height and observe that only the egg breaks, but nothing happens to the lime. This observation shows that the lime is tough enough to take on the forces exerted by the floor.

Table 1. Mapping the classroom activities to Common Core State Standards (CCSS) in mathematics<sup>6</sup> for grade levels 5 through 7.

	Strength vs.	SWNT Flashlight	Composite Rocket	Hydrolysis	Molecular Structure of Carbon Nanotubes
<b>Measurement and Data</b>					
CCSS.Math.Content.5.MD.A.1 Convert among different-sized standard measurement units within a given measurement system (e.g., convert 5 cm to 0.05 m), and use these conversions in solving multi-step, real world problems.		✓		✓	✓
<b>Ratios and Proportional Relationships</b>					
CCSS.Math.Content.6.RP.A.1 Understand the concept of a ratio and use ratio language to describe a ratio relationship between two quantities.	✓	✓	✓	✓	✓

CCSS.Math.Content.6.RP.A.2 Understand the concept of a unit rate $a/b$ associated with a ratio $a:b$ with $b \neq 0$ , and use rate language in the context of a ratio relationship.	✓	✓	✓	✓	✓
CCSS.Math.Content.6.RP.A.3d Use ratio reasoning to convert measurement units; manipulate and transform units appropriately when multiplying or dividing quantities.		✓		✓	✓
CCSS.Math.Content.7.RP.A.1 Compute unit rates associated with ratios of fractions, including ratios of lengths, areas and other quantities measured in like or different units.	✓		✓	✓	✓
<b>Geometry</b>					
CCSS.Math.Content.6.G.A.1 Find the area of right triangles, other triangles, special quadrilaterals, and polygons by composing into rectangles or decomposing into triangles and other shapes; apply these techniques in the context of solving real-world and mathematical problems.					✓
CCSS.Math.Content.6.G.A.4 Represent three-dimensional figures using nets made up of rectangles and triangles, and use the nets to find the surface area of these figures. Apply these techniques in the context of solving real-world and mathematical problems.					✓
CCSS.Math.Content.7.G.B.6 Solve real-world and mathematical problems involving area, volume and surface area of two- and three-dimensional objects composed of triangles, quadrilaterals, polygons, cubes, and right prisms.					✓

For the strength test, a tensile/compression machine, TCM200, is used to calculate how much load it takes to break an egg and a lime. The results are displayed by graphical means as shown in Figure 1. The x and y axis of the graph, display time and load respectively. Based on the graph students should be able to identify the amount of load it takes to break an egg and a lime. If a TCM200 tensile machine is not available for strength testing, teachers may use books as weights for strength test. To give students experience reading graphs, sample graphs from a TCM200 machine are provided as shown in Figure 1.

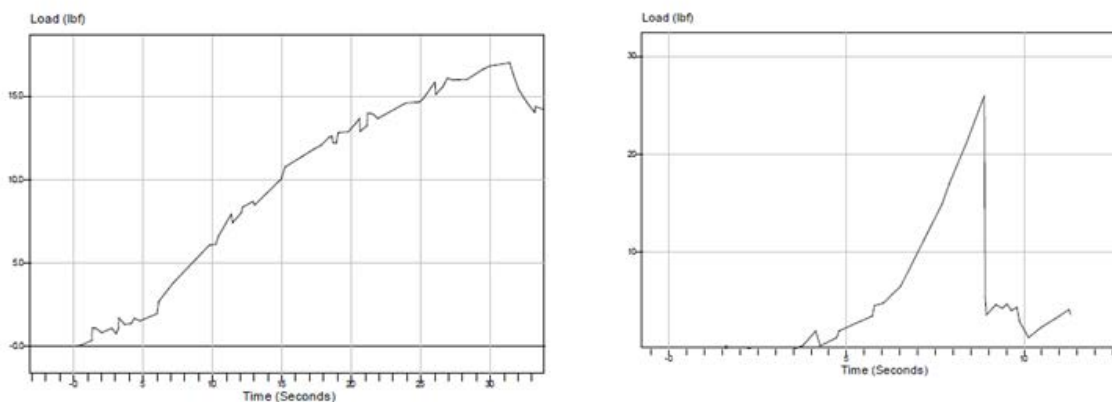

Figure. 1. Students use graphs to analyze how much load it takes to break a lime (left) and an egg (right).

*Conductivity of graphite (SWNT flashlight) activity.* Almost all mechanical devices starting from household appliances to space technology such as satellites are controlled electronically. To control such devices engineers and scientist use circuits ranging from simple electric circuits to complex computers, which can compute millions of calculations in a matter of seconds. Until recently computer circuit boards used copper, silicon and gold to transfer electrical current and

signals throughout the circuit board, because these materials have relatively low resistance to electrical current. Engineers and scientist are always looking for new materials with which they can make new computers with faster processing speed. One such material is graphite. Graphite and single wall carbon nanotubes (SWNT), which are made from graphite, are slowly and surely finding their place in computer technology, because they have very little resistance to electrical current. In addition, the conductivity of carbon nanotube composites is desirable for car chassis so that it can conduct electricity to ground during a lightning strike.

In this activity students observe and understand how electrical current can be transferred through graphite. Figure 2 shows a simple electrical circuit made from an index card, light emitting diode (LED), wires and a battery. As the end of the white wire touches the end of the yellow wires students see the light turning on. There are also three lines with different lengths, which are drawn by a regular HB pencil. When the white wire touches one end of the long graphite line and the yellow wire touches the other end students observe the LED light turn on. Furthermore, as students test all the three graphite lines in decreasing order they will notice how brightness of LED light will increase. The HB pencil is graphite and it is conducting electricity. Shorter length graphite lines have less resistance to current flow and so the LED shines brighter.



Figure 2. Students study the conductivity of graphite, calculate the ratios between lengths of the graphite lines and compare with the brightness of the LED, and roll-up their note card to build a simple flashlight.

*Composite rocket.* The exploration of our solar system heavily depends on vehicles which are specifically designed for harsh environments found in space. One such vehicle is the space shuttle which is made from many different materials. Each of these materials serves a specific purpose to keep the astronauts inside the space shuttle safe. For example, the lower surface of the space shuttle is made from high-temperature silicone tile which protects the shuttle against high temperatures of reentry into earth atmosphere. The upper surface of space shuttle is made from reinforced carbon material to increase shuttle's structural strength for vacuum conditions in space. In this activity students build a rocket made from different materials and then launch it using a compressed air rocket launcher as shown in Figure 3. Students make their rockets from, printing paper that has already been cut into different geometrical shapes, aluminum foil, plastic wrap, scotch and duct tape. First they must build the body of the rocket by aligning and overlapping different shapes of cut printing papers over one another to make a 10" x 10" square sheet. Then they roll that sheet around the half inch PVC pipe to make a hollow cylinder. They may use aluminum foil, plastic wrap, and duct and scotch tape to re-enforce body of the rocket.

After the body is built, students then work on the cone and the fins of the rocket with the material of their choice. The challenge of this activity is to make the lightest and strongest rocket that will travel farthest in the vertical direction. Students calculate the maximum height the rocket reaches during flight using geometry. If the rocket is too heavy it will not travel far and if the rocket is too light it might not withstand compressed air pressure from the launcher. Students are given an opportunity to redesign and rebuild their rockets based on the observations of previous launches, and thus, they learn that the engineering design process is a cyclical process of design, test, and redesign.



Figure 3. Students build a composite rocket using various materials to try to make a lightweight yet sturdy rocket that will survive the launch and attain the highest point during flight.

*Hydrolysis.* One of the main reasons that transportation vehicles cannot last for a very long period of time is because they are made from metals that are vulnerable to corrosion. Corrosion in metals is a chemical reaction that turns metal into rust. Many metals corrode merely from exposure to moisture in the air. The corrosion process can also be strongly affected by exposure to certain substances such as salt. In parts of the world where salt is used to melt snow off the roads, cars are more vulnerable to corrosion. In this activity students will observe how aluminum foil and copper wire corrode through a process called hydrolysis. As aluminum foil corrodes microscopic holes begin to appear at its surface. By shining a light on one side of the aluminum foil students will observe how light passes through. Corrosion in copper wire is much easier to identify, since copper changes color to turquoise green as it corrodes and becomes thinner. Through the process of hydrolysis engineers and scientist can determine how long a vehicle can last under different environmental conditions. One way that engineers can make vehicles last longer is by replacing the metal alloy components of the vehicle by moisture and chemical resistant composite materials such as plastics. Plastics composites are highly resistant to water and many other chemicals present in our environment. After all, we buy water from grocery stores in plastic bottles and not metal.

*Molecular structure of carbon nanotubes.* Engineers and scientists use models to help them analyze the design of structures. For example if civil engineers want to analyze a new bridge design they make a microscale model of the bridge. The microscale model of the bridge allows engineers to conduct experiments on the bridge to confirm design concepts and identify any design flaws before spending millions of dollars on building the actual bridge. Scientists and engineers use macroscale models to study objects, such as molecules, that are too small to be seen by the naked eye. Single walled carbon nanotube (SWNT) is a fairly new material recently



introduced to engineering and science fields which is gaining popularity due to its strong molecular structure. In order to better understand SWNTs scientist use Scanning Electron Microscopes (SEM) and Transmission Electron Microscopes (TEM) to study the molecular structures of SWNT. Scientists then use the microscale images of SWNT to make macroscale models in order to better visualize and analyze its molecular structure.

In this activity, students design, build and analyze the molecular structure of a single wall carbon nanotube (SWNT). Students learn that the strength behind the SWNT is its molecular structure which is in the shape of a hexagon. To start out the activity, students are challenged to create a hexagon using geometrical shapes such as isosceles triangles, right triangles and rectangles. After getting familiarized with the basic SWNT molecular structure, students then learn the tools that are used to study these structures such as a Scanning Electron Microscope (SEM) and a Transmission Electron Microscope (TEM). With introduction of SEM and TEM students learn the concept of microscale and macroscale and how these concepts are being implemented in engineering and science. Next, students build a 3-D macroscale model of a SWNT molecule. As shown in Figure 4, they build their SWNT on a handout sheet where they are asked to find the area of one SWNT unit cell, the height of their SWNT model and the overall size ratio of their model to the actual size of a SWNT molecule.

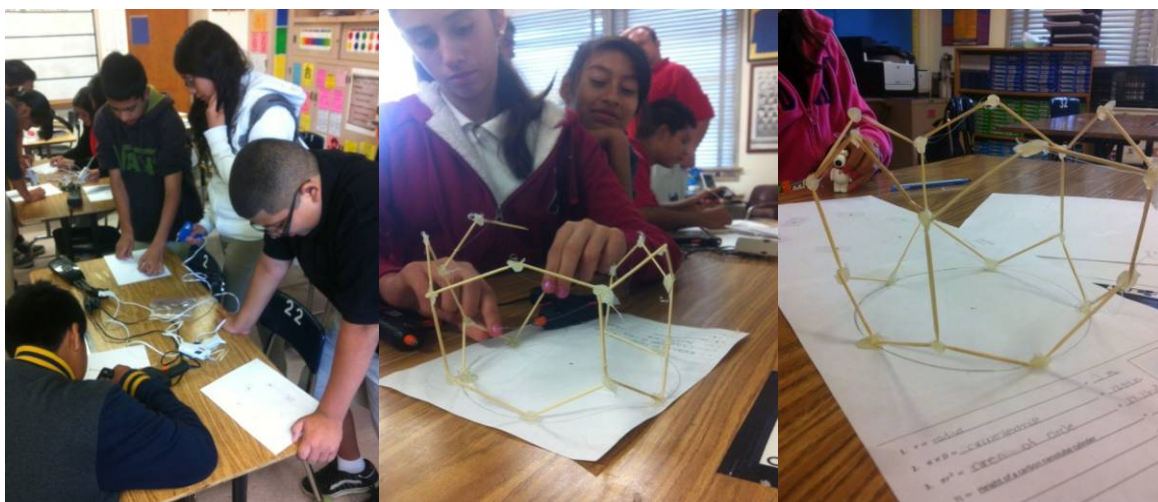

Figure 4. Investigating, building and analyzing the structure of single wall carbon nanotubes (SWNT).

### **Impact on Student Attitudes towards STEM**

Pre and post-surveys were conducted to measure the impact of the visiting engineer/scientist and the research-related activities on students' perceptions towards engineers and scientists and their desire to pursue a career in engineering or science.

*Program demographics.* During the 2012-13 school year the IMPACT LA Program partnered with three middle schools in East Los Angeles and a Math and Science High School located on the Cal State LA campus (see Table 2). Seven graduate fellows, two engineers and five scientists, were partnered with seven teachers, one math, five science, and one math/science. Looking at 2012-13 graduate fellow demographics, 71% are female and 86% are underrepresented minorities. Table 3 shows the average demographics of the four partner schools along with the specific demographics of Stevenson Middle School where the activities highlighted in this paper were conducted. At Stevenson Middle School, 99% of the students are

Latino, 87% are economically disadvantaged, 33% are English Language Arts proficient (or above), and 28% are Math proficient (or above).

Table 2. Data regarding the classrooms where IMPACT LA fellows were assigned during the 2012-13 school year including the name of the partner school, the subject matter, grade level, and the topic of the fellow's research, and number of pre and post surveys collected from students in those classrooms.

Partnership School	Subject(s)	Grade level	Fellow Research Topic	# of Surveys collected	
				Pre	Post
Alliance Marc & Eva Stern Math and Science School	AP Biology	11-12	How Wdr68 Functions in the Craniofacial Regulatory Pathway of Zebrafish	59	46
Hollenbeck Middle School	Life Science	7	The Impact of the Introduced Eastern Fox Squirrel on the Native Western Gray Squirrel in Los Angeles and Surrounding Counties	114	98
Hollenbeck Middle School	Life Science	7	Lifetime Fitness Study	110	105
KIPP Los Angeles College Preparatory School	Physical Science	8	Spinal Cord Injury and Neuromuscular Electrical Stimulation Therapy	94	87
Stevenson Middle School	Math/ Algebra/ Geometry	6-8	Developing a Carbon Nanotube Matrix to Replace Conventional Metal Alloys	131	140
Stevenson Middle School	Math and Science	6	The Development of Microfluidic Devices for Binding and Organic Studies	61	60
Stevenson Middle School	Life Science	7	The Protection of Mitochondrial Structure and Function During a Heart Attack Using the Compound Epicatechin	143	131

Table 3. Demographics of the partner school where these activities were conducted and the average of all partner schools in the IMPACT LA NSF GK-12 Program during the 2012-13 school year. ELA refers to English Language Achievement.

Stevenson Middle School	Latino: 99% White: 1%	English learners: 24%  Economically disadvantaged: 87%	ELA: 33% proficient or above  Math: 28% proficient or above
Averages Among all Partner Schools	Latino 95.25% African American: 0.5% Asian Pacific Islander: 1% White: 3.25%	English learners: 20%  Economically disadvantaged: 89%	ELA: 48% proficient or above  Math: 41% proficient or above

*Results.* The graph on the left in Figure 5 shows the percentage of students that identify science and engineering as their desired major and as their desired dream job before and after the fellow worked with them in their classroom. After participating in the program, more students wanted to study science or engineering (increasing from 39.3% to 52.3%) and more students wanted to

pursue a science or engineering career (increasing from 15.8% to 25.4%). The likely reason that more students wanted to study STEM than pursue a career in STEM is that many students want to pursue a career in medicine which we did not classify as a STEM career. The graph on the right in Figure 5 looks at the specific growth for science and for engineering in terms of desired college major and dream job. When asking students about what they would like to study in college, more students listed science and engineering related subjects in the post-assessment than the pre-assessment (increased by 12.9%). Furthermore, more students listed science or engineering related jobs as their dream job in the post-assessment (by 9.6%). In fact the estimated growth for dream jobs in engineering (8.3%) was greater than the estimated growth for science-related jobs (5.6%) which indicates a growing awareness of engineering as a profession.

While having more students pursue science and engineering majors and careers is an important goal, we are also interested in changing the perception of engineers and scientists. For this paper, we are particularly interested in discovering the impact the carbon nanotube research-related activities had on students' perceptions towards engineering. Attitudes towards engineering were sought by asking students to rank the statement, "I think engineering is fun". As shown in Figure 6, comparing the pre and post-assessment results, there was a 7.7% increase on average among the other classrooms but a 12.4% increase in the classroom exposed to the carbon nanotube composite research problem. The data in Figure 6 shows that students who conducted the activities presented in this paper and who worked with an engineer in their classroom reported that they agree or strongly agree that engineering is fun.

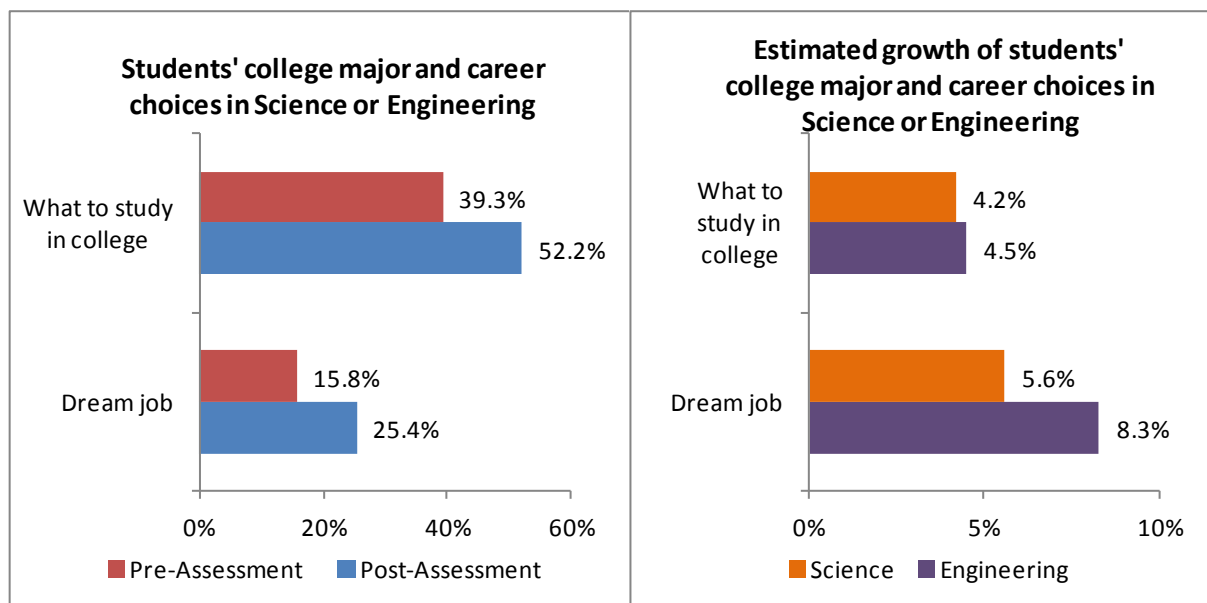

Figure 5. The graph on the left shows the percentages of students identify science and engineering as their college major and dream job before and after the fellows worked in the classroom. The graph on the right shows the estimated growth of students' college major and career choices in both science and engineering.

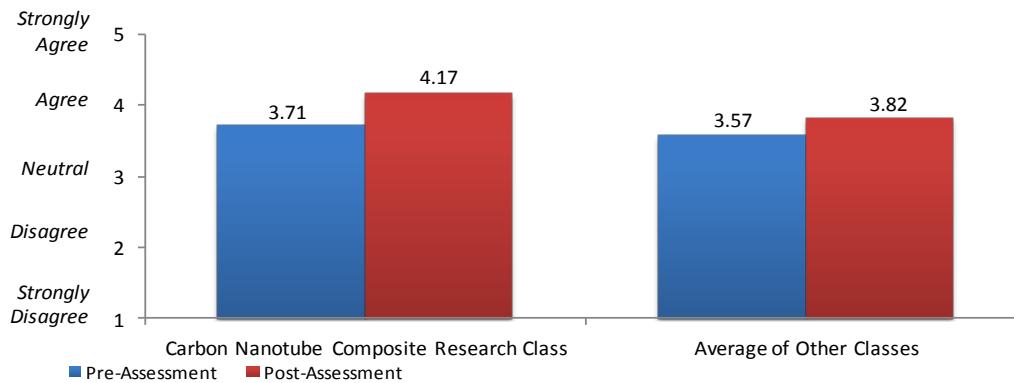

Figure 6. Survey responses to the question “I think engineering is fun.”

During the 2012-13 school year, two of the seven classes with a visiting scientist or engineering fellow were math classes. In all of the seven classes, students were asked to rank the statement “I enjoy learning math in school.” Figure 7 shows that in math classes, students sustained or even increased their interest in math whereas in the other classes, there was a decrease. There does seem to be an obvious bias towards answering this particular question more positively in a math class versus a science class as highlighted by the lower initial response in the non-math classes in the pre-assessment. Relative to their initial interest in math though, the students that were in a math class that did activities linked to authentic science and engineering research problems maintained their enjoyment of math.

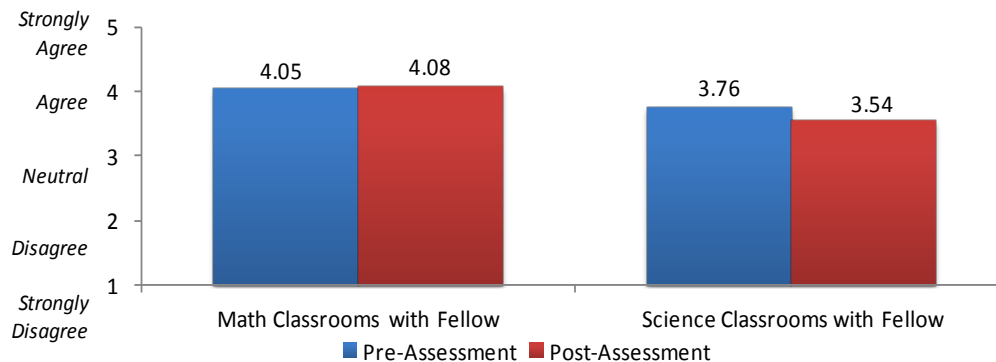

Figure 7. Survey responses to the question “I enjoy learning math in school.”

One of the goals is to increase the number of women pursuing STEM majors and STEM-related careers. Figure 8 shows the average responses by gender to the questions “I think engineering is fun” and “I think science is fun” for all classrooms with a visiting engineering/scientist fellow during the 2012-13 year. This data shows that there is a much greater awareness about what engineering is especially among girls since the growth between the pre and post-assessment for boys is 7.7% and girls is 11%. For science, the growth for boys is 7.1% and for girls is 5.9%. The larger growth for engineering is interesting since only two of the seven fellows were

engineers. The larger growth for engineering is likely due to the fact that the students are not typically exposed to engineering but in our program they either had an engineer in their classroom or learned about engineering through the IMPACT LA Open House.

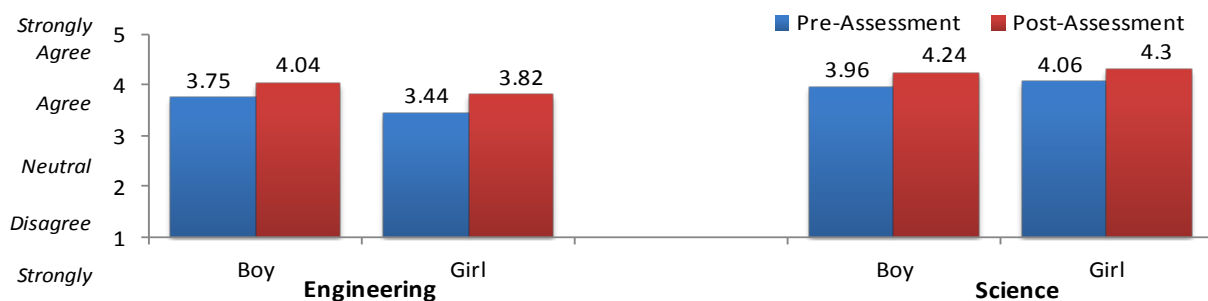

Figure 8. Survey responses by gender to the questions “I think engineering is fun” and “I think science is fun.”

To measure the impact of the IMPACT LA NSF GK-12 program on STEM literacy, we asked the students to describe “Things engineers and scientists do.” Table 4 shows that the number of students that answer “I don’t know” or that left the answer blank decreased by 8.2%. In addition, the response “Study” decreased by 10% in the post-assessment indicating that the students were more aware of the actual job of a scientist or engineer rather than simply what it takes to be an engineer or scientist. We also asked students to “List three words to describe a scientist or engineer.” As shown in Table 5, students’ perceptions of scientists and engineers improved. Students were more likely to use a positive description such as “fun/funny”, “cool”, and “awesome”. Responses such as “I don’t know”, “smart”, and “study” decreased the most. These are important results because if students have a positive perception of scientists and engineers, then even if they do not choose to study in a STEM field, they will still likely be supportive of family and friends who want to pursue STEM-related careers.

Table 4. Student pre and post responses to the question “Things engineers and scientists do”.

	Pre	Post	Difference
Experiments/ test/ research/ labs	21.6%	39.9%	<b>18.3%</b>
Life/ organism/ animals	7.8%	13%	<b>5.2%</b>
Related to fellows and their specific research	0.1%	4.2%	<b>4.1%</b>
Create/ invent something new	29.1%	30.9%	<b>1.8%</b>
Finding cures/medicine for illness/disease/bacteria	7.3%	9.1%	<b>1.8%</b>
Discover things	13.5%	10%	-3.5%
Build stuffs/ buildings/ houses/ structures, etc	31.0%	27.4%	-3.6%
Earth/ world/ nature/ environment	11.7%	7%	-4.7%
Fix/repair	10.3%	4.6%	-5.7%
I don’t know/ Blank	10.4%	2.2%	-8.2%
Study	27.5%	17.5%	-10%

Table 5. Student pre and post responses to the prompt “List three words that describe a scientist or engineer”.

	Pre	Post	Difference
Fun/ funny	7.9%	25.9%	<b>18%</b>
Cool	8%	15.7%	<b>7.7%</b>
Awesome/amazing/amusing/fascinating, etc	6.5%	9.9%	3.4%
Hard working/ hard workers/ work a lot	26.2%	28.5%	2.3%
Creative/ curious/ invent	19.2%	21.3%	2.1%
Build/ builder/ building	6%	3.6%	-2.4%

Help/ helpful/ helping	10.8%	7.5%	-3.3%
I don't know/ blank	14.9%	11.5%	-3.4%
Smart/ wise/ intelligent/ knowledgeable	70.2%	66%	-4.2%
Study	9.4%	4.6%	-4.8%

The fact that “smart” and “study” are de-emphasized in Tables 4 and 5 implies that the perceived barriers for students pursuing STEM majors and careers are lowered. This may seem an undesirable outcome to some because engineers and scientists need to be smart and study hard. But the data in Tables 4 and 5 do not necessarily imply that students do not think that engineers and scientists have to be smart and study, they instead are identifying other important attributes. To increase the number of students pursuing science and engineering careers, it is desirable for students to be more aware of what scientists and engineers do by using authentic engineering and science problems in the classroom. Furthermore it is important to have role models like the fellows with whom they can relate. In our society, people frequently interact with medical doctors, and because of that they have a good understanding of what doctors do and the impact they make on the lives of others. When deciding upon a career to study, students often do not focus on the years it takes to pursue a medical career but rather on the positive characteristics that they attribute towards doctors and medical careers. We need to be giving the same message about careers in engineering and science<sup>11,12</sup>.

### Conclusion

By exposing students to real-world engineering and science problems the IMPACT LA NSF GK-12 Program has been able to sustain their interest in math, expose them to the possibilities of careers in STEM, and increase their STEM literacy. This paper provides five activities related to research in carbon nanotubes that teachers can use in their middle school math classrooms. Furthermore, there are many other authentic engineering and science research based lessons available on the IMPACT LA website<sup>10</sup> for both science and math teachers.

### Acknowledgments

The authors would like to acknowledge that this work was done in collaboration with the 2012-13 fellows: Patricia Sanchez, Nichole Lee, Maria Ortega, Andrea Herrera, Gregory Alvarado, Janel Ortiz; the 2012-13 partner teachers: Baron You, Christine Rosser, Cynthia Godoy John Cerezo, Laura Ruiz, and Tony Semaan; the IMPACT LA evaluation team including Simeon Slovacek and Tammy Lee; and the IMPACT LA management team: Jianyu Dong, Eun-Yung Kang, Huiping Guo, and Ethan Lipton. This work is supported by NSF Grant #0742426.

### Bibliography

1. National Academy of Sciences, National Academy of Engineering, and Institute of Medicine. *Rising above the gathering storm: Energizing and employing America for a brighter economic future*. Washington, DC: The National Academies Press, 2007.
2. Gonzales, P., Williams, T., Jocelyn, L., Roey, S., Kastberg, D., and Brenwald, S. *Highlights from TIMSS 2007: Mathematics and science achievement of US fourth and eighth-grade students in an international context*. (NCES 2009-001 Revised). Washington, DC: National Center for Education Statistics, Institute of Education Sciences, U.S. Department of Education, 2008.
3. Hill, C.J., Bloom, H.S., Black, A.R., and Lipsey, M.W. Empirical benchmarks for interpreting effect sizes in research. *Child Development Perspectives*, 2(3), 172-177, 2008.
4. National Academies Press. National Research Council. *Successful K-12 STEM Education: Identifying Effective Approaches in Science, Technology, Engineering, and Mathematics*. Washington, DC: The National Academies Press, 2011.

5. The Power of Partnerships: A Guide from the NSF GK-12 Program, American Association for the Advancement of Science, Washington, D.C., 2013.
6. *The NSF GK-12 program: A decade of innovations in graduate STEM training and K-12 learning*. American Association for the Advancement of Science, Washington, DC, 2011.
7. Warter-Perez, N., Dong, J., Kang, E., Guo, H., Castillo, M., Abramyan, A., & Moo-Young, K. Strengthening the K-20 engineering pipeline for underrepresented minorities. Paper presented at the meeting of the American Society for Engineering Education, Louisville, KY, 2010.
8. Alvarenga, J., Abbott, M., Abramyan, A., Dong, J., Gontar, O., Guo, H., Kang, E., Mejia, V., Pollavith, P., Sanchez, R., Zamalloa, J., and Warter-Perez, N. "Engaging Underrepresented Middle School Students in Engineering and Science through a Two-day Summer Camp," *Proceedings of 2011 American Society for Engineering Education Annual Conference*, 2011.
9. "Mathematics » Home » Mathematics." *Common Core State Standards Initiative*. N.p., n.d. Web. 31 Jan. 2014. <<http://www.corestandards.org/math>>.
10. "IMPACT LA NSF GK12 Program." *IMPACT LA NSF GK12 Program*. California State University, Los Angeles, n.d. Web. 31 Jan. 2014. <<http://impactla.calstatela.edu/default.shtml>>.
11. *Changing the Conversation: Messages for Improving Public Understanding of Engineering*. National Academy of Engineering. Washington, D.C., National Academies Press, 2008.
12. Davis, L., and Gibbin, R., at el. *Raising Public Awareness of Engineering*, Washington, D.C., The National Academies Press, 2002.

## **Crossing the Bridge: ABET Accreditation**

Mudasser Wyne and Alireza Farahani  
National University

### **Abstract**

Accreditation of computer science and related programs has become of great importance to the academic institutions in order to ensure a higher quality undergraduate program in compliance with standards. This paper summarizes various activities and approaches that were adopted for program review and assessment by SETM leading up to the completion of the ABET self-study report for BS in Computer Science program. Some activities focused on making our onsite and online programs unique and more appealing to both traditional and non-traditional students. Accreditation is a non-governmental, peer reviewed process that ensures educational quality. Educational institutions or programs volunteer to periodically undergo this review to determine if minimum criteria are being met. Accreditation verifies that an institution or program meets the criteria, ensuring a quality educational experience. ABET accredits programs in Computer Science, Information Technology and Engineering. ABET accreditation helps institutions establish high quality programs along with processes for continuous improvements. Currently ABET is the only accrediting agency for Computer Science programs. In this paper we will examine the impact of our preparation for ABET accreditation on the curriculum as well as assessment process. We also include an overview of our assessment process, assessment instruments and curriculum changes.

### **Introduction**

National University (NU), an independent, nonprofit institution of higher education, has dedicated itself to providing educational opportunities to a diverse population of working adult learners since 1971. The School of Engineering, Technology and Media (SETM) at National University was established in July 2002, and has attracted a current student body of over 1300 whose profile generally mirrors that of the university itself. NU, the second largest private non-profit university in California, has over 23,000 mainly non-traditional students: students whose average age is over 30. The university also boasts of a large population of students from traditionally underrepresented groups, such as women and minorities. Typically, most of these students, whether at the undergraduate or graduate level, are re-entering an academic environment after having been out in the working world for some time. SETM offers nine undergraduate and eight graduate degree programs with several specializations. Over 90% of these programs are offered both in the online and on-ground modes. SETM has over 10 years of experience in online education. The undergraduate computer science program at NU was first offered in mid 1980s and since then the curriculum has been through some significant changes. The program was first offered entirely online in 2006 and currently has a strong online presence. Few years ago STEM decided to pursue ABET accreditation and mobilized faculty to examine the CS curriculum and its assessment process in order to align the program with ABET requirements.



### **ABET Criteria**

ABET provides a form of quality assurance for the undergraduate academic programs<sup>6</sup>. It consists of four accreditation commissions namely, Applied Science (ASAC), Computing Science (CSAC), Engineering (EAC) and Engineering Technology (ETAC). Each commission covers a specific sector of the technical disciplines and is responsible for policies, procedures and criteria that apply to that discipline. Commission members make final decisions about all program accreditation actions. The CSAC has two types of criteria, the “general criteria” and “program criteria” that is specific to a particular degree program. The eight general criterions address requirements related to a) Student, b) Program Educational Objectives, c) Student Outcomes, d) Continuous Improvement, e) Curriculum, f) Faculty, g) Facilities and h) Institutional Support. The program specific criteria address a) student outcomes, b) the overall curriculum and c) faculty profile. Among the CSAC policies and procedures are the requirements that each ABET-accredited program must publicly state the program's educational objectives as well as student outcomes, they must also publicly post annual student enrollment and graduation data for the program.

According to ABET, programs that seek initial accreditation must submit a readiness review report; this is a preliminary self-study report. The template for this self-study can be downloaded from the ABET site. The ABET accreditation process takes about 18 months, and it begins by the submission of the preliminary self-study report or a Request For Evaluation depending on whether the application is for initial accreditation or a renewal of accreditation. However, at least a year before formal submission, the program must have in place processes for assessing program educational objectives and student outcomes, there must also be procedures in place for collecting student sample artifacts to present to the ABET reviewing team during campus visit.

### **Preparing for the Accreditation**

The computer science program at NU is offered online as well as onsite and two the programs are identical. Contacting ABET office we were informed that we needed to submit only one self-study report for the online and the onsite programs. Among the first actions we took was to form an advisory board for the program. The advisory board consisted of five industry experts, two program alumni plus CS faculty. A mission for the advisory board was developed and periodic meetings were scheduled to discuss the program. Although the CS program at NU had a set of Program Learning Outcomes, it was decided to adapt the ABET proposed students outcomes with some revisions. A set of Program Educational Objectives was also developed by the advisory board and was integrated into the CS program and queued for assessment. The original CS program was not compliant with ABET Criterion for curriculum; it lacked math and science components. It took about a year to revise the curriculum and took it through appropriate university committees for approvals. The revisions consisted of development and addition of a lecture and lab course in Scientific Problem Solving as well as courses in Linear Algebra, Probability and Statistics, Computer Ethics, and Physics/Chemistry. The Curriculum is now compliant with the ABET criteria and will soon produce its first set of graduates.

Significant efforts were placed in development, delivery and assessment of online courses in the CS program. Online courses explicitly list Program Learning Outcomes (PLOs) or Student outcomes as ABET calls them. All Instructors are encouraged to teach and assess students

relevant to those outcomes. Online CS classes, like the onsite class, run for four weeks. All online classes are required to hold two chat sessions per week, each for at least two hour. Chat sessions are support by the voIP and application sharing systems. Faculty teaching online use tablet PCs with inking capability that facilitates a virtual environment that's very similar to the physical classroom. Online classes are highly interactive with both synchronous and asynchronous learning activities. Instructors use their tablet to deliver their lectures and conduct discussions and problem solving sessions<sup>1,4</sup>. All chat session are recorded and can be viewed by students at a later time.

### **Program Annual Review**

At NU all programs must complete the Program Annual Report (PAR) that focuses on assessing Program Learning Outcomes (PLOs) and provides recommendations on ways to improve student learning and class experience based on analyzing multiple levels of assessment measures. As part of the initial degree program design individual PLOs are mapped to required courses in the program. This course mapping also marks each PLO as Introduced (I), Developed (D) or Mastered (M) in a given course. Each PLO must be mastered in at least one course. PARs assess student learning in both teaching modalities of onsite and online. Each measure is assigned an "acceptable" and an "ideal" target level prior to the actual assessment. A student achievement on each measure is compared against the acceptable and the ideal targets and recommendations are made for program improvement. The use of multiple-assessment measures is encouraged and widely exercised at National University. Both qualitative and quantitative data collection and analysis are critical components of the PAR. Commonly used measures for assessment purpose are student scores on exams or particular questions in an exam, student portfolios, signature assignments, program exit interviews and surveys conducted of students and alumni. PAR recommendations are presented to the school dean for comments before it is forwarded to the Undergraduate Council at NU for the final review.

### **Five Year Review**

The Five-Year Program Review is a collaborative effort of the program lead faculty and faculty members who primarily teach in the program. As the name implies it take place every five years and provides an opportunity to examine historic data relevant to the program and identify trends. The Five-Year Program Review is based on inquiry where lead faculty develop a set of overarching questions that leads to program improvements. An attempt to collect evidence and respond to the overarching questions is one of the objectives of the review. External reviewer's experts in the subject are invited to review the program and provide feedback. Trend analysis of from prior PARs and comments from the external reviewers form the basis of the Five-Year Program Review. Institutional data relevant to the program such as student and faculty demographics as well as retention/graduation rates are analyzed and reported. Assessment results are compared with assessment objectives identified by the lead faculty over the five year period. The Five-Year Program Review requires faculty to reflect on factors influencing student success in the program and provide comments. The program lead and the department chair are asked to analyze student retention and graduation rates. The results from the Five-Year Program Review as well as the suggested action plans and resource allocations for the program are itemized in a Memorandum of Agreement that requires approval by the school Dean and Provost.

### Assessment Methods

The assessment plan includes direct and indirect measures for evaluating the achievement of program learning outcomes. Each PLO requires two direct and one indirect measure for the purpose of triangularization.

- **Direct measure** – Individual items imbedded in course assignments or exams are used to assess specific program learning outcomes. The Program Lead faculty and the individual faculty member teaching the course will develop the items. PLOs are assessed at key points in the curriculum to determine the level of learning (Initial, Developed, Mastered).
- **Indirect measure** – Upon completion of the program students participate in an exit survey in which they are asked to rate themselves on the achievement of PLOs. This affords an opportunity to evaluate the extent to which students have acquired the skills and knowledge outlined in the program learning objectives. Periodic surveys in individual classes provide more focused data collection.

### Assessment Process

In general, the purpose of assessment at National University is to continually improve and ensure the quality of the programs, assessment also aids in allocating funds and other resources within the school. Since assessment is handled at various levels, it is critical to have a solid assessment plan that effectively evaluate success and allow for the assessment to be completed within time. It should also provide information on student accomplishment in the program.

The assessment process for our programs is handled at various levels and by different committees consisting of faculty and administrators. Assessment starts with the program lead, who is a full-time faculty responsible for the curriculum content and its relevance and quality. Lead faculty is given other critical duties such as staffing classes, review faculty evaluations and student assessments, initiating curricular changes to name a few. Lead faculty reports to the department chair and require chair's approval for curricular decisions. Program lead faculty develops (multi-year) assessment plan and produces the annual PARs. The lead faculty is also given the task of planning and completing the Five Year Program Review. Members of the School Assessment Committee (SAC) provide assistance and coaching to the lead faculty in the preparation of the various components of their PAR for their programs. The PAR reports are entered and archived in a web accessible central system known as Task Stream Accountability Management System (AMS). In 2008, National University acquired the AMS system to support the assessment process. AMS provides a mechanism for tracking recommendations and action plans recommended for a program. The Curriculum Map, Multiyear Assessment Plan, as well as all assessment findings and recommendations are archived in the AMS system. SAC coaches inspect the content and completeness of the PAR on the AMS and provide feedback to the lead faculty, which is entered in the system. The completed PAR is then reviewed by the department chair and school Dean. The PAR is next submitted for approval to the Undergraduate Council that has its own Assessment Committee that review PARs and add comments and assign a score (Initial, Emerging, Developed or Highly Developed) based on the rubric provided for each section in the PAR. The chair of the committee then presents their findings to the Undergraduate Council and seeks Councils approval. Figure 1 show the cycle each program PAR is routed through.

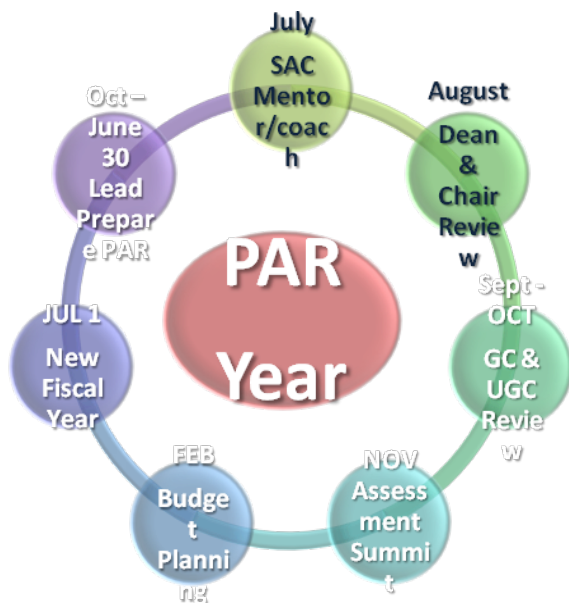

Figure 1. PAR review cycle.

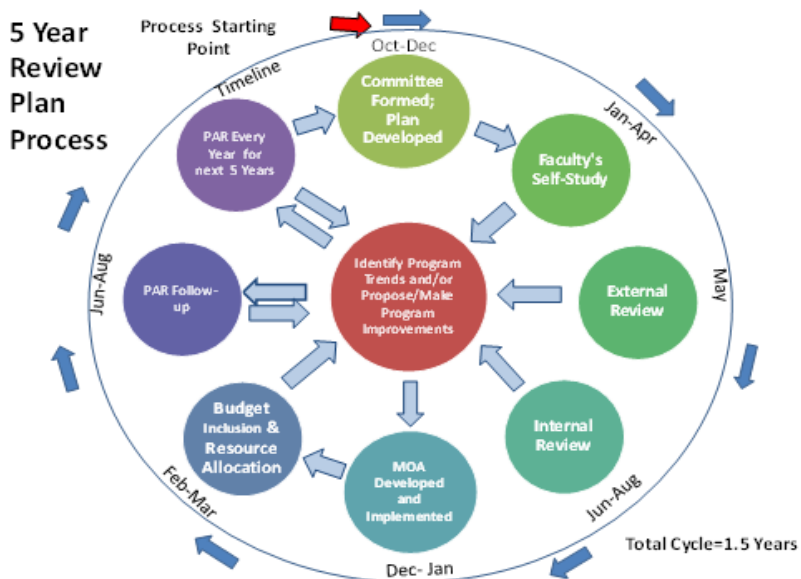

Figure 2. 5-year review cycle

A five-year program review process goes through the same review and approval process as PARs. Figure 2 shows the cycle for a typical Five-year Program Review cycle. The advantage of the National University assessment cycle is that it:

- Exists in relationship to the Mission, Core Values, Strategic Planning, Five Year Program Review, and the Assessment Summit.
- Evolves as a systematic yearly planning and review process consistently used by all schools and departments.

- Contributes to a comprehensive, University-wide approach to assessment. Multiple methods of data collection and analysis of student learning are used to assess progress towards achievement of learning outcomes and to make informed decisions regarding change.
- Provides for regular and ongoing opportunities for faculty engagement and reflection based on learning results.

### **Presentation of Results**

The PARs include analysis results and comments viewable by all program faculty, administrative members as well as the members of the Undergraduate Council. The University implemented Taskstream's AMS system as a collaborative work environment and a repository for recommendations from preceding years. Assessment data, analysis, findings and recommendations for each program are presented at the Annual Assessment Summit held at NU where the NU community gathers to present, discuss and learn about all aspects of assessment.

In a recent Assessment Summit the CS program presented its Alumni survey. The survey was conducted by the University's Office of Institutional Research and Assessment (OIRA). The most recent survey in CS was conducted in June 2010, this was a 13-item survey. The survey questions were internally created in the department and were designed to collect data on items relevant to ABET accreditation. Survey mailing and administration as well as report generation were all conducted by the OIRA. The 2010 survey was the first formal survey of graduates conducted in our department to gather information on the student experience at NU and the level at which program educational objectives were achieved. The initial levels of attainment for educational objectives were set at 70%. Results of the 2010 graduate survey indicate that 88% of the graduates were employed in a computing field. About 23% of the students had membership in some professional organization. About 27% of the graduates were involved in community service activities. And finally, about 23% of the graduate stated that they received some noteworthy recognition or award since graduation. The survey results were shared with the program advisory board members and it remains archived as assessment document for BSCS program.

### **Assessment Instrument**

NU's Assessment process consists of PAR that is completed every year and a program review that is done every five years. About 20% of the PLOs are assessed each year; the idea is to assess all the PLOs by the time a five year review is to be conducted. The NU standard for assessing a PLO is to use two direct and one indirect measure. The standard also requires the program lead faculty to establish a baseline by stating the "acceptable and ideal target" in terms of student performances. Supporting documents, mostly consisting of student artifacts, are collected as evidence of student success. The assessment planning requires a "Multi-year Assessment Plan" indicating when and in which course each PLOs is to be assessed in the coming years. "Assessment findings" is also a part of each PAR, it details findings for each outcome. Other sections of PAR include Overall Reflections, Implementation of Changes from the Last Program Assessment and Implementation of Changes from the Last 5-year Review. The last section in PAR is the "Overall Recommendations and Requests for Resources". The last two items are, basically, an attempt to close the loop for the assessment cycle and to initiate implementation of approved changes, if any.

A major effort goes into completion of Five Year Program Review. The report is produced by a committee of faculty who teach in the CS program. The report starts with a section on “General Information” about the program that includes a timeline for the “Assessment Plan”. The plan details actions to be taken and tasks to be completed, individual committee members are given different responsibilities leading to the collection of assessment data, its analysis and final reporting. The Five Year Program Review is examined by two external reviewers that are invited by the lead faculty to review the report and provide feedback. The reviewers are subject matter expert. The Five-year Program Review consists of 12 sections in total. There is a section that provides detailed information about the program as well as sections about the relevancy of the program, the currency of the program, faculty qualifications, their preparedness and academic support, student achievement, academic success of students, program vitality, adequacy of resources, additional information, summary of recommendation, and the report from the external reviewers.

### **Monitoring Student Performance**

The academic progress in the program is assessed by the cumulative grade point average (GPA) achieved at National University. A student must maintain the minimum GPA of 2.0 to make satisfactory academic progress in the program. Students whose cumulative GPA falls below 2.0 are placed on academic probation. The chair and the lead faculty for the program periodically receive a list of most recent students placed on the probation. Student progress is also monitored by their admission advisor assigned to them when they enroll in the program, and the lead faculty for the program. As students make progress through the program, the Annual Activity Report (AAR) will show coursework already completed and courses remaining to be completed. The AAR helps students, advisors, and the registrar office determine progress toward the completion of program requirements and also serves as a graduation check. The lead faculty reviews students’ schedules and course grades on a quarterly basis and contacts appropriate admission advisors if adjustments are needed.

### **Student Advising**

Upon admission to National University each student is assigned an admission advisor that advises the student on University policies as well as assisting them on planning a course of study for the entire program. Admission advisors are trained on all university programs and understand the requirements for individual programs. Each student also has an academic advisor who is the lead faculty for the program. Admission advisors continue to advise students as they go through the program. Students often contact their admission advisor when they need assistance or clarification of certain rules or regulations; often admission advisors submit requests (for example, an independent study request) on behalf of students for approval. The request is submitted electronically (e-form) through SOAR. Admission advisors are available during normal business hours, students can either make an appointment to visit their admission advisor or contact them via email or a phone call.

Upon admission to the University, students may contact their lead faculty to assist them in making appropriate decisions about their educational or career path. The lead faculty provides students the benefit of experience in professional practice and insight gathered from years of experience in the industry and/or in higher education. The lead faculty for the Computer Science program reviews student grades and their plan of study on regular basis to make sure they are

meeting all program requirements and are on track for graduation. Lead faculty advise students on curriculum content, course requirements, proficiency examinations, and program goals. Student schedule and grades are available to the program lead electronically through SOAR.

The initial set of Program Educational Objectives was derived from the mission of the University, Program Learning Outcomes, and Institutional Learning Objectives. The proposed objectives were recently reviewed, discussed and approved in the Program Advisory Board meeting on October 2011 consisting of industry experts, faculty and graduates of the program. Our plan is to examine the current set of objectives every two to three years in the Advisory Board meetings. The survey results from our graduates along with our industry advisors will play a major role in guiding future additions/deletions or revisions of the program educational objectives.

The eight PLOs in the computer science program embody the knowledge and skills expected of our graduates immediately after graduation. To ensure graduates have adequate opportunities to master student outcomes, the PLOs are mapped to individual courses on a Curriculum Map. Each course in the CS program has a set of learning outcomes that address one or more of the PLOs. The CS program has a Multiyear Assessment Plan that gives a list of PLOs to be assessed each year and the courses to be used for their assessment. The assessment plan also specifies the instrument(s) to be used for assessment. The assessment plan, its findings and recommendations are documented and reported annually in a Program Annual Review (PAR). The PAR reports are entered and archived in a web assessable central system known as AMS (Task stream Accountability Management System). In 2008, National University acquired the AMS system to support the assessment process. AMS provides a mechanism for tracking recommendations, action plans, and results from year to year. The Curriculum Map, Multiyear Assessment Plan, as well as all assessment findings and recommendations are archived in the AMS system. The PAR report is reviewed by the Chair and school Dean, and the University Assessment Committee.

The one course per month nature of the National University (accelerated format) provides opportunities to assess student learning outcome on regular basis multiple times per year given the availability of time and resources. The Computer Science department is still trying to find the optimal frequency for assessing PLOs. Currently we assess each PLO at least once for each cohort of students that go through the program. At any given time, there are from two to four cohorts of students at different stages of the program; this includes the online cohorts as well. The summary of the assessment results are presented in this section.

As a baseline we have decided to set the expected level of PLO attainment for each student at 70%. We plan to gradually increase this level. Recent assessments have produced Introduction of Smarthinking online tutorial in courses with mathematics content – University allocated close to \$10,000 to contract Smarthinking online mathematics tutorial for our students. The rationale was to help improve student performance in mathematics classes. Many of our students enter the program with weak math skills and perform poorly. Many drop out of the program due to weak performance in mathematics (and programming). SETM decided to provide a free online tutorial for students taking mathematics classes. Unfortunately the approach was not successful; the tutorial was not popular with students. The reason could have been the text based chat system. No formal study was done to find out why the tutorials were not successful. Review of

simulation software for CSC340L – Digital circuit lab resulted in a change. The Xilinx software proved to be too complex and overwhelming to be utilized in our classes. The simulation tool was replaced by MultiSim from National Instrument. Providing free tutorials for all 200 level CSC courses – we have received approval to experiment with providing tutorial session for our students. The object is to have either graduate students or our adjunct to be available to help students in lower level CS classes.

### **Conclusion**

This paper provides a summary of approaches adopted by SETM from the design, development and implementation of assessment plans for its CS degree program to prepare the program for the ABET CS accreditation. Steps taken to make the program compliant with ABET criteria are presented and some factors to enhance the online program are discussed.

### **Bibliography**

1. Uhlig, R., and Viswanathan, S. (2006). *Effective design, instruction and assessment of an on-line engineering course*. Presented at the ASEE Mid – Atlantic Conference.(28-29) New York City, New York.
2. Koile, K. and Singer, D. (2006). *Improving learning in CSI via Tablet-PC-based in-class assessment*. Proceedings of ICER (Second International Computing Education Research Workshop). Canterbury, UK: University of Kent..
3. Kowalski, F. Kowalski, S. and Hoover, E. (2007). *Using InkSurvey: A free Web-based tool for open-ended questioning to promote active learning and real-time formative assessment of Tablet PC-equipped engineering students*. American Society of Engineering Education Annual Conference & Exposition, Honolulu, HI
4. Uhlig, R.P., Farahani, A. and Viswanathan, S. (2011). Enhancing learning and engagement in engineering classes. *The Technology Interface International Journal*, 11,(2), 24-35.
5. Reeves, J., Amin, M., Turqueti, M. and Dey, P. (2012). Improving laboratory effectiveness in online and onsite engineering courses at National University. *Journal of Research in Innovative Teaching*, 26-38.
6. Accreditation Board of Engineering and Technology. (2013). <http://www.abet.org/>



## **Green Energy Conference Experience – Integration of Class Room Research Projects to IEEE Professional Presentation**

Hen-Geul Yeh, Duc Tran, and Paula Quintana  
California State University, Long Beach

### **Abstract**

Green Energy is a typical multidisciplinary and interdisciplinary topic for researchers, practitioners, faculty and students. In general, energy generated from the combustion of a limited supply of fossil fuels presents environmental concerns. Renewable energy, such as solar and wind, dramatically lowers CO<sub>2</sub> pollution emissions, reduces environmental health risks, and slows down the depletion of finite natural resources. On the other hands, the cost of renewable energy generation is relative high. From an engineering and economic point of view, there are many open challenges for research and development in order to accelerate the renewable energy deployment with lower cost. In response to the need, the systems council Chapter of the Coastal Los Angeles Section (CLAS) of the Institute of Electrical and Electronics engineers (IEEE) has held one-day conferences since 2010 at California State University, Long Beach. This conference brings together researchers, practitioners, faculty and students from relevant fields to present and disseminate ongoing research for green energies and their associated technologies. This paper describes a unique multidisciplinary engineering conference program that brings together faculty and their students within a one-day program called, the “IEEE Green Energy and Systems Conference” (IGESC). A study, along with observations made before, during, and after the Conference offered preliminary findings regarding faculty and student’s perceptions of different projects influencing student research and career choices.

### **Introduction**

In the present global energy and environmental context, the aim of reducing the emissions of greenhouse gases and polluting substances has become primary importance. Transforming from using fossil fuel to green energy for a better environment is the top issue on the world today. Renewable energy or green energy is energy that is produced in a manner that has less of a negative impact to the environment than energy sources like fossil fuel which often produce harmful side effects. Types of green energy that often come to mind are solar, wind, geothermal and hydro energy. In fact, it is a significant area for the investment, and the ability to develop technology that harnesses energy from wind, solar, water and other renewable resources defines future generations of technology. The engineers and scientist who are solving these challenges today are using many advanced technologies to develop and deliver tomorrow’s solutions for a sustainable environment. These technologies definitely need to be widely spread and fully understood by young generations so that they can develop and apply them in the future.

As a matter of necessity, the systems council Chapter of the Coastal Los Angeles Section (CLAS) of the Institute of Electrical and Electronics Engineers (IEEE) has held one-day conference IGESC since 2010 at California State University, Long Beach. The objective of this conference is to foster idea exchanges for green energy production, smart power transmission,

distribution, and usage in homes, businesses, and vehicles. It also provides a broad scope of the strategies, procedures, and techniques required to properly integrate the various aspects of emerging green energy technologies. Through the experiences of two graduate students who have attended the conference, this paper describes their study, along with observations made before, during and after the conference, and how the conference have influenced their research and career choices.

## Testimonies

### *Electrical Engineering Graduate Student #1, Emphasis: Communications*

*Multidisciplinary project-based learning in the classroom.* I got the invitation to participate in the IGESC 2013 during the first lecture of the class Advanced Digital Signal Processing (EE585). The professor of the class motivated us to be a part of this conference, and mentioned that students could submit papers and compete in a poster session at the conference. I had never participated in any event quite like IGESC, therefore I thought of this conference as a good opportunity to learn and network with other students and professionals in engineering.

My first obstacle, however, was to choose a topic for the paper. My emphasis in the EE master's program at CSULB is communications, a field in which I had never really studied anything related to green energy. I was troubled because I really wanted to come up with a good innovative idea to participate in the conference, but I realized that I hardly knew anything about green energy. I thought my best shot was to search on green energy topics that had some relationship with my emphasis. After of couple of days reading papers at the library, I became somehow desperate. I was overwhelmed by the amount of information available and its complexity. For some papers, I had to review multiple concepts in parallel to understand the general idea being presented by the authors, making it hard for me to have the confidence to choose a good topic to write about. On the next lecture, my professor decided to assign a project for the class on "Power Flow Optimization in Distribution Networks". He mentioned that if we did a god job on the project we could use it to participate in the conference. The project comprised subjects that I was not familiar with, but I thought it was a good option, considering I have not decided on a topic for the conference yet. I also felt more confident about working on this project because I would have the support and guidance of the professor, who is an expert on the topic.

After reading several papers, and learning about convex optimization, smart power grid, photovoltaic cells and software tools to run simulations for the assigned project; I turned it in for the class. As an expert in the field, my professor noticed that the approach that I used to solve the problem presented in the project guidelines was innovative and valuable, so he motivated me to improve some aspects of it before I submitted it to the IGESC. The process of learning about a multidisciplinary topic through a research project for one of my classes is one of the most valuable experiences that I have had during my graduate studies at CSULB. By having the opportunity to participate in the IGESC with a paper, I was motivated to learn about green energy applications, challenges and systems; and to integrate my skills in engineering with the new knowledge acquired to generate innovative ideas.

*The IGESC experience and observations.* The day of the conference I set up a poster for the paper on “Power Flow Optimization”. My project was about the optimization of VAR control methods for distribution networks with photovoltaic (PV) generators. The main idea of the project is to use power from PVs along distribution networks to minimize the overall power loss. PV inverters are introduced as low-cost devices that can replace voltage regulation technologies currently used in these networks, such as shunt capacitors and ULTCs (Under Load Tap Chargers), with faster response times that allow them to be used as VAR controllers. VAR controllers powered up by green energy sources such as PV inverters reduce power consumption and losses from non-renewable energy sources and use green energy sources instead to supply for the power demand of the network. Reducing the power loss accounts for an improvement of the power distribution efficiency and this translates into money and non-renewable energy savings (Yeh, 2012).

During the morning, different professors and students came by to read my poster and asked questions about it. I was very pleased sharing my work with people from different engineering departments. One of the greatest challenges I encountered presenting my poster to the public, was to explain the contents and achievements of my project to people from engineering departments different than electrical engineering. The presence of a diverse audience makes the interchange of ideas richer, however it requires further explanations of terms, concepts and systems studied in more depth by electrical engineers. I managed to keep the objective of the project as simple as I could during the introduction and I would gradually get into details regarding the mathematical derivation and results depending on the interest and retention of the audience. I think this experience helped me develop communication skills that are valuable for future professional presentations in my career as an engineer.

My poster was evaluated by engineering CSULB faculty who serve as conference student paper assessment committee. Each member from the committee came at different times during the morning to ask me a set of questions about my project and poster. I felt very confident about my work, so I made my best effort to explain every aspect of it. During the poster session, I made some time to go visiting other fellow students who were presenting their projects as well. It was interesting for me to notice that there were at least other three students from my same EE585 class. It became clear to me that the professor made a good job motivating the students to participate. After the poster session I stayed until the end of the conference and listened to the speakers that presented their work during the afternoon. From all these presentations I was able to gain a better understanding of the green energy field and its different applications. Topics would include renewable energy sources, smart power grid, electric cars and efficient battery types. By the end of the day, the IEEE Systems Council Chapter, Coastal Los Angeles Section gave participation diplomas to all students participating at the student poster session. They also awarded the three best posters. I was awarded with the first place.

*Consequences and accomplishments of the IGESC.* For me as a student, the IGESC was an opportunity that allowed me to relate with other professionals in engineering and to learn from the green energy field. Winning the first place award in the poster session gave me motivation to keep working with my advisor on the project presented. We are currently writing a professional paper for submission to the IEEE. The experienced and knowledge that I gained in green energy and power systems through this conference allowed me to consider more work options, since

now I have some background in those areas. That is a very important consequence for me, since I will graduate soon and looking for a job is one of my priorities. Additionally, I was able to add my experience in the IGESC as part of PhD applications for different schools.

*Electrical Engineering Graduate Student #2, Emphasis: Power Systems*

*Multidisciplinary project-based learning in the classroom.* IGESC could be considered one of the most important annual events of EE department at CSULB. It not only has been announced by all of the EE professors in their classes, but also has been advertised to other universities. The tangible objective of systems council Chapter of CLAS when hosting this conference was to create the change for students of CSULB and other campuses to gain knowledge about smart grid and renewable energy through the presentations of speakers from academia and industry; as well as to widen student's connection through communicating with other people. Before the conference, professors during their classes always encourage their students to attend the conference and participate in the student poster competition if possible. This somehow passed the excitement and enthusiasm to the students, and they waited for it eagerly.

As an EE graduate student at CSULB, I realized IGESC was very important for me not only about my advanced knowledge, but also about my future career. I have decided to attend the conference as well as participate in the student poster competition. Participating in a professional conference like IGESC required a careful preparation for my project. I have chosen the topic that relates to renewable energy, and discussed it with my advisor and other professors at CSULB many times during the year to get their best advice for the project's solution. Through that interactive process, the solution of my project has been reinforced and gotten better day by day until it has been achieved. The project that I used to compete in the student poster session in IGESC 2011 is "A survey on solar inverters". Basically, the sun is certainly a renewable energy source with great potential and environmental friendly. However, this type of sources supplies dc power while the present power grid accepts ac power only. Therefore, dc-ac grid-connected inverters are necessary for power conversion. It is the fact that the production of electricity from photovoltaic (PV) systems is still expensive, when compared to conventional production methods. This fact necessitates the careful selection of each individual part of a grid-connected PV plant in order to achieve maximum energetic and economic performance (Demoulias, 2010). Sizing the optimum inverter reaching consumer's electrical needs is one of the most important things that have to be considered firstly. In my project, an investigation on inverters efficiency was performed based on the observation that the PV efficiency curve shape can be described by a function based on three parameters, determined from data provided by the manufacturer. Then an analytical method for the calculation of the optimum inverter size in grid-connected PV plants in any location, which can be a valuable tool for comparing different inverters without having to perform multiple simulations, is presented.

*The IGESC experience and observations.* Attending IGESC helps me feel integrated with the academic community. It was great to be in the IGESC, to meet other students who are also interested in green energy and associated technologies, and to discuss theoretical and methodological ideas. I loved the wonderful presenters for each session, especially about green energy production, smart power transmission, distributions, and usages in homes, business and vehicles. They were all informative, professional and approachable. I feel that my excitement and pride in being an electrical engineering has been renewed. The greatest experience I have

encountered during IGESC is when I was presenting my project's poster to students, professors and experts. It was really great when they all listened to my presentation, gave comments and encouraged my work. Participating in the student poster session served as an effective motivator for me to tackle the next research obstacle, as well as helped me encounter the condition of working under pressure. This competition provided an excellent way for me to set deadlines for myself to accomplish my research between demands of classwork, teaching assistantship and family obligations. My project's poster has been awarded as the second place in the student poster session in IGESC 2011.

*Consequences and accomplishments of the IGESC.* The number of attendees of IGESC 2013 was about 220, which is a remarkable increasing from IGESC 2011 and 2012 (about 120 to 150 attendees). This shows that IGESC has certainly built its prestige year by year to attract more people not only from academia, but also from industry. Even though my emphasis was in communications, I changed it to power systems since I realized that green energy and associated technologies is an emerging topic for engineers. There certainly will be a big job market for engineers who work in these fields for the next 20 to 30 years.

The objective of this conference was incredibly positive and encouraging: fostering idea exchanges, providing strategies, procedures, and technique required for integrating emerging green energy technologies, and creating an engaged, interactive community of technical professionals from both industry and academic sectors. I believe that students leave the IGESC feeling empowered, inspired and motivated, and bringing home a lot of information with them. Dr. Sergio Mendez, a Chemical Engineering professor at CSULB and one of the IGESC conference steering committee members, said: "Green energy is growing. We're not using many green methods to generate green power but that is changing. A growing field means jobs. One of the goals of Engineering Department is to encourage students to commit themselves to lifelong learning. We want them to leave the classroom and learn something for their professional advancement. That is what they will find at the conference" (Manly, 2013). This idea has been being the decisive factor of the conference since 2010.

## **Conclusion**

Through the experiences and observations made before, during and after the IGESC of two EE graduate students at CSULB, the impact of the conference to students have been pointed out. The most important advantage of this conference is that it offers a great opportunity to engage student's participation through a professional society that directly enhances classroom research projects and career explorations with faculty advisors. The conference has been successful in exposing students to multidisciplinary research in the area of green energy, as well as, enhancing student's presentation and writing skills. Results showed that over half of the faculty discussed the research projects and careers with their students in engineering classes. Students can then become advocates for their own academic growth in a green energy area. Additionally, it has been a faculty-student effort to spread the word about this conference in their classrooms and to integrate green energy approaches and applications into their syllabus, as a way to provide students with guidance in the development of good quality papers and a better understanding of multidisciplinary fields in engineering.

As for future IGESC sessions to come, the involvement of new faculty and student members is crucial to expand the scope and impact of the activity. Advertisement of poster session prizes could work effectively to motivate more students to participate, as well as poster funding for best papers submitted. The IGESC's topic will be updated each year. The IGESC 2014 will focus on renewable technologies for the electric distribution and the smart home, and it will cover both theoretical and applied aspects. This topic changing is the key for the attendees to catch-up the emerging and innovative ideas, as well as the key for the continued development of new technologies. By investing in fostering and developing, the IGESC not only helps engineering students to stay at the forefront of emerging technologies, but also helps them become leaders in the development of technologies.

## References

1. H. G. Yeh, D. F. Gayme, S. H. Low "Adaptive VAR Control for Distribution Circuits with Photovoltaic Generators," IEEE Trans. On Power Systems, Vol 27, No. 3, August 2012.
2. C. Demoulias, "A New Simple Analytical method for Calculating the Optimum Inverter Size in Grid-connected PV Plants" Electric Power System Research, vol. 80, Issue 10, pp. 1197-1204, October 2010.
3. R. Manly. (2013, Nov 15). Energy Conference Returns [Online]. Available:
4. <http://www.csulb.edu/misc/inside/?p=44313>

## DeBugger Game: Mobile Virtual Lab for Introductory Computer Programming Courses

Ilmi Yoon, Eun-Young Kang, and Oh-Young Kwon  
San Francisco State University/ California State University, Los Angeles/ Korea Tech

### Abstract

This paper introduces a Multiplayer Online Role Playing Game (MMORPG) named *DeBugger*. The game is developed based on several significant findings about MMORPG games in order to teach introductory Computer Science programming more effectively and provide more exciting learning experience to students. The DeBugger provides a collection of educational mini games within a virtual community of learners where players engage in fighting with bugs, defeat them by solving programming problems, keep track of their scores, manage their characters, and interact with other players to build relationships. The game is implemented to utilize addictive and compelling aspects of MMORPGs such as scoring system, beating the game, role-playing, and online relationship, to retain players longer, promote players to solve more quests, and encourage players to discuss and learn from each other more actively. The game allows the instructor to create a virtual lab to promote peer learning and tutoring. In a virtual lab, players can encounter peers who can teach each other or TAs who can provide more guided help. The game can be run on mobile devices as well as a desktop computer so that students can continue to play the game at their convenience and painlessly increase learning hours. The game is designed to be used as a supplementary lab tool rather than a primary teaching tool. Considering that awareness of importance of early programming exposure to high school or even middle school students has increased, developing publicly available multiplayer online educational games for CS students is a seemly and timely sought effort. A positive efficacy testing of the DeBugger on learning and social interaction among students is discussed in the paper.

### Introduction

It is widely accepted that programming is very difficult to learn<sup>1</sup>. For example Bergin and Reilly noted that it is well known in the Computer Science Education (CSE) community that students have difficulty with programming courses which can lead to high drop-out and failure rates<sup>2</sup>. The concepts in CSE are non-intuitive or/and overwhelming. Students need to solve a lot of exercise problems to digest the concepts, with close interactions, guidance and help when they are lost. Average pass rate for CSE course at colleges across US is around 60%<sup>3</sup>. Considering that significant shortage of workforce in CS<sup>4</sup>, it is imperative to develop and provide publicly available and effective educational tool to help students as well as instructors.

Recent computer science education that strongly recognized the significance of abundant exposure at an early age in improving one's computational thinking and problem solving approach<sup>5,6</sup>. Similar to Algebra, for example, where concept of variables in algebraic expressions takes some exposure time to get familiar to most 5-7th grade students, concept of variables in programming language also takes some time to become familiar and comfortable to college students. Moreover, to develop computational thinking for programming in addition to learning core concepts (variables, data types, conditional statements, etc.), students, whether young or not, usually need to go through many exercises and, to some degree, repetitive practice. To shorten the learning curve and to make the iterative learning process entertaining while increasing

exposure time effectively, game-based learning tools can be an effective aid for computer education.

Game-based learning has been an active area of educational research with hopes that playing game would effectively aid students' learning. A large number of studies have shown the educational impact of the game-based approach<sup>7</sup>. Challenges of educational games are not that they are not educational enough, but that they lack of entertainment and fail to retain players enough to deliver the intended educational impact. The good news is that these studies have shown significance of social interactions in the game to retain players longer. Figure 1 shows the general play time of stand-alone game vs. MMORPG game; games with social interactions keep players longer over time<sup>8</sup>. Popular MMORPG games tend to retain their players for a very long period time (months to years) and allow them to invite friends to play together (spread through human network). Recently, Farmville, a relatively simple farm nurturing (crops or farm animals) Facebook game made a nice showcase of how quickly a game can spread through social interactions (80 million active players) and keep players playing repeatedly.

<i>Hours per week</i>	<i>MMORPG players</i>	<i>Non-MMORPG players</i>
0–1 h	1%	11%
1–2 h	5%	38%
3–6 h	10%	35%
7–10 h	13%	7%
11–20 h	25%	2%
21–40 h	34%	4%
40 or more h	11%	2%

Figure 1. MMORPG vs. non-MMORPG games, hours played by players; Source: Addiction to the Internet and Online Gaming. 70% of MMORPG players spend more than 10 hours per week to play their games while only 16% of Non- MMORPG players spend more than 10 hours.

Popular MMORPG games like World of Warcraft has several millions players. A lot of researches have analyzed the main driving factors<sup>9,10</sup>. These studies pointed out that players especially enjoyed the fact that there is a community of audience to give compliments when a player achieved high level or completed a quest. It is an important finding which can significantly increase educational games' efficacy. Educational games that are well designed for good educational impact often suffer from the fact that players do not play voluntarily over and over. Another strong trend of young generation is continuous usage of smart phone at all times and playing rather simple games for killing time.

MOOC (Massive Open Online Course) is one of noticeable approach in recent education. Among many computer science courses, introductory computer science course (CS1) has become pilot course for MOOC and diverse approaches are being explored. However, majority of these approaches focuses on lecturing mechanism and interactions between the instructor and students even though peer interactions have served important roles for learning explicitly or implicitly<sup>11,12,13</sup>. As much as effective instructor-student interactions are explored for MOOC, similar effort should be made to explore and develop means to improve peer interactions. The



MMORPG game, “DeBugger” was designed and developed to make use of these findings to assist Introductory Computer Science course. In the game, players engage in fighting with bugs, defeat them by solving programming problems, keep track of their scores, manage their characters, and interact with other players to build relationships. Also, the game enables the instructor to create a virtual community (virtual lab) where students can meet each other and play collaboratively or competitively via educational game challenges. Mobile DeBugger game is created to take advantage of this mobile trend, to encourage students to connect to other players, and seamlessly continue playing DeBugger game while students are away from the computer.

### **DeBugger Game**

The DeBugger is a MMORPG game where there is a persistent virtual world that continues to exist and progress even after a player exits the world (i.e. stop playing the game). In that world, players are represented by their characters with status properties like game level, virtual money, health, list of friends, and game items like weapons or tools. Design principles of the DeBugger game are:

1. Make use of players’ attachment to the character. In commercial MMORPG games, players have shown strong attachment to their online avatar (or their own characters). To be able to level up their characters, players can enjoy irksome process –known as boring, time consuming and repetitive tasks<sup>14</sup>. Players happily spend hours and hours to succeed in a quest. While there is pleasure of succeeding in quests itself, players are strongly motivated by the fact that their successes in quest result in level-up or acquisition of special awards and recognition in the community. Therefore, to level up characters in DeBugger, players are often observed to play DeBugger longer with focus to keep their rank high.
2. Studies have shown that students learn from peers as much as from teachers<sup>15,16,17,18</sup>. Students tend to ask questions for clarification among peers first and then ask questions to the teacher if no answer can be found among their peers. In addition, peer pressure pushes students not to be left behind. Online game communities have shown that experienced players take great pleasure helping novice players. These advanced players can be further motivated to help new players like a TA giving close individual interactions that teachers may not give in real world. Frustration from the learning can be alleviated by sharing the similar troubles of individual with peers. Peers can be connected in the virtual world, available when needed, and increase educational impact.
3. For timid students, they can hide behind their virtual character, to avoid the fear of failure.
4. Importantly, typical MMORPG games advance and adjust depending on the needs or demands of the player community unlike console games that have pre-fixed settings once manufactured. The DeBugger game can advance and adjust the same way. In addition, the DeBugger can collect through the game server, a massive amount of educationally meaningful data based on the players’ activities. These data can be useful for iterative design cycle (design, development, user test) of the DeBugger game for various users to maximize their learning outcome.

One thing to note is that the DeBugger game is not intended to replace traditional classes, but to be used as an effective support tool like a virtual lab with a TA that provides repetitive practice (lab) and feedback and clarifications from other players (virtual TA), so students can master the core pedagogical components to then progress smoothly.

## DeBugger Implementation

In the DeBugger game, there are many mini games that players can play with other players or against bugs; the DeBugger title was inspired by the origin of the word (removing a bug from computer to fix errors). These mini games (games inside of DeBugger game) are intended for players to develop competence in computer science concepts and fundamental computational approaches when played repeatedly.

*Mini games.* Students who take first Computer Programming courses are introduced to the core concepts of problem solving with pseudo-code, variables, data types and operators, flow controls (selection and iteration), methods, strings, and arrays in sequential order with slight variations. Each mini game has a specific focus so it is designed to work for one concept or one group of a few related concepts. The mini game called “CodeGame” is for learning and practicing program structure, importance of syntax rules, and simple program flow. When the mini game starts, a player will receive a simple mission that is randomly assigned according to the player’s current level with a list of possible answer segments displayed on the left panel as shown in the Figure 2. To solve the mission, the player should pick up correct answer segments and then arrange them on the right answer panel in proper sequence by drag-and-drop. The goal of this mini game is to enable the player to comprehend the functionality of given answer segments and then focus on the program logic. The answer segments can be either actual program code or abstract pseudo code as shown in the Figure 2. Abstract high level code helps students learn problem solving using top-down or divide-conquer approach without thinking of the syntax details. As for the actual program code answers, the mini game presents both correct and incorrect answers in grammar. In this case, to solve the mission, the player must know the precise language syntax and this allows the player to review important language syntax. Screen capture of playing this mini game is recorded and available on YouTube (<http://www.youtube.com/watch?v=wffW7mfd1M4>).

Mission

Possible answer segments



Figure 2. “CodeGame” Interface: a mission is displayed at upper left corner and the answer segments to drag are displayed below the mission. A segment can be dragged and dropped individually.

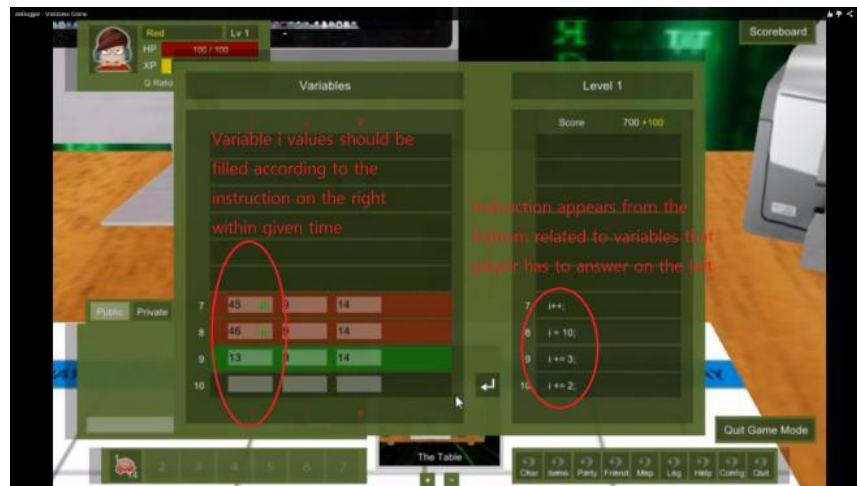

Figure 3. “Variable” game. Player is supposed to fill in the left column where variable slots are, according to instructions that appear one at one time on the right column.

“Variable” game is designed to teach concepts of variables, data types and operations associated with data types. For example, the minigame shows instructions related to a variable ‘i’ type of int, such as  $i++$ , then the player should calculate the value for the variable and enter the value to a variable slot for ‘i’ on the left column within a given time. An instruction can involve more than one variable such as  $j = i/3$ . In this case, the player should read value from i slot and perform integer division. When answer is wrong or the player has reached the time limit, then the row turns to red and stays red, while the right answer turns the line green and clears out. Wrong answers stack up in red rows and the player loses when the stack reaches the top (see Figure 3). Also, the screen capture of this mini game being played is recorded and available on YouTube (<http://www.youtube.com/watch?v=vtcVQG-n8e0>).

The DeBugger features a board game and a fighting game to provide multiple choice questions in more exciting way as shown in the Figure 4. Multiple choice style can cover diverse topics from definition, concepts and picking a correct execution result from a given code segments. These questions are organized into levels in the order of variables, data types and operators, selection flow control, repetition flow control, methods, strings, and arrays. So students can play the most suitable level of topics that they have learned. While answering the multiple choice questions, the player engages in a battle with bugs, a board game with other players, a quest for finding big boss bug with other players, or a PvP (Player vs. Player) game with multiple choice questions. Rewards for playing these games are increasing health, getting game gold, increasing level or getting a gift of game items. Game items can be also purchased with game gold and they are designed to add fun to the game and allow players to have desirable options such as greying out two options from the multiple choices, protecting the player’s health while being attacked by bugs or upgrading decorative items. See the Figure 5.



Figure 4. A player is fighting with a bug (left). Bug asks a question and the player has to answer (right). Health gets damaged as time lapses. Player's health, level, gold are shown at upper left corner. Lower left corner panel serves as a message panel and chat panel.

Based on the designed game architecture, many more mini games can be added easily to allow players to be exposed to further concepts continuously with fun. In addition to the games explained in this paper, there are several more mini games currently available at the DeBugger game<sup>19</sup>.



Figure 5. Player can check their inventory for game items. Players can purchase game items using game gold, trade with other players or give a gift to friends.

*Mobile version.* Players can seamlessly continue to play the game using their mobile devices. Mobile DeBugger game allows for mini games play and maintain the player's inventory, score and all other belongings since they share the same account as the game server and DB server. Currently players can solve multiple choice questions that enable collection of stones for correct answers, so players can directly fight with bugs with stones as weapon. Mobile DeBugger makes use of touch pad for throwing stones in natural pattern, GPS information for finding friends nearby, and accelerometer for shaking off bugs or wrong options during gameplay (Figure 6).



Figure 6. Screen capture of Mobile Debugger. Players can throw stones to the bugs using the touch pad screen.

*Social activity.* There are many social activity features within the DeBugger game. Players can play against each other (See Figure 7.) Also they can chat with other players in a few different ways (public chat, private chat, etc). A player can manage a friends list. Player can choose to show their level and other performance to their friends or the public.



Figure 7. Two players are playing a board game. Each player takes turn, roll the dice, and solve a problem to progress. Winner who arrives the end point faster receives game gold as reward.



Figure 8. Player's performance is measured in diverse ways. And players can see other players' performance unless blocked by the player.

Player's achievement can be measured by levels, number of questions played and the accuracy ratio. Achievement board displays the top 10 high score achievers to encourage players to play longer and better as shown in the Figure 8. Currently, we display players' game IDs with scores but we consider other ways to display scores to encourage players in different levels or promote competitions. For example, in order to promote friendly competition among classes/sections or schools, we consider to display players' section or school information on the board.

Social gaming and MMORPG are relatively recent game genres as they gain popularity over the availability of Internet. Social interaction within the game generates excitement of the game which allows popular games to easily develop communities of multimillion players. Once a community of learners is created, students can learn not only from the educational game components but also from their peers through discussion of problems with them. The DeBugger game was created with the vision of nurturing such a community of learners playing collection of games together, helping each other and inviting more friends to join.

deBugger - User Data							
Variables	Rank	Name	Student ID	Level	Hours	Last Activity	Online
Coding		Abalos, David [ Antorok ]	912387013	3	0.8	04-10-2013	No
Game No.	Level No.	Question ID	Check Type	Success	Seconds		
75	1	1	Regular	Yes	179		
76	2	2	Regular	No	209		
76	2	2	Compile	No	162		
76	2	2	Compile	Yes	169		
77	3	3	Compile	Yes	228		
78	4	4	Compile	Yes	229		
Variables		Alhour, Fadi [ fadi ]	912046764	3	0.81	03-05-2013	No
Game No.	Level No.	Last Step No.	Question ID	Success	Seconds		
83	1	9	1	No	354		
84	1	20	1	Yes	382		
86	2	20	7	Yes	414		
Variables	21	Ang, Victoria [ AngVictoria ]	910058492	4	20.08	03-04-2013	No
No Record							
Variables	21	Bacon, Alexander [ alex.bacon@gmail.com ]	910005595	2	0.48	02-23-2013	No
No Record							
Variables	22	batsaikhan, tsendsuren [ Tsendsuren ]	911702017	4	34.94	02-24-2013	No
Game No.	Level No.	Last Step No.	Question ID	Success	Seconds		

Figure 9. A screen shot of the web site where teachers can see all sorts of students' performance in the DeBugger.

*Player data.* The DeBugger is not only for students. The data collection tool assesses students' learning outcomes automatically and provides useful information (e.g. grading of homework) back to teacher (See Figure 9.) This is very useful and efficient in that teachers save time for grading and students receive feedback immediately. Teachers can see all of the student's performance in diverse analytical views (number of hours, levels, correction ratio, etc).

*Game architecture.* Since the DeBugger game is an online game, we have a game server that runs all the time and supports the virtual DeBugger world persistently. The game server is connected by all the game clients to play the game and updates the database Server. A game client establishes a connection to the game server when a player wants to play the game, receive the latest status of the virtual world that has changed since the last time player logged out, and allows the player to interact with other players who are online. The database server keeps all the data of individual players (health, level, money, game items, friend's list, performance, and etc) and other data to maintain the game world persistent. An efficient game protocol between the server and clients is developed to make the communication effective. The DeBugger game also has a bug server that maintains all the bug characters – how often they appear (spawn), what kind of game item they drop, how aggressively attack players, etc. The bug server also controls bugs' behaviors, such as wandering and reacting to collisions, with simple AI (Artificial Intelligence) to improve the player's fun experience with the game.

Figure 10 shows an architect of the DeBugger game, depicting each component and their connections to each other. The game server was developed using JAVA and MySQL as DB server. Bug server was extended from game client that already included collision handling. The game client was developed utilizing Panda3D, an open source game engine, and python scripts.

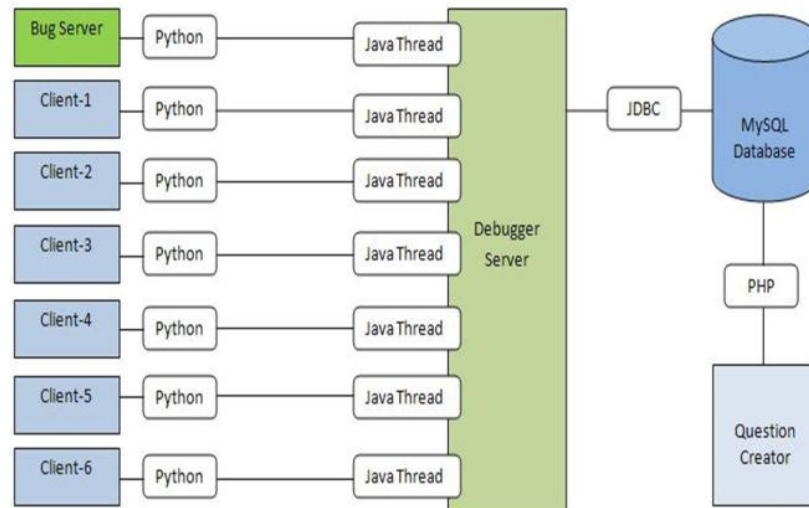

Figure 10. DeBugger Architect. It shows the relationship between a client and the server

Stable support of the DeBugger game server is critically important for MMORPG game. And we evaluated the scalability utilizing Clouds Computing acting as individual clients and DeBugger server stably support 100 concurrent players more than 100 heartbeat per second performance.

### Project Efficacy Testing and Results

*Testing setup.* The DeBugger game has been used at SFSU CSc 210 Introduction to Programming using JAVA during the Spring 2012 (pilot test) & Spring 2013 (official efficacy testing) semesters. During the Spring 2013, 29 student participants were recruited from 4 introductory Computer Science programming classes. Seventeen students were introduced to the DeBugger for the first 2 months as a part of their learning (Experimental Group) while 12 students were not given such exposure to the DeBugger (Control Group). All students were required to study textbook chapters. The experimental group students were asked to use the DeBugger game and collect 60 correct

answers while the control group students were asked to submit a summary of each chapter in a 3 page essay format. We estimated that it would take at the minimum 1 hour a week to complete any one of tasks.

All students were given a pre-test that examined their general knowledge about JAVA programming (e.g., Data types, Variables, Syntax flow) in order to set the baseline performance scores. Mixture of forced choice (i.e., true/false and multiple choice) and open-ended problem solving questions were included. Once pre-test was completed, students in the Experimental Group were given access to the DeBugger for the next 8 weeks. To examine the effectiveness of playing the DeBugger while taking CSc 210, all students were also given a post-test at the end of



the study. The questions on the post-test were identical to the pre-test and students' improved scores from pre- and post-test across two groups were compared.

*Results.* Our preliminary data analyses have shown positive impact of playing the Debugger on student learning outcomes. Figure 11 illustrates participants' mean percent correct on the pre- and post- tests.

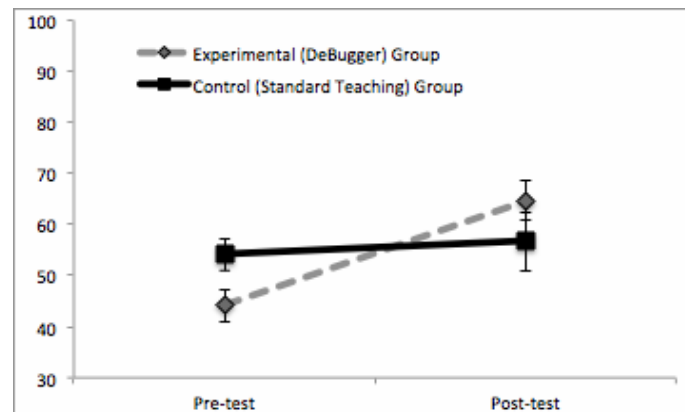

Figure 11. Students' mean percentage scores on pre- and post-tests.

To analyze evaluation results, ANOVA (ANalysis Of VAriance) statistical hypothesis testing was used. All symbols such as  $F$  (F-test statistic ratio),  $p$ ,  $\eta^2$ ,  $M$ (mean),  $SD$ (standard deviation), and  $t$  are standard statistical symbols used in ANOVA. It was found that overall, students' general knowledge about JAVA programming improved significantly from pre-test to post-test,  $F(1,27) = 7.49$ ,  $p = 0.01$ ,  $\eta^2=0.22$ . However, such significant improvement was driven mostly by the Experimental Group as alluded by the significant interaction between the group and testing phase,  $F(1,27) = 4.6$ ,  $p = 0.04$ ,  $\eta^2=0.15$ . Indeed, follow-up post-hoc analysis confirmed that students' performance improved significantly from pre- to post-test only in the Experimental Group where the Debugger was integrated into their learning experience (pre-test:  $M = 44.12$ ;  $SD = 13.25$ ; post-test:  $M = 64.71$ ;  $SD = 16.25$ ),  $t(16) = 4.42$ ,  $p < 0.001$ . For the Control Group, there was no significant improvement in students' scores from pre- to post-test (pre-test:  $M = 54.17$ ;  $SD = 11.65$ ; post-test:  $M = 56.68$ ;  $SD = 20.6$ ),  $t(11) = 0.33$ .

Usability and learning impact of the Debugger is continuously being evaluated. Currently, the Debugger game is being tested at SFSU CSc 210 Introduction to Programming using JAVA during this Spring 2014. There are total of 100 student participants from 2 sections (58 + 42). 88 students participate in using the Debugger (Experimental Group) while 12 students don't (Control Group). Since it is still in the middle of the semester, full analysis data is not available yet. However, we have noticed one significant data showing that an average number of problems students in the experimental group solved using the Debugger is far above the required number 60. Out of 88 participants, 87.5% students collected 110% or more correct answers. Only 11 students collected 110% or less correct answers. The average of 88 students collected 295% correct answers. In order words, so far 120 correct answers were required for students to collect for chapter 1 and 2, but each student voluntarily collected about 360 correct answers on average.

This demonstrates that the DeBugger as a MMORPG can help increase students' study hours painlessly and eventually improve their learning outcome.

Besides getting positive data analysis results, we received many reassuring comments from participants. Following comments from students in the Experimental Group provide noteworthy social cooperative and interactive nature of the DeBugger experience that seems highly conducive for acquiring knowledge while enjoying the process of learning:

*“We played the board game for pretty much the whole hour. It was fun. I explained as much as I could to John, and we had a great time. Debugger is a great place to talk about coding and Java and just hang out.”*

*“There were two other players from CSc 210 that played Debugger today. We played the bugs and board game for about 30 - 40 minutes. It was really fun, and we talked a lot about programming and school and stuff. When we both played the board game at level three, and it's more fun at a harder level because both players can talk about the problem and help each other out with the solution.”*

*“I was able to explain to the other player about short circuiting, compile/run time errors, and other stuff. It was time well spent. I really enjoyed playing Debugger today.”*

Based on the present research findings, we advocate for educational studies that thoroughly investigates the learning impact of individual mini games for pedagogical practices and consequential student learning experience (e.g., peer interactions in virtual community).

### **Ongoing Development**

Further developments are in progress. First addition is for practicing selections (if-else and switch branches) and flow control concepts (e.g. loops). Currently, we are developing a game called “*DeBugger - Infinite Loop*”, an expansion to the DeBugger. The story of Infinite Loop takes place inside a computer that can be reached from the main DeBugger hub area, the Table. Infinite Loop will have its own Hub, the motherboard, where on the first arrival, the player is told about the crisis, that the computer has gone into an infinite loop due to a bug, and is asked for help. The gameplay of Infinite Loop will mainly be delivered by an improved version of the existing battle system currently in place, as well as by a set of mini-games demonstrating the objective programming concepts. Figure 12 and 13 show new features of Infinite Loop.

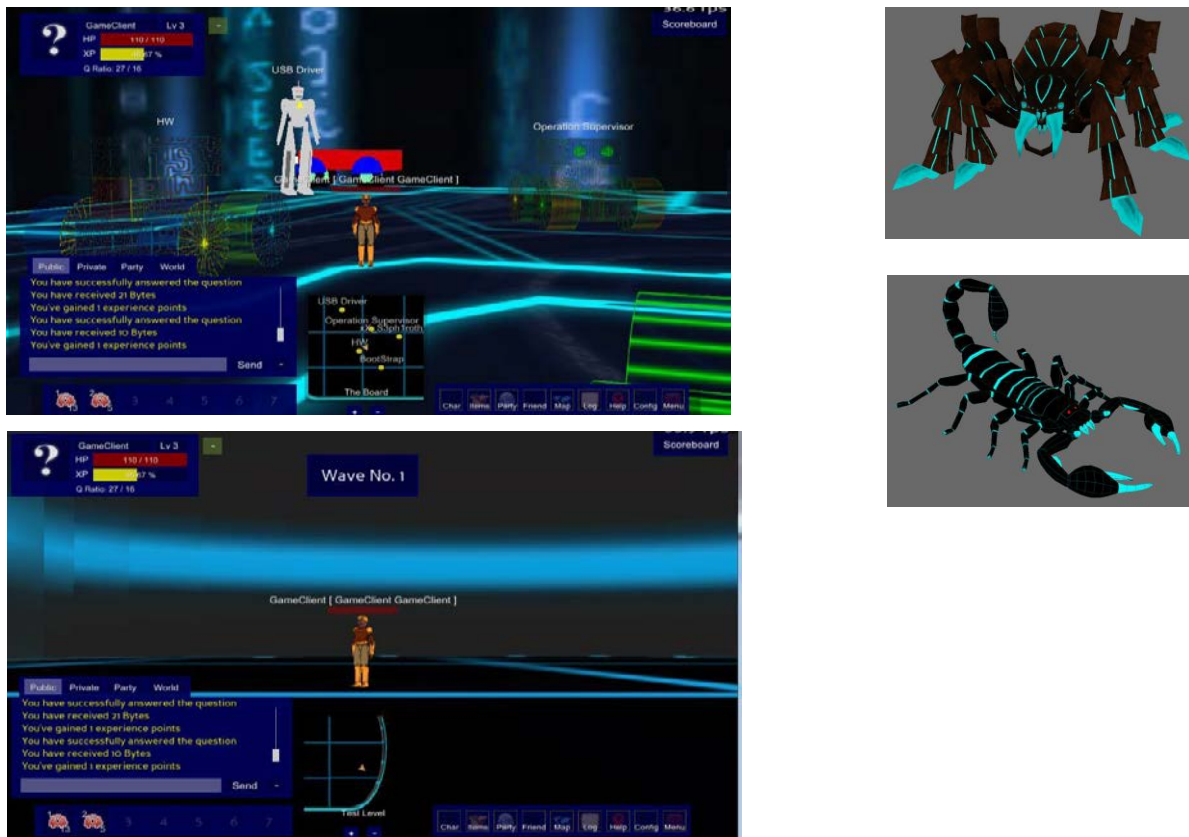

Figure 12. DeDebugger - Infinite loop. Hub area (top-left). New coliseum battle system (bottom-left). Two bug models in the Tron theme (right).

The story of Infinite Loop is composed of 3 main sections, taking place in 3 different areas, a training facility/coliseum mainly focusing on if/else/switch/case, a light-train on the way to the bug mainly focusing on loops, and a final area where the player party will have to face the bug causing the infinite loop. The player will begin in the original game's hub area and talk to an NPC to move to the new hub area -- the motherboard. From the motherboard, they will go to the USB driver to enter into the coliseum. They will do a mixture of coliseum battles and the if-else maze mini-games, eventually moving onto the light train area. From there, they will complete the fight quests and light train mini-games. Then they will move to the final dungeon. They will complete the dungeon and then finish the game.

Infinite Loop is designed to add to the existing DeDebugger not only minigames but also new game features such as generating new question types for if-else and loops, character customization, and GUI manager. As for minigames, coliseum battle system, If-Else maze, and Switch minigames are near completion. In the If-Else minigame, the player starts at a random intersection in the maze. The correct path is randomly generated and answering a question moves the player up, down, left, or right. The goal is to answer 5-10 if-else questions in a row correctly to find the exit. In the Switch minigame, a switch statement question is presented. In it, there are case statements that modify a value 'i'. The goal is to guide a bucket through the rails so that 'i' would be equal to a value that causes the Boolean statement to be true. The player should do this for 5 questions to exit. Answering one question correctly allows the

player to continue to the next question. Figure 13 shows screen shots of two minigames. With additional features, the DeBugger will help students more and better to understand a wide range of JAVA language concepts.

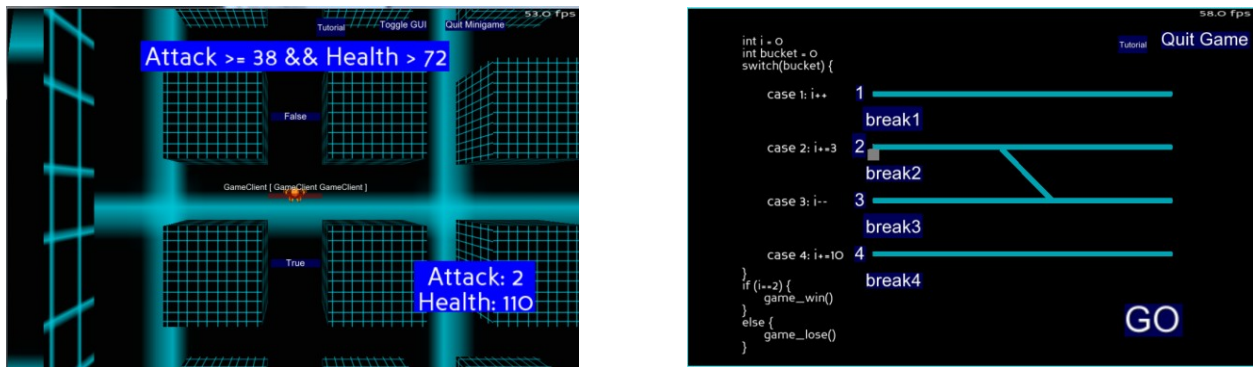

Figure 13. DeBugger – Infinite loop. Top-top view of If-Else Maze game (left). Switch minigame (right).

## Conclusion

We introduced a MMORPG game, DeBugger, which can be used as a primary assistance tool to improve students' learning outcome for Introductory Computer Science course through inherent properties of the MMORPG: addictive and fun game play for repetitive activities and social interaction which results in longer retention and active peer interaction/tutoring. The evaluation results have shown that the impact of the game is effective and socially cooperative as a virtual lab and space for peer instruction.

## Acknowledgment

This project is being partially funded by National Science Foundation NSF DBI- 0543614 and NSF TUES 1140939. CSc 631/831 Multiplayer Game Design and Development course students at fall 2009 contributed to majority of game concept, art work, DB, game contents, client and server implementation.

## Bibliography

1. T. Jenkins. On the Difficulty of Learning to Program. In Proceedings for the 3rd Annual conference of the LTSN Centre for Information and Computer Sciences , Loughborough, UK August 27 - 29, 2002.
2. S. Bergin and R. Reilly. The influence of motivation and comfort-level on learning to program. In Proceedings of the 17th Annual Workshop of the Psychology of Programming Interest Group pages 293-304, University of Sussex, Brighton UK 2005.
3. Jens Bennedsen and Michael E. Caspersen, Failure rates in introductory programming, SIGCSE 2007, pp 32-36.
4. Computing Education for 21st Century (CE21) Program Solicitation NSF 12-527 <http://www.nsf.gov/pubs/2012/nsf12527/nsf12527.htm>
5. V. Barr and C. Stephenson, Bringing computational thinking to K-12: what is Involved and what is the role of the computer science education community?, ACM Inroads, Vol. 2 No. 1, March 2011.
6. Irene, et al., Computational Thinking for Youth in Practice, ACM Inroads, Vol. 2, No. 1, March 2011.
7. Papstergiou, M., Digital Game-Based Learning in High School Computer Science Education: Impact on Educational Effectiveness and Student Motivation, Computers & Education, v52 n1 p1-12 Jan 2009.
8. Ng, Brian D. and Peter Wiemer-Hastings, Addiction to the Internet and Online Gaming, Cyber Psychology & Behavior 8.2 (2005).
9. Seungkeun Song, Joohyeon Lee (2007), Key factors of heuristic evaluation for game design: Towards massively multi-player online role-playing game, International Journal of Human-Computer Studies, no. 65, 709-723.
10. Yee, N. (2002) Understanding MMORPG Addiction.

11. C. Greenwood, J. Delquadri, and R. V. Hall, Longitudinal effects of classwide peer tutoring, *Journal of Educational Psychology*, Vol 81(3), Sep 1989, 371-383.
12. A. King, A. Staffieri, and A. Adalgais, Mutual peer tutoring: Effects of structuring tutorial interaction to scaffold peer learning, *Journal of Educational Psychology*, Vol 90(1), Mar 1998.
13. A. Kolb, The evolution of a conversational learning space, In A. C. Baker, et al. (Eds.) *Conversational learning: An experimental approach to knowledge creation*. Westport, CT: Quorum Books, 2002.
14. S. H. Hsu, , M. H. Wen, and M. Wu, Exploring user experiences as predictors of MMORPG addiction, *Elsevier, Computers & Education*, Vol. 53, No. 3, pp. 990–999, November 2009.
15. Christudason, A. Successful Peer Learning, <http://www.cdtl.nus.edu.sg/success/sl37.htm>
16. Falchikov, N., Blythman, M., *Learning together: peer tutoring in higher education*.
17. Johnson, D.W.; Johnson, R.T.; & Holubec, E.J. (1993). *Circles of Learning*. Edina, MI: Interaction Book Company.
18. Kaufman, D.B.; Felder, R.M.; & Fuller, H. 'Peer Ratings in Cooperative Learning Teams'. *Proceedings of the 1999 Annual ASEE Meeting, ASEE, Session 1430*'.
19. Athalye, A., "Extending the DeBugger Game by Adding 3D Models and Testing Server Scalability" SFSU CS Master Project, 2011, <http://cs.sfsu.edu/techreports/11/CE-11.07.htm>

## LEGO Mindstorms: EV3 versus NXT 2.0 A Laboratory Study in an Introduction to Engineering Course

Ding Yuan, Nebojsa Jaksic, and Jude DePalma  
Colorado State University, Pueblo

### Abstract

The LEGO Mindstorms NXT programmable robotics kit has been a successful tool for enriching K-12 math and science education and for improving recruitment and retention in college-level engineering programs since it was released in late July 2006. Many educational research papers have shown positive results from integrating the LEGO Mindstorms NXT robotics kits into appropriate engineering courses. At our university, the LEGO Mindstorms NXT robotics kits were first introduced to the Introduction to Robotics course in 2006 and since then have played a key role in the first-year Introduction to Engineering course through a robotics mini-lab. They also helped to engage local K-12 students through various outreach programs. In addition, the Mindstorms NXT kits were used in some higher level undergraduate engineering courses like Industrial Robotics and Senior Design Projects. There, students used LabVIEW to program the robots. Complex tasks, however, were not achievable due to the NXTs' memory size limitations. Also, since last year, more frequent hardware failures have occurred in these robotic kits and some of the programmable bricks need to be replaced. The September 2013 release of the new LEGO Mindstorms EV3 robotics kits overcame these issues. It includes a new programmable brick with improved technology (e.g., a faster processor, more memory, a new programming environment, etc.). Consequently, the new LEGO Mindstorms EV3 became a possible choice for upgrading the current lab to a new platform. According to ABET Criterion 3, Student Outcomes k, engineering graduates should be able to "use the techniques, skills, and modern engineering tools necessary for engineering practice." We therefore decided to evaluate students' acceptance of this new, latest technology, engineering tool. In the Fall 2013 semester, three new LEGO Mindstorms EV3s were used in the Introduction to Engineering course. The same mini-lab tasks on robotics were given to students, some using the NXTs and others using the EV3s. An end-of-lab survey was developed, administered, and assessed. The survey results were quite positive and the students preferred to have the more powerful EV3s in the lab.

### Introduction

It has been found that hands-on robotics-based projects can increase students' motivation to learn<sup>1-3</sup>. During the last decade, robotics played an important role in education as an interdisciplinary, project-based learning framework to promote related Science, Technology, Engineering and Math (STEM) fields and benefited education in all levels. Among successful cases reported in various educational research papers, LEGO Mindstorms NXT robotics kit is one of the most popular choices for educators<sup>4</sup>. It has been integrated into different college-level engineering programs<sup>5-9</sup>, from first-year introductory courses<sup>5-6</sup> to upper-division advanced projects<sup>7-8</sup>. It can be an engaging hook to improve retention rate during the first year of college. It also provides a framework to teach basic mechanics, programming, and engineering design concepts since it combines sensors, motors and a programmable brick with a graphic-based programming environment. Moreover, LEGO Mindstorms NXT kits served as a recruiting tool for more and

more universities to attract students into STEM fields and to build connections with potential student in their local community<sup>10-12</sup>. Besides, it has been readily accepted by K-12 teachers to bring STEM concepts into classrooms so as to enrich math and science education<sup>13-14</sup>.

### **Success and Issues with LEGO Mindstorms NXT kits**

At our university, the LEGO Mindstorms NXT robotics kits were first introduced to the Introduction to Robotics course in 2006. Since then more kits were obtained through various resources and they have been used for different purposes. For example, they played a key role in one of the mini-labs designed for the first-year Introduction to Engineering course<sup>5</sup>. They also helped to engage local K-12 students through various outreach programs. In addition, the students in some upper-division undergraduate engineering courses (e.g. Industrial Robotics and Senior Design Projects) programmed the LEGO robots in the NI LabVIEW graphic programming language to fulfill more challenging tasks. However, complex tasks sometimes were not achievable<sup>7</sup> due to the limited memory size in the LEGO Mindstorms NXT brick which only has 256 KB FLASH – RAM and 64KB RAM. Also, since last year, more frequent hardware failures have occurred in these robotic kits and about 10 out of 50 programmable bricks had to be replaced.

In September 2013, the new LEGO Mindstorms EV3 robotics kits were released. Compared to the NXT version, the new EV3 brick has a 300MHz ARM9-based processor with 16MB FLASH and 64MB RAM memory and a new programming environment<sup>15-17</sup>. Moreover, it offers a micro SD card slot which can add up to 32GB extra storage space. A USB host port and a Linux operating system bring allow greater flexibility in expanding the robot's capabilities. For example, a wireless connection can be achieved through a Wi-Fi dongle instead of a Bluetooth connection. Consequently, the new LEGO Mindstorms EV3 became a possible choice for upgrading the current lab to a new platform. Currently, most of the online evaluations on the new EV3s come from either technical reviewers<sup>18-22</sup> or customers (e.g. parents<sup>23</sup>). How college students perceive this new device is still unknown. According to the well-known ABET Criterion 3, Student Outcomes k, engineering graduates should be able to “use the techniques, skills, and modern engineering tools necessary for engineering practice.”<sup>24</sup> Therefore, it is appropriate to evaluate students' acceptance of this new kit with embedded modern technology. In the Fall 2013 semester, four new LEGO Mindstorms EV3s were purchased and later used in one of the mini-labs designed for the Introduction to Engineering course due to its no-prerequisite feature. Purchasing more EV3s was desired for obtaining more students' feedback, but was not an option due to the limited availability of these newly-released kits at that time.

### **Robotics Mini-Lab with EV3s**

At our university, all first-year students who are interested in engineering are encouraged to take a broad-based preliminary course *Introduction to Engineering* at our department. One of the primary goals of the course is to provide the students with a first laboratory experience in engineering fields. An aim of the course is to inspire student interests in engineering, build-up learning community, and thereby improve student retention and success in engineering programs<sup>5</sup>. Accordingly, several mini-labs were designed. The robotics lab was one of them. Given that all freshmen at our university are allowed to take the course, every effort has been made to make the robotics mini-lab fun for both engineering and non-engineering major students, while maintaining the necessary rigor by teaming engineering and non-engineering students together. During the mini lab, each group of students (2-3 per group) builds and

programs a LEGO Mindstorms NXT Robot to accomplish certain tasks by using the Mindstorms NXT graphical programming language. The tasks are designed to be simple enough for students to complete in three class sessions. In the Fall 2013 and Spring 2014 semesters, three out of four EV3 sets were given to the students while the rest of the class still used the NXTs. The same mini-lab tasks on robotics were then given to students, which are shown in Table 1. The grading policy also remained the same as before, whether the group used the EV3 or the NXT.

Table 1. Tasks assigned in mini-lab.

Task No.	Requirement
I - Required	The robot is to operate as follows: 1. After placing robot at the START position the robot should be turned on. 2. Then, robot should travel forward two feet (2"). 3. After that, robot should beep. 4. Then, robot should travel back and return to its starting position. 5. When done, robot should play a tune (your choice) indicating the program is finished.
II - Required	Change the program from Task I so the robot travels in a square 2x2 feet within two minutes.
III – Required	Change the program from Task I so the robot operates as follows: 1. After traveling forward two feet, robot should stop and check if there is an obstacle on its path within 120cm; 2. If robot detects an obstacle on its path within 120cm, it should beep, travel backwards and return to its starting position; 3. If robot doesn't detect an obstacle on its path within 120cm, the robot should beep differently, continue moving two feet, and then stop.
IV – Optional	Develop a program for the robot so that the robot can keep tracking one person's movement on a straight path, and keep its distance to this person within 40 to 60cm.

With the short timeline of the mini-lab, the team typically used one class session to build a robot, one to learn programming and test the robot, and the last one to accomplish the given tasks and demonstrate to the instructors (as shown in Figure 1). Three robots built with the LEGO Mindstorms EV3 robotics kits by the students in the Spring 2014 semester are shown in Figure 2.



Figure 1. Students in robotics mini-lab.



Figure 2. EV3 robots built in Spring 2014.



## Results

An end-of-lab anonymous survey was developed and administered to evaluate students' satisfaction on these new EV3s. To compare the two kits, the new EV3s were preferably given to the students having previous experience with LEGO robots. In the Fall 2013 semester, eight out of 21 students self-identified as "experienced" LEGO players while in the Spring 2014 semester, only three of 21 students claimed previous LEGO experience. In order to fully use all three kits, eight "experienced" students in Fall 2013 were formed into three groups while three "experienced" students in Spring 2014 became the leaders of three different groups. However, only the "experienced" students were asked to complete the EV3 related survey at the end of the lab.

In the survey, the students were asked to rank their perception on six questions with 1 being the lowest and 5 being the highest rating. The survey questions and the corresponding average scores for each question are included in Table 2. As mentioned before, a total of eight students completed the survey in the Fall 2013 semester and only three students did the same survey in the Spring 2014 semester. The average scores of the total 11 responses in both semesters are represented in the last column of Table 2. Since a score of 5 is described as the most favorable score in the survey, the average rating above 4.0 in most data calculated in the last column indicates a positive feedback from the students when comparing the EV3s to the NXTs. The only exception (i.e. the average score is less than 4.0) in the last column is related to Question 3. An overall average of 3.36 in response to the intuitiveness of the EV3 graphical user interface when comparing to the Mindstorms NXT indicates that the students only recognized a slight improvement in the EV3 version. Such a conclusion can be consistently drawn from the data in both the fall and the spring semesters. This may be because the lab timeline is so tight that some students may not even notice some improvements on the EV3 graphical user interface, e.g. the built-in documentation tool. Besides, the given tasks were quite simple and didn't require a lot of programming skills. In general, the students were still satisfied with the software aspect of the EV3s since the rating of Question 4 still showed a preference towards the EV3 software environment.

Table 2. Survey results (1 being the lowest and 5 being the highest rating)

Survey Questions	Average in Fall 2013	Average in Spring 2014	Average of total 11 responses
1. How exciting are EV3s when compared to Mindstorms NXTs?	4.00	4.33	4.09
2. How easy is it to build robots using EV3s when compared to Mindstorms NXTs?	4.13	3.67	4.00
3. How intuitive is the EV3 graphical user interface when compared to Mindstorms NXT?	3.38	3.33	3.36
4. In general, are EV3s easier to program than Mindstorms NXTs?	4.50	4.33	4.45
5. How cool are EV3s when compared to Mindstorms NXTs?	4.50	4.67	4.55
6. Would you recommend the use of EV3s in EN101 next year?	4.75	5.00	4.82

Another average rating that is lower than 4.0 in Table 2 is related to the responses of Question 2. This is reasonable since the physical building techniques remain the same between NXTs and EV3s. However, it is noticeable that the results in the fall and the spring semester are not very consistent. This may be due to the different ways the teams were formed. In the fall semester, everybody in an EV3 team had some experience with LEGO robots while in the spring semester, the one who completed the survey was the only one in his/her group that had some previous experience. Therefore, they had to lead the whole team to build a robot together which required more responsibility on teaching others in the group.

Considering the purpose of evaluating the new EV3s in the mini-lab, the last question is designed to determine the students' perceived value of the new EV3 units. The highest average score among all survey questions showed a welcome from the first-year students to this new platform. Since the EV3 brick with new powerful hardware features can be used with more advanced engineering projects and its software is backwards compatible with the NXT, it may be a better approach to start upgrading the LEGO mini-lab with the new EV3 sets, instead of just replacing the malfunctioned NXT programmable bricks. However, one concern arose unexpectedly. In October 2013, a total of four sets of brand new EV3 robotics kits were purchased. Initially, it was planned that three of them be used in the mini-lab and one to be reserved for the instructors to develop additional labs for higher level engineering classes. However, one EV3 brick malfunctioned in late November. Consequently, the reserved set had to be used for the Spring 2014 semester. It was later found that the brick needed a firmware upgrade only, which alleviated the concern. Necessary third-party support for the EV3 is still under way. For example, the current LabVIEW for LEGO Mindstorms module doesn't support the new EV3 bricks. According to one of the product support engineers at the NI LabVIEW R&D section<sup>23</sup>, the new module is planned to be released in the first half of this year. Therefore, more advanced LabVIEW-based projects will have to wait until the supporting function blocks become available.

## Conclusions

The new LEGO Mindstorms EV3 robotics kits were used in an introductory engineering course to evaluate the students' acceptance of this modern tool. An anonymous end-of-lab survey was developed and administrated. The survey results were favorable and the students appeared to be ready to embrace the new powerful EV3s. The improved features in both hardware and software with EV3 make upgrading the related lab a more promising idea. More advanced labs will be possible thanks to the improved hardware features, but the required third-party support is still under development.

## Bibliography

1. Pomalaza-Raez, C., and Groff, B. H., "Retention 101: Where Robot Go ... Students Follow," *Journal of Engineering Education*, vol. 92, No. 1, January 2003, pp. 85-90.
2. Meyers, K. and Mertz, B., "A Large Scale Analysis of First-Year Engineering Students Essays of Engineering Interests," *Proceedings of the 2011 ASEE Annual Conference & Exposition*, AC 2011-727, Vancouver, BC, Canada, June 26-29, 2011.
3. Mertz, B. and Atwood, S. A. , "Analysis of First-Year Engineering Student Essays on Engineering Interests for Institutions of Different Carnegie Classifications," *Proceedings of the 2012 ASEE Annual Conference and Exposition*, AC 2012 – 4380, San Antonio, TX, June 10-13, 2012.
4. Lau, P., McNamara, S., Rogers, C., and Portsmore, M., "LEGO Robotics in Engineering," *Proceedings of the 2001*

- ASEE Conference and Exhibition*, Albuquerque, NM, June 24-27, 2001.
5. Yuan, D., DePalma, J. I., Jaksic, N. I. and Fraser, J. M., "A Learning Community for First-Year Engineering Courses," *Proceedings of the 2011 Annual Conference and Exposition*, AC 2011 – 1890, Vancouver, BC, Canada, June 26-29, 2011.
  6. Jefferson, G. D., Steadman, S., Thomas, T. G. and Hsiao, K-T, "Novel First Year Engineering Summer Session," *Proceedings of the 2013 ASEE Southeast Section Conference*, Cookeville, TN, Mar. 10-12, 2013.
  7. Jaksic, N. and Spencer, D., "A Multidisciplinary Laboratory Course: Robotic Design and Programming with Mindstorms," *Proceedings of the 2008 ASEE Annual Conference and Exposition*, AC2008-2567, Pittsburgh, PA, June 22-25, 2008.
  8. Jones, J. P., McArthur, C. W., and Young, T. A., "The VU-LEGO Real Time Target: Taking Student Designs to Implementation," *Proceedings of the 2011 ASEE Annual Conference and Exposition*, AC 2011 – 2476, Vancouver, BC, Canada, June 26-29, 2011.
  9. Tremberger, G. Jr., et al., "Applications of Arduino Microcontroller in Student Projects in a Community College," *Proceedings of the 2012 ASEE Annual Conference and Exposition*, AC 2012 – 3977, San Antonio, TX, June 10-13, 2012.
  10. Goeser, P. T., Coates, C. W., Johnson, W. M., and McCarthy C., "Pushing the Limit Further: Exposure of High School Senior to Engineering Research, Design and Communication," *Proceedings of the 2009 ASEE Southeast Section Conference*, Marietta, GA, Apr. 5-7, 2009.
  11. Takaghaj, S. M., Macnab, C. and Friesen, S., "Inspiring Girls to Pursue Careers in STEM with a Mentor- Supported Robotics Project," *Proceedings of the 2011 ASEE Annual Conference and Exposition*, AC 2011 - 1100, Vancouver, BC, Canada, June 26-29, 2011.
  12. Salzman, N. and Strobel, J., "Motivations and Benefits for College Students Serving as Mentors in a High School Robotics Competition," *Proceedings of the 2011 ASEE Annual Conference and Exposition*, AC 2011-2846, Vancouver, BC, Canada, June 26-29, 2011.
  13. Jawaharlal, M., Larriva, C., and Nemiro, J., "School Robotics Initiative – An Outreach Initiative to Prepare Teachers and Inspire Students to Choose a Career in Engineering and Science," *Proceedings of the 2007 ASEE Pacific Southwest Annual Conference*, Reno, NV, Apr. 12-13, 2007.
  14. Usselman, M. *et al.*, "Integrating K-12 Engineering and Science: Balancing Inquiry, Design, Standards and Classroom Realities," *Proceedings of the 2013 ASEE Annual Conference & Exposition*, Paper ID 6591, Atlanta, GA, June 23-26, 2013.
  15. <http://botbench.com/blog/2013/01/08/comparing-the-nxt-and-ev3-bricks/>, retrieved on 01/24/2014.
  16. <http://www.damienkee.com/home/2013/1/9/ev3-vs-nxt-the-educators-dilemma.html>, retrieved on 01/24/2014.
  17. <http://www.pcmag.com/article2/0,2817,2423200,00.asp>, retrieved on 1/24/2014.
  18. <http://www.intorobotics.com/sensors-lego-mindstorms-ev3-features-comparison/>, retrieved on 01/24/2014.
  19. <http://www.damienkee.com/home/2013/6/20/first-look-at-the-new-ev3-software.html>, retrieved on 01/24/2014.
  20. <http://www.legoengineering.com/using-ev3-software-to-run-the-nxt/>, retrieved on 01/24/2014.
  21. <http://arstechnica.com/gadgets/2013/08/review-lego-mindstorms-ev3-means-giant-robots-powerful-computers/>, retrieved on 01/24/2014.
  22. <http://geekmom.com/2013/08/ev3-review-lego-robot/>, retrieved on 1/24/2014.
  23. <http://forums.ni.com/t5/LabVIEW-for-LEGO-MINDSTORMS-and/LabVIEW-for-LEGO-MINDSTORMS-and-EV3/td-p/2529654>, retrieved on 1/24/2014
  24. [http://www.abet.org/uploadedFiles/Accreditation/Accreditation\\_Process/Accreditation\\_Documents/Current/eac-criteria-2012-2013.pdf](http://www.abet.org/uploadedFiles/Accreditation/Accreditation_Process/Accreditation_Documents/Current/eac-criteria-2012-2013.pdf), retrieved on 3/10/2014

## **Initiatives to Improve Student Success and Retention in The Lyles College of Engineering California State University, Fresno**

Manoochehr Zoghi, Hernan Maldonado, and Syreeta Martinez  
California State University, Fresno

### **Abstract**

It is widely known that the science, technology and innovation (STI) are important drivers of the economy, which affect nearly all aspects of our everyday lives. Engineering is in turn central to the innovation and our modern society. Recently, however, there has been a great deal of concern regarding the future of engineering education in the U.S. and abroad. Three key challenges have been at the core of these deliberations involving globalization, public perceptions of engineering, and retention of engineering students. This article will focus on the third challenge and strategies developed in the Lyles College of Engineering at California State University, Fresno ('Fresno State') to improve the student success and in turn the retention. Attrition of engineering students, especially during the early semesters, is staggering. It is estimated that nationally only 50 to 60 percent of engineering students graduate in six years. It has been determined that engineering students often do not identify themselves with engineering during the first two years because they are primarily taking math and science and other general education courses, thus, very little exposure to engineering. Students are dissatisfied with the teaching and advising within the engineering disciplines. Also, the curricula may be too restrictive. Attrition is typically higher among women and minorities.

Fresno State, designated as Hispanic Serving Institution (HSI), faces similar challenges. First time/full time freshmen 4-year graduation rate is 14%, 6-year graduation rate is 49%, respectively. Lyles College of Engineering has launched a number of initiatives in relation to student success to improve retention. These entail summer enrichment workshops, articulations with community colleges, academic success workshops, intrusive academic advising for students that are academically at-risk, peer mentoring programs, professional speaker series, field trips, tutoring services, professional development workshops, and numerous other opportunities that will be elaborated herein.

### **Introduction**

In a recent report, published by the National Science Board, entitled: "Moving Forward to Improve Engineering Education," it is accentuated that rapid changes are taking place for engineering on a global scale, which require Federal leadership to respond quickly and informatively.<sup>1</sup> Following an extensive deliberation via a series of workshops, the Board identified three key challenges in engineering education: (1) responding to the changing global context of engineering, (2) changing the public perceptions of engineering, and (3) retention of engineering students. The third challenge for engineering education, i.e., student success and retention, specifically in the Lyles College of Engineering at California State University, Fresno ('Fresno State'), will constitute the crux of the present paper. Attrition of students entering engineering programs is staggering. According to the aforementioned report, merely 50 to 60 percent of students majoring in engineering graduate in six years<sup>1</sup>. Why do so many students drop

out of engineering or switch their majors? Recent studies point to three main reasons: (1) poor teaching and advising/mentoring, (2) difficult and inflexible curricula, and (3) lack of “belonging” within the first two years.<sup>2,3</sup> The average attrition rate is higher among female and minority students. Regarding teaching and advising/mentoring, there have been myriad of teaching and learning centers instituted on many campuses across the nation in recent years. Not only these centers provide opportunities for the faculty appraising the modern technologies related to teaching and classrooms, they also deliver workshops about students’ different learning styles and better ways of advising/mentoring.

Traditional engineering curricula have been inflexible and frontloaded with non-engineering major courses such as math, science and general education, which are offered by departments outside engineering. In recent years, broad spectrum of instructional approaches have been developed to address some of these issues such as collaborative learning, problem-based learning, writing across curriculum, freshman experience, introduction to design, and so on.<sup>4</sup> Felder, et al.<sup>5</sup> point out that the long-term benefits of these methods, however, have been at best tenuous mainly because they are typically carried out short term. Felder, et al.,<sup>6,7,8,9</sup> conducted further studies in relation to student success and retention including their learning styles, performance and attitude differences between students from rural and urban backgrounds, and between male and female students, etc. Among others, they concluded that there are factors in students’ background that might be significant predictors of their success or failure. It was also found that the experimental instructional approach has positive effects on students’ academic performance, motivation to learn, and attitudes toward their education and themselves. As for the third item listed above; i.e., students’ ability to identify with engineering, Matthews report<sup>2</sup> that for a student to feel he or she belongs to undergraduate peer group is a key ingredient in retention. This is especially palpable among women and students of color, considering that engineering is still primarily a male, white dominated field. Kaufman<sup>10</sup> states: “The data are in: feeling as though you belong in a field, and that the learning environment is accepting, comfortable, and trustworthy, matters quite a lot— not only for people’s motivation to engage in a domain, but also how high they eventually soar.”

We will elaborate on various approaches the Lyles College of Engineering (‘LCOE’) at Fresno State has adopted to address the preceding challenges. The great majority of these efforts are coordinated through LCOE’s Pathways Student Services Division, henceforth referred to “Pathways.” Pathways at Fresno State offers a wide variety of resources and services that are tailored to address the individual needs of all students in LCOE, consistent with the three prong challenges mentioned above. Another entity that is housed within LCOE is the MESA (Mathematics Engineering Science Achievement) Schools Program. The MESA Program has been serving students in the Central San Joaquin Valley since 1980. Originally founded at UC Berkeley in 1970, MESA’s mission is to encourage students, especially those from underserved populations, to learn about math, engineering, and science in new and exciting ways. Furthermore, MESA has a tradition of preparing students to pursue STEM majors in 4-year colleges and universities. Another unique feature of the LCOE is its VIP (Valley Industry Program). VIP was initiated as a partnership between LCOE and a number of local companies. The primary goal of the program is to provide a richer, well-rounded, educational experience for engineering students. This is achieved by providing students experiential learning in a real-world engineering environment. These programs will be further elaborated in the ensuing sections of this article.

### **Advising and Mentoring**

An essential service provided by Pathways: Student Services Program of the Lyles College of Engineering at Fresno State is academic advising. A survey, conducted by LCOE in fall 2013, reported that one of the most useful services provided to them was thorough robust academic advising. The Pathways program provides academic advising to an average of 15 students per week throughout each semester. Over 240 students were provided academic advising services during fall 2013 semester. LCOE advising includes help on academic plan development, course enrollment, unit loads, program requirements, prerequisites, graduation requirement reviews, as well as intrusive academic advising for students that are academically at-risk. Students that seek academic advising through the Pathways program are more likely to make positive progress towards graduation and graduate in a timely manner. The academic advising provided by the Pathways is completely voluntary for the general student population in the Lyles College of Engineering, but mandatory for the at-risk student population.

The Lyles College of Engineering operates with the belief that all students who wish to become engineers deserve the support and the opportunity to be successful. The old premise that still exists in some engineering programs: “look to your right and look to your left, two of you will not finish the program” as an prevailing rite of passage, is unacceptable at the Lyles College of Engineering. The Lyles College of Engineering believes in providing its students with all the services and tools necessary to be successful. Through the Pathways: Student Services Program, the Lyles College of Engineering has developed an intrusive academic advising process for at-risk students. At-risk students in the Lyles College of Engineering are students that have a term grade point average of 2.03 or lower. Students that fall within the at-risk category are required to complete a four-step process that is designed to help them get back in good academic standing. There are four steps that each LCOE at-risk student must follow:

1. Obtain an academic tracking card that requires signatures from the workshop facilitator, pathways director and faculty advisor;
2. Attend an academic success workshop and have the card signed by the workshop facilitator;
3. Meet with and obtain advising from the Pathways: Student Services program as well as obtain a signature from the Pathways program director;
4. Meet with the faculty advisor that reviews recommendations made by the Pathways program director and provide final program recommendations for the student to follow in order to complete the at-risk process so that they are no longer on academic probation.

Every semester, an average of 80 (5%) students (of 1430 total engineering students) fall within the at-risk group. Nearly 70% of students that complete the at-risk student process in the Lyles College of Engineering either get back in good academic standing or do not return to the Lyles College of Engineering the following semester. Through the aforementioned at-risk process, students understand that in the Lyles College of Engineering, they are not just a number and that the College cares about the success of every one of its students.

### **Curricular Innovation**

Established in 1922, LCOE offers nationally accredited B.S. degrees in Civil Engineering, Geomatics Engineering, Electrical Engineering, Computer Engineering, Mechanical Engineering, and Construction Management. All engineering programs are accredited by ABET (Accreditation Board for Engineering and Technology, Inc.), whereas, the construction management program is

accredited by ACCE (American Council for Construction Education). The mission of LCOE is to provide high quality academic programs in engineering and construction management that support the infrastructure and growth of the Central California region. With regional industry partners, these programs are linked through cooperative education opportunities, internships, projects, and course assignments. The college also offers an accelerated master's program that allows qualified undergraduate students to begin graduate studies at the start of the first semester of their senior year. Nearly all LCOE programs are broad-based with substantial hands on experiential opportunities via laboratories, optional internship, project-based learning (PBL), and senior capstone projects, etc. Some of recent reforms urged nationally such as emphasis in teamwork, communication skills, and interdisciplinary design have been integrated throughout the curricula. Furthermore, a close partnership has been developed between LCOE and Lyles Center for Innovation and Entrepreneurship (LCIE) to promote entrepreneurial endeavors within various disciplines. Four full time faculty members in Civil Engineering, Construction Management, Electrical Engineering and Mechanical Engineering, have been awarded the designation of the Coleman Entrepreneurship Fellows. The Coleman Fellows are engaged in developing either new courses in their disciplines related to entrepreneurship and/or revising existing courses to integrate entrepreneurship, as well as leading projects in support of entrepreneurship education within their respective programs.

In addition to incorporating entrepreneurship endeavors, described above, a couple of programs have adopted variations of the CDIO (Conceive-Design- Implement-Operate) initiative to enhance their undergraduate curricula.<sup>11</sup> CDIO initiative, originally developed at MIT in late 1990s, is an innovative educational framework to prepare the next generation of engineers and construction managers. The CDIO framework relies on the following three overall goals in order to educate future engineers who are: (1) grounded in a deeper working knowledge of technical fundamentals; (2) able to lead in the creation and operation of new products, processes, and systems; and (3) have an understanding of the significance and strategic impact of research and technological development on society.<sup>12</sup> It is beyond the scope of this manuscript to present details of curricula innovation for the aforementioned programs in LCOE. Specifics of curricula revisions aligned with CDIO initiative can be found in Sanchez et al.<sup>13</sup> and Zoghi et al.<sup>14</sup>

Another feature of LCOE that has improved the student success is in relation to the supplemental instruction (SI) for several courses. The basis of SI is to supplement existing lecture series by the instructor with additional SI-led sessions, typically by a senior student in an interactive recitation venue. The SI leader works closely with the course instructor and is a facilitator but not an instructor and does not present any new course material.<sup>16</sup> S/he is trained prior to assuming her/his tasks as a SI leader and is supervised throughout the process. Supplemental instruction was launched for the first time for a course in the Lyles College Engineering in fall 2013. In order to determine what engineering courses should be targeted for supplemental instruction, the Academic Committee of the Lyles College of Engineering examined data on the courses with the lowest passing rates. Five courses were identified, but only one SI session was offered for the Digital Logic course in the Electrical and Computer engineering program (ECE 85). The course was chosen because the two sections were being taught by two different faculty members. This would allow the Academic Committee to use the Supplemental Instruction program as a pilot to compare courses with the SI session and without the SI session.

An upper-division student majoring in Electrical Engineering was identified as the Supplemental

Instruction course leader for the Digital Logic course. The student was provided with SI training by meeting with the instructor to review the material that would be covered in the class lectures. The SI leader attends the lectures on a regular basis and works side by side with the instructor to prepare for the Supplemental Instruction Session. The SI leaders are taught how to develop practice worksheets that reinforce concepts covered in lectures. The SI session was offered for fourteen weeks of the sixteen-week semester. The SI Session began a week after the start of the semester to allow students to finalize their schedule before receiving information about the SI Session. SI Session attendance is completely voluntary. Campus wide data at Fresno State reveals that students attending a SI Session five or more times during the semester are much more likely to receive a passing grade in a course.

The results of the Electrical and Computer Engineering ECE 85 course offered during fall 2013 that had a Supplemental Instruction Course compared to another section of the same course that did not have a Supplemental Instruction (Data obtained from [www.myedu.com](http://www.myedu.com)) are presented in Figures 1 and 2. The course description is provided below.



Figure 1. Grade history for ECE 85 with supplemental instruction.



Figure 2. Grade history for ECE 85 without supplemental instruction.

#### ECE 85 Course Description:

Discrete mathematics, logic, and Boolean algebra. Number systems and binary arithmetic, combinatorial logic and minimization techniques. Analysis and design of combinatorial circuits using logic gates, multiplexers, decoders, and PLD's. Flipflops, multivibrators, registers, and counters. Introduction to synchronous sequential circuits and state machines.

The ECE 85 course with the Supplemental Instruction had a total of 44 students enrolled in the course in fall 2013. A total of 22 students attended the Supplemental Instruction sessions three or more times during the fall 2013 semester. As can be observed, the ECE 85 course with the Supplemental Instruction had a lower percentage of grades with an "F" than did the course



without the Supplemental Instruction (19% vs. 38%). Larger number of students in the ECE 85 course with the Supplemental Instruction received grades of C or better (64%) than the students in the ECE 85 course without the Supplemental Instruction (50%). It can also be observed that only 36% of the students in the ECE 85 course with the Supplemental Instruction received unsatisfactory grades of D or F, while 51% of students in the ECE 85 course without the Supplemental Instruction received unsatisfactory grades of D or F. A total of 43 students were enrolled in the ECE 85 course that did not have a Supplemental Instruction Session.

Based on the positive results from the pilot Supplemental Instruction project in fall 2013, the Lyles College of Engineering decided to expand its Supplemental Instruction Program to three courses for the spring 2014 semester. These courses historically have low passing rates, Thermodynamics in the Mechanical Engineering Program (ME 136), Introduction to Structures in Civil Engineering Program (CE 130) and Digital Logic Design in the Electrical and Computer Engineering Program (ECE 85). We anticipate positive outcomes from the pilot program to continue with the three courses being offered in spring 2014 semester.

### **Need for Belonging**

There is a significant body of research painting a consistent and important picture that an individual's sense of belonging matters.<sup>10, 15</sup> *"The need for belonging is a fundamental human motive,"* affirms Kaufman.<sup>10</sup> One of the newest LCOE initiatives is peer-mentoring, facilitated by the Pathways student services division. The intent of the peer-mentoring program is to team new and/or lower class engineering and construction management students with upperclassmen or graduate student peer mentors. The primary goal of LCOE peer-mentoring program is to support the personal and academic development and achievement of new and lower division engineering students, especially female and underrepresented minority students, and to instill in them a sense of belonging. The interaction between a mentor and mentees is mutual. The mentees benefit personally and professionally from the insight and guidance of their more experienced peer mentors. The mentor finds it rewarding being able to make a difference in another student's life and making meaningful contributions to student's development while experiencing continued growth themselves.<sup>17</sup>

The Lyles College of Engineering launched a mentoring program for its first-year students in fall 2013. The program is intended to keep first-year students engaged in the College of Engineering so they feel better connected and included in the engineering student community. As part of the engineering curriculum at Fresno State, students seldom take engineering courses during the first two-years of a student's academic career; the curriculum requires students to focus on prerequisites that involve math, physics and other science courses. Through the mentoring program, first-year students will be paired with the top 20% of junior and senior students in each of the six disciplines in the Lyles College of Engineering. The intent is to have upper-division students help with the transition of first-year students from high school to college, providing them with advice on courses, introducing them to professional engineering student organizations and most importantly to help them develop and strengthen their study skills so that they can be successful in attaining their engineering degrees.

The first-year student will be carefully paired with upper-division students that are within their respective major and that have similar interests, in hobbies and extra-curricular activities. First-year students and upper-division students will complete an extensive personal questionnaire that

will be used to pair the students. Most of the mentoring will be done on a one-on-one basis with few mentors being assigned more than one mentee/protégé. The mentoring time commitment is one calendar year with the intent that the mentor/protégé relationships will continue well beyond the required one year and turn to life-long learning relationships. In fall 2013, approximately 45 first-year students were accepted into the mentoring program and new cohorts will be added as new students enter the Lyles College of Engineering each fall.

The MESA program, supported by the LCOE, also seeks engineering students involved in professional student organizations to volunteer their time to become mentors for Middle and High School students. There are currently 1052 students enrolled in the MESA program at LCOE representing 24 schools from the Central California Region. MESA conducts 4 academies a year in which over 80 engineering students volunteer to facilitate math, engineering and science workshops. A few of the most popular workshops held on the Fresno State campus include Lego Robotics, Balsawood Glider, Egg X-press, Suspension Bridge, Hovercraft and the Prosthetic Arm. The key success to MESA is having engineering students eager to engage with middle and high school students, giving them a deeper understanding of concepts related to the engineering field in a unique and fun environment. The mentor-mentee relationship between our engineering students and middle and high school students is crucial in the learning process of the MESA program.

### Conclusions

The retention and graduation rates of students entering the Lyles College of Engineering are consistent with the national statistical data. Nearly 50 percent graduate within six years. Thus, attrition has been a major challenge. In this paper, a wide variety of approaches, adopted by the LCOE, to address student success and retention have been presented. These include academic coaching, advising, peer mentoring, supplemental instruction, curriculum innovation and so on. It is evident that all these approaches are helpful and improve students' success, engagement and sense of belonging, and retention. It is realized that the success of these programs hinges on their longevity. The Lyles College of Engineering has been able to fund these projects in the past and is looking for other opportunities to make them sustainable long term.

### References

1. National Science Board (NSB), Moving forward to improve engineering education, National Science Foundation Document Number NSB07122, November 19, 2007.
2. Matthews, M., Keeping students in engineering: A research-to-practice brief, American Society of Engineering Education, Editorial: [www.asee.org](http://www.asee.org), February 25, 2012.
3. Marra, R.M., Rodgers, K.A., Shen, D., & Bogue, B. (2012), Leaving engineering: A multi-year single institution study, *Journal of Engineering Education*.
4. Brown, C.M. & Brodersen, A.J. (2004) A comparative study of traditional instruction versus experimental instruction, ASEE Southeast Section Conference.
5. Felder, R.M., et al. (1993), A longitudinal study of engineering student performance and retention: I. Success and failure in the introductory course, *Journal of Engineering Education*, 82(1), 15-21.
6. Felder, R.M., et. al. (1994), A longitudinal study of engineering student performance and retention: II. Differences between students from rural and urban backgrounds, *Journal of Engineering Education*, 83(3), 209-217.
7. Felder, R.M., et. al. (1995), A longitudinal study of engineering student performance and retention: III. Gender differences in students performance and attitudes, *Journal of Engineering Education*, Vol. 84 (2), 151-174.
8. Felder, Richard et. al. (1995), A longitudinal study of engineering student performance and retention: IV. Instructional methods and students responses to them", *Journal of Engineering Education*, 82(1), 15-21.

9. Felder, Richard et. al. (1998), A longitudinal study of engineering student performance and retention: V. Comparisons with traditionally-taught students”, *Journal of Engineering Education*, 87(4), 469-480.
10. Kaufman, S.B., The need for belonging in math and science, *Scientific American*, October 21, 2013, Accessed at: <http://blogs.scientificamerican.com/beautiful-minds/2013/10/21/the-need-for-belonging-in-math-and-science/> on January 20, 2014.
11. CDIO (Conceive-Design-Implement-Operate) Initiative, Accessed at: [www.cdio.org](http://www.cdio.org) on January 20, 2014.
12. Crawley, E., Malmqvist, J., Ostlund, S., Brodeur, D., *Rethinking engineering education: The CDIO Approach*, Springer Science + Business Media, LLC, New York, NY, 2007, p. 286.
13. Sanchez, M., Zoghi, M., Mizuno, W., Mechanical engineering undergraduate curriculum revisions in accordance with the CDIO Initiative, *Proceedings of the 2012 ASEE PSW Section Conference*, Cal Poly San Luis Obispo.
14. Zoghi, M., Crask, L., Hyatt, & B., Luo, Y., Curriculum innovation with leadership opportunities to engage students at all levels, *Proceedings of the 2012 ASEE PSW Section Conference*, Cal Poly San Luis Obispo.
15. Baumeister, R.F. & Leary, M.R. (1995), The need to belong: Desire for interpersonal attachments as a fundamental human motivation, *Psychological Bulletin*, 117(3), 497-529.
16. Malm, J, Bryngfors, L., Mörner, L. (2011), Improving student success in difficult engineering education courses through Supplemental Instruction (SI) – What is the impact of the degree of SI attendance? *Journal of Peer Learning*, 4(1), Article 4, Published by the University of Wollongong, 16-23.
17. CU Empower, Cornell University College of Engineering Peer Mentoring Program, Accessed at: [http://www.engineering.cornell.edu/diversity/events/peer\\_mentor.cfmon](http://www.engineering.cornell.edu/diversity/events/peer_mentor.cfmon) January 20 2014

## Integrating Entrepreneurship Opportunities to Improve Engineering Students Experiential Learning

Shervin Zoghi, Eric Liguori, Manoochehr Zoghi, Fariborz Tehrani, The Nguyen  
California State University, Fresno

### Abstract

Entrepreneurship is associated with a combination of intelligence, creativity, risk-management, dealing with uncertainties, and persistence in achieving one's goals. Many of these traits are also characteristics of engineers, who bring about innovation. Indeed, it has been stated that engineers make great entrepreneurs. Following are few distinguishing attributes: problem solving, optimism, high tolerance for uncertainties, insightful, creative, and forward thinking. Lyles College of Engineering at Fresno State, in partnership with the Lyles Center for Innovation and Entrepreneurship, is in the process of incorporating entrepreneurship concepts longitudinally in the engineering curricula in various forms to enhance student experiential learning. We believe integrating entrepreneurship in engineering education will help students better prepare for productive careers as leaders in their profession.

We have been exploring different ways of integrating entrepreneurship endeavors in the engineering curricula in order to promote student engagement and well roundedness. Through workshops and seminars on product commercialization, intellectual property, business plan drafting, and microcredit financing, students are able to bridge the gap between the technical world and business world. Students work together in teams for growing their ventures, as well as meet regularly with instructors and local business leaders; further giving them the ability to enhance their soft skills and develop a sense of belonging. Initial assessments have revealed that students become more passionate about the subjects at hand, because they are able to establish a legacy that lasts beyond a simple classroom assignment. Furthermore, these are consistent with the ABET requirements that the 21<sup>st</sup> century engineer needs to have, both breadth and depth, to be prepared for challenges and complexities of the modern technological society.

### Introduction

Evidently, the globalizations of the economy, Internet connectivity, and exploding information technology have had a profound impact on modern societies.<sup>1, 2</sup> The modern society, and our everyday lives, are increasingly dependent on scientific and technical innovation.<sup>3</sup> Engineering, central to innovation, is dramatically influenced by the rapid changes that are taking place on a global scale. There has been much debate in recent years that traditional engineering education, however, does not adequately prepare the new graduates to face the ever-changing demands of technological societies. In a survey of engineering employers, conducted by Todd et al.<sup>4</sup>, the following frequently-cited perceptions of weaknesses of recent engineering graduates have been identified: *“technical arrogance, inadequate understanding of the manufacturing processes, lack of design capability or creativity, no appreciation for variation, narrow view of engineering and related disciplines, weak communication skills and little skill or experience in working in teams.”* On the other hand, Katehi, et al.<sup>5</sup> describe the work environment of the future graduates as: increasingly competitive in the global and knowledge-based economy, shrinking product life cycles, enterprise-oriented organization, increasing role of integrated engineering, sustainability

for natural resources, growing concern for biodiversity, etc. For the future engineering graduates to successfully compete in the aforementioned challenging work environments, *“they must have a world-class education, be equipped with the latest technical knowledge and tools, and have adequate understanding of the social, economic, and political issues that affect their work,”* confer Katehi et al.<sup>5</sup>

In response to the aforementioned challenges, Luryi, et al.<sup>6</sup> suggest: *“We believe one of the most powerful answers is entrepreneurship.”* According to Tryggvason and Apelian<sup>7</sup>, an entrepreneurial engineer of the 21<sup>st</sup> century will possess, with modest exaggeration, the following skills: (a) Knows everything – can quickly find information about anything and subsequently evaluate and use it. He/she will be able to transform information into knowledge; (b) Can do anything – have the know how to quickly assess what needs to be done, acquire the necessary tools, and use then tools proficiently; (c) Able to imagine and turn his/her imagination into reality – has the entrepreneurial mind set, the imagination, and managerial skills to identify needs, come up with effective solutions and implement them efficiently. Additionally, in a well-publicized report published by the National Academy of Engineering, entitled *The Engineer of 2020*<sup>8</sup> and its sequel, *Educating the Engineer of 2020*<sup>9</sup>, it has been noted that *“the engineering graduates should possess strong analytical skills, exhibit practical ingenuity, be creative, have good communication skills, be mastered in the principles of business and management, understand the principles of leadership, have a strong sense of professionalism and ethical standards, and be lifelong learners.”*

In recent years, many engineering programs have incorporated entrepreneurship as an integral component of their curricula. This paper presents an overview of the development of entrepreneurial activities within the Lyles College of Engineering (LCOE), in collaboration with the Lyles Center for Innovation and Entrepreneurship (LCIE), at California State University, Fresno (‘Fresno State’). The unique features of the Lyles Center for Innovation and Entrepreneurship, a recognized leader, will be described first. Next, experiences of Coleman Fellows and how they are promoting and integrating the entrepreneurship endeavors within their specific engineering and construction management disciplines will be discussed. A student entrepreneur ambassador and hatchery resident’s initiatives/experiences will be presented as well. The paper will conclude by highlighting the relevant ABET’s a through k student outcomes and how entrepreneurship activities address several student learning outcomes.

### **Lyles Center for Innovation and Entrepreneurship**

The Lyles Center for Innovation and Entrepreneurship aims to create value in three domains: (1) collegiate entrepreneurship education; (2) early childhood entrepreneurship education; and (3) regional economic development. To that end the LCIE operates a plethora of programs creating value in these spaces. The remainder of this section provides a brief overview of domains 2 and 3 for context, and then dives in depth into domain 1 as it’s directly related to the topic of this manuscript. The LCIE operates programs for students in the K-12 education system both formally as part of their in-class education (via partnership with local schools) and through extracurricular camps, events, and sessions. Annually, over 1,000 students spanning 20+ schools receive formal entrepreneurship education through LCIE programs. In addition, multiple revenue-generating summer camps, the occasional zoo day or Sunday school sessions, all are places that LCIE infuses creativity and innovation education opportunities for kids.

As the liaison between the university and the community, LCIE actively seeks to function as a catalyst for the regional entrepreneurship ecosystem. Annually, we host the Central Valley Venture Forum bringing together local businesses, venture capitalists, and expert entrepreneurs for a day of learning as well as highly competitive pitch competition. LCIE also houses a regional Small Business Development Center office and team of counselors and support staff whom are continually working to help aspiring and existing entrepreneurs grow their ventures. LCIE provides in-house seed stage financing and partners with meso-level venture capitalists to provide higher levels of funding support. The heart and soul of LCIE, despite all the activities noted above, is stimulating interdisciplinary entrepreneurial actions from both our own student base and from our feeder network of community college partners. Established nearly a decade ago, LCIE was formed as an independent center distinct from any one college with a mission of serving the entrepreneurial needs of all colleges. While LCIE is continually developing and implementing new programs and initiatives, there are several key staple programs to be noted:

*Formal degree curricula.* LCIE partners with the Craig School of Business to offer over 10 different entrepreneurship-specific accredited business courses. Students are able to earn a Bachelors of Science degree in Management-Entrepreneurship; a Minor in Entrepreneurship, or a certificate in Entrepreneurship. While the number of formal entrepreneurship majors has remained consistent over the past several years, non-entrepreneurship students enrolling in entrepreneurship courses has steadily increased each of the last 4 semesters, indicating non-business students are engaged and interested in learning entrepreneurial skills.

*Entrepreneurship across the curricula.* LCIE seeks to spread entrepreneurship across the curriculum in multiple ways. First, LCIE works in partnership with diverse disciplines to create interdisciplinary entrepreneurship certificate options for students. Two 2014 examples include certificates in Real Estate Entrepreneurship and Food Entrepreneurship. LCIE also partners with multiple other disciplines to apply for technology commercialization grants. In 2013, the Lyles College of Engineering (LCOE) and LCIE jointly applied for NCIIA grant support to create an interdisciplinary tech-to-market curriculum entitled “Innoventures”.

*Skill Development Workshops.* LCIE regularly offers skills development workshops geared toward advancing the entrepreneurial capacity of students and faculty. In 2013 LCIE ran multiple seed stage funding workshops attended by numerous faculty, and especially those in engineering. Two successful multi-thousand dollar awards resulted in late 2013 as a result of this effort. Sample skill development workshop topics include Intellectual Property Protection, Sales Skills and Prospecting, Demystifying Contracts, Applying for Grants, Entity Selection, and Forms of Ownership.

*Financing tech-to-market.* Via a strategic partnership with the Fresno State Foundation, LCIE facilitates the application and distribution process for a ~\$300,000 seed stage investment fund entity (viz., New California Ventures, LLC). Through this LLC the LCIE is able to provide varying levels of start up financing to proposed ventures, with award amounts ranging from \$1,000 for rapid prototyping to \$80,000+ for full roll out or development activity. This program was new in 2013 and investments are already flowing. Four awards have been made to date, three of which went to engineering students or student-faculty teams.

### **Entrepreneurship in Construction Management**

The construction industry has encountered major challenges during the last several years. As a result, today's construction industry is much different from what it used to be even four to five short years ago. There are fewer, but riskier and more complex projects. The prevailing difficulties of last several years have made it extremely challenging to succeed in the global economy. It is anticipated, however, that the global construction output will recover to grow 70 percent by 2025 – to \$15 trillion.<sup>10</sup> In view of aforementioned challenges and globalization, and in light of emerging construction technologies, the Construction Management (CM) Program in the Lyles College of Engineering at Fresno State has recently revamped its curriculum to better prepare future leaders of the construction industry. Accordingly, the CM program has incorporated leadership and entrepreneurship development as an integral part of this newly revised curriculum. The concepts are first introduced in the CM orientation course. Then, through faculty/industry professional mentorships, speaker series, student organization activities, and seminar series students are further exposed to the entrepreneurship ideas and get involved in leadership opportunities. Specific learning outcomes entail: providing students a rich learning experience and understanding how the construction business operates. Identifying the best practices of companies in terms of size, specialty, and minority ownership. Understanding various aspects of a start up such as planning, marketing, financial, legal, and human elements, as well as, acquisition or operation of a construction business from the entrepreneurial point of view. Learning how to launch and operate one's own construction enterprise or to take a leadership role in an existing construction firm or other related businesses. Moreover, developing critical thinking skills related to business, safety, quality control, management, leadership, and entrepreneurship practices.

### **Entrepreneurship in Civil Engineering**

Entrepreneurship is an essential opportunity for civil engineers to engage in infrastructure planning and development. The professional licensure is the main legal framework for civil engineers to act as entrepreneurs. Therefore, students are generally oriented to make the transition to professional engineers only few years after graduation. In the time between graduation and licensure, fresh graduates focus on obtaining technical knowledge and skills. Key resources during this period are continuing education and hands-on experiences. Thus, professional engineers often need to obtain additional knowledge and skills before making the second transition toward entrepreneurship. The Civil Engineering Practice and Entrepreneurship course in LCOE aims to combine such topics to enable students making the transition from student to entrepreneur-engineers after graduation. Both technical and non-technical components of civil engineering program already include basic knowledge and skills to achieve this goal. However, students need to learn how basic courses in humanity and social science, as well as business and economy, can empower them to be responsible-in-charge, and to develop and lead entities for innovation in infrastructures. Students at senior level or higher academic status are able to make the connection between such long-range goals and specialized fields of civil engineering. The course mentioned above includes introductory topics in civil engineering practice and entrepreneurship. These topics include business, economy, management, professionalism, leadership, and ethics. Discussions cover professional engineering, leadership theory and practice, project management, engineering economy, financial analysis, business, contracting and law, public policy and administration, and engineering ethics.

The “civil engineering practice and entrepreneurship” course focuses on the transition from student to professional engineer and from engineering to entrepreneurship. The specific characteristics of this course provide an opportunity for future civil engineers to engage in the full spectrum of infrastructure development, e.g., planning, design, and implementation, at private, public, or social entities. Further, this course addresses the strategic goals of ASCE, i.e., raise the grade on America’s infrastructure, raise the bar for future entry into professional engineering practice, and achieve a more sustainable and natural built environment.

### **Entrepreneurship in Mechanical Engineering**

As one of the broadest disciplines in engineering, mechanical engineering has been involved with many aspects of life. Talking about mechanical engineering, people immediately think about design. The products of this engineering discipline can vary from industrial machinery to residential consumer products. Vehicles, space stations, hydrostatic dams, air-conditioning systems and artificial organs are just very few examples of the wide variety of products mechanical engineers can produce. As the technology develops faster, the product requirements increases, the energy sources get more limited and the environmental friendliness is promoted more widely, entrepreneurial skills are crucial for mechanical engineers to be successful. Creativity is a must-have quality since the product competition is very high. In a global economy, all countries are trying to catch up in technical knowledge. Single functional products can no longer survive in the market. Functions are smartly and compactly included in products to be portable, affordable and convenient for users. Fortunately, engineers are highly adaptive to technology advancement. However, they still have to constantly innovate their products with available tools to be on top of the competition. Besides technically sound products, the engineers also need other critical aspects for their success. The design engineers have to understand the users’ needs profoundly while knowing how to attract the funding sources and making profit from product sales. In short, a successful mechanical engineer is required to have comprehensive knowledge in product engineering, social dynamics, economics, cultures, even psychology and more.

Seeing the challenge and opportunity, Mechanical Engineering department at Fresno State has been incorporating more entrepreneurship materials into its curriculum. One outstanding example is the Engineering Product Design course offered during junior/senior year that has been revised significantly. The course used to only teach students about the process of designing products. Recently, entrepreneurial contents have been added. Regarding the product design aspects, ergonomics and aesthetics have been stressed in the requirements of the designed products. Sustainability and recyclability are promoted strongly. Students are also taught project management skills to efficiently delegate tasks and complete them following a detailed schedule. Specially, funding source identification, business plan development and business projection are the topics receiving a lot of interest from the students. The base of a successful venture is the understanding of the market and economy. Therefore, engineering economics is covered extensively so that students are able to build their own business model with detailed projection based on certain financial condition. The project portion of the course is where students are free to come up with marketable products. In order to make sure the products are new and/or innovative, students are required to research the existing products through market, Internet and patents. Students are also encouraged to apply for seed funding to commercialize their products.



After completing this course, the students are able to develop products from the concept to delivery stage. They also know where and how to attract funding by writing effective business proposals. If starting the venture, the students know how to manage both the product development and business execution. Successful examples include the seed funding, up to \$5,000, by the New California Venture LLC awarded to two of the projects from this course offered in the Fall 2013 semester.

Entrepreneurship can also be promoted and infused in other courses of Mechanical Engineering curriculum such as theoretical or technical courses. Mechatronics course can be the place students apply their electromechanical knowledge into making consumer electronics. Radio-controlled toys are perfect examples for mechatronic projects. Students in Energy System Design course can think about commercializing the alternative energy technology. Obviously, solar panels and wind turbines are not only friendly to the environment but also utilizing the most abundant sources of energy. However, the main challenge is how to design and package the systems for residential usage. One would think that the theoretical courses such as Statics, Dynamics and Kinematics are difficult to promote entrepreneurship and innovation. If we look at the true learning outcomes of the courses, we will see otherwise. Students in these courses should be taught to design systems that function as required but use less materials and energy. If the projects are selected appropriately, for instance designing a packaging system, students will realize application of the knowledge into innovation of the existing industry. As a result, students in the courses are more motivated, engaged and confident about their knowledge. A great deal of viable ideas or concepts may result from the course projects. In modern education system, entrepreneurship contents will no longer serve as add-on. They will actually be the strength of the program that effectively boosts the knowledge level of both faculty and students.

### **Student Perspective – Experience and Leadership Initiatives**

Engaging engineering and construction management students through various entrepreneurial avenues are crucial to fostering future innovators and leaders. Engineers and construction managers must be able to understand the intricacies of market and business pressures<sup>11</sup>, particularly when conducting research and development (R&D) in a variety of areas. Many of the skills involved are highly sought out by employers. This is highlighted in a report published by the D.C. Children and Youth Investment<sup>12</sup>, whereby entrepreneurship education fosters improvements in academic performance, school attendance, problem-solving abilities, interpersonal relationships, and job readiness. Accordingly, Lyles College of Engineering and the Lyles Center for Innovation and Entrepreneurship have teamed to offer numerous extracurricular programs and campus organizations geared towards cultivating this knowledge base for the engineering and construction management students.

In the newly established Entrepreneurship Ambassadors (EA) program, the Lyles College of Engineering and College of Science and Mathematics' students work together to stimulate entrepreneurship. EA's are leaders in their respective fields, utilizing the available campus resources to promote entrepreneurship in innovation-based courses and activities. Coupled with excursions to Silicon Valley corporations, EA's have been able to relate the applicability of entrepreneurship education to students through seminars and personal interactions. The program further recognizes the premise that among those employed in the industry; engineering and physical science graduates are more likely to have obtained patents (38 and 37 percent,

respectively) than those in the remaining fields<sup>13</sup>. This data underscores the importance of promoting entrepreneurial drive and know-how in the undergraduate engineering curricula; for engineering students are the minds behind the R&D of breakthrough technologies that enhance the quality of life. Despite some initial obstacles, the EA program has proven to be fruitful for both the peer-mentors and engineering/construction management students. The mentors have been able to serve as coaches, servant leaders, and motivators, while the students have learned about being entrepreneurs, team players, and optimistic leaders.

According to a 2010 statistic by the U.S. Small Business Administration (SBA), there were nearly 28 million small businesses – 43 percent of which generated “high-tech” jobs. In response to similar preceding indicators, the Lyles Center for Innovation and Entrepreneurship has developed the hatchery program to promote student-based ventures. Utilizing resources such as mentors, smart classrooms, and technology, hatchery students are able to learn about entrepreneurship through experiential methods. They have partners, clients, employees, and deadlines, allowing them to hone their soft skills and business acumen in a semi-controlled environment. Engineering and construction management students benefit tremendously from these programs, designed to enhance their managerial and innovative skills. Furthermore, the newly formed International Organization for Developmental Entrepreneurship’s (IODE’s) is another endeavor, as a hatchery business, that provides engineering students the opportunity to interact with leaders from local industries and Community-Based Organizations (CBOs) to address the root causes of global poverty.

Adhering to the National Academy of Engineering’s “14 Grand Challenges,” IODE engineers implement the ideas of innovative sustainability to address the issues of unclean water in rural areas.<sup>14</sup> They work to achieve this through a variety of mediums. First, IODE serves as an organizing agent between Engineers Without Borders and Doctors Without Borders. These managerial engineers do this because they understand the correlation between health and infrastructure. While the doctors are treating the patients for water-related diseases, engineers are able to treat the water sources that are ridden with bacteria. IODE has been able to be ambitious because there have been plenty of opportunities for engineers to learn about entrepreneurship at Fresno State. This includes (but isn’t limited to) a supplementation of entrepreneurship courses, ventures through the Hatchery program, learning opportunities from business leaders and mentors, and business start-ups. As indicated by IODE’s President, entrepreneurship and engineering must synergistically work together to elevate human capital by developing sustainable solutions to socio-economic problems. The novelties of their project, along with their ability to unite students from all backgrounds, are two of the reasons why IODE has been accepted to the esteemed Clinton Global Initiative University summit.

## **Conclusions**

The partnership between the Lyles Center for Innovation and Entrepreneurship (LCIE) and Lyles College of Engineering (LCOE) has created extraordinary opportunities for the faculty and students and the experiential entrepreneurship activities have been remarkable. Coleman Fellows have been able to either develop and offer new entrepreneurial type of courses or revise existing ones with an entrepreneurship emphasis. Students are going beyond the traditional conceptual design and are now engaged in the actual project delivery and commercialization. Furthermore, the extracurricular activities, hatchery business opportunities, and founding of the

International Organization for Developmental Entrepreneurship (IODE) have all infused excitement and a contagious culture of engineering entrepreneurship within LCOE.

Entrepreneurship education also addresses several ABET student outcomes a-k. Specifically, the following criteria directly relate to various entrepreneurship activities:

- (d) an ability to function on multidisciplinary teams
- (e) an ability to identify, formulate, and solve engineering problems
- (f) an understanding of professional and ethical responsibility
- (g) an ability to communicate effectively
- (h) the broad education necessary to understand the impact of engineering solutions in a global, economic, environmental, and societal context
- (i) a recognition of the need for, and an ability to engage in life-long learning
- (j) a knowledge of contemporary issues
- (k) an ability to use the techniques, skills, and modern engineering tools necessary for engineering practice.

These are incorporated as part of the on-going assessment process in engineering programs at LCOE.

## References

1. Friedman, T.L., *The World is Flat: A Brief History of the Twenty-First Century*, Farrar, Straus and Giroux Publishers, 2007, 660p.
2. Weaver, J., Rayess, N., "Developing Entrepreneurially-Minded Engineers by Incorporating Technical Entrepreneurship Case Studies," *the Journal of Engineering Entrepreneurship (JEEN)*, Vol. 2, No.1, Winter 2011.
3. "Moving Forward to Improve Engineering Education," National Science Board, 19 November 2007, 58p.
4. Todd, R.H., Sorensen, C.D., and Magleby, S.P., "Designing a Capstone Senior Course to Satisfy Industrial Customers," *Journal of Engineering Education*, Vol. 82, No. 2., 1993, 99 92-100.
5. Katehi, et al. "A New Framework for Academic Reform in Engineering Education," *Proceedings of the American Society of Engineering Education Annual Conference and Exposition*, 2004.
6. Luryi, S., Tang, W., Lifshitz, N., Wolf, G., Doboli, S., Betz, J.A., Maritato, P., and Shamash, Y., "Entrepreneurship in Engineering Education," *Proceedings of the ASEE/IEEE Frontiers in Education Conference*, 10-13 October 2007, Milwaukee, WI, pp10-15.
7. Tryggvason, G. and Apelian, D., "Re-Engineering Engineering Education for the Challenges of the 21<sup>st</sup> Century," *Commentary in JOM: The Member Journal of TMS*, October 2006. Reprinted in *IEEE Engineering Management Review*, 37(1), 2009, 38-43.
8. NAE (National Academy of Engineering), "Engineer of 2020: Visions of Engineering in the New Century," The National Academies Press, 2004, Washington, DC, 119 p.
9. NAE (National Academy of Engineering), "Educating the Engineer of 2020: Adapting Engineering Education to the New Century," The National Academies Press, 2005, Washington DC, 209 p.
10. Jones, J., "Global Construction to Jump 70 Percent by 2025," *Civil Engineering Magazine*, Published by the American Society of Civil Engineers (ASCE), August 2013.
11. Nelson AJ, Byers T. 2010. *Challenges in University Technology Transfer and the Promising Role of Entrepreneurship Education*. Kauffman: Emerging Scholars Initiatives
12. *Logic Models and Outcomes for Youth Entrepreneurship Programs*, DC Children and Youth Investment Trust Corporation (2001).
13. National Science Foundation, Division of Science Resources Statistics, 1995 and 2001 Survey of Doctorate Recipients.
14. NAE (National Academy of Engineering), "Grand Challenges for Engineering in the 21<sup>st</sup> Century," Accessed at: <http://www.engineeringchallenges.org/> on January 17, 2014.

## **Structuring Technical Capstone Projects for Non-Profit and Low-Budget Community Organizations**

Bhaskar Sinha, Pradip Dey, Gordon Romney,  
Mohammad Amin, and Debra Bowen  
National University

### **Abstract**

Students in most technical programs work on original capstone projects that integrate and synthesize concepts and principles that are taught throughout the program. These capstone projects or practicums are usually the last course in the program. At our institution, School of Engineering and Computing (SOEC), National University, many technology-based capstone projects are undertaken every year, where students define, design and implement projects in the areas of Computer Science, Information Technology, Wireless Communications, and Cyber Security. Structuring and customizing some of these projects for non-profit or low-budget start-up organizations will have significant positive impact in our local community and enhance the institution's vision of providing useful community service. This vision of providing quality community service is supported by the university leadership and practiced by faculty and staff. Designing and implementing these projects enables hands-on practical experience for our students, thus creating a win-win situation for both the community and the students. Most of these capstone projects are completed with minimal budget and within an intensive short duration of time: two to three months as delivered in SOEC at National University. This study identifies criteria and determines ways to structure technical capstone projects to make them effective and beneficial to the community, and provide a valuable real-world learning experience to students. Two projects, one for a non-profit organization and the other for a privately owned low-budget local business, are selected and analyzed to support the hypothesis that quality community projects can be undertaken and completed with low-budget and time constraints. The results clearly demonstrate that this is a viable and practical way to enhance the vision of providing useful service to the community, improving student learning, and at the same time, meeting all required learning outcomes of the academic program.

### **Introduction**

Programs at National University (NU) School of Engineering and Computing (SOEC) are professional degrees that integrate communication methods, problem solving skills, simulation techniques and mathematical fundamentals with hands-on experiences required to solve real-world industry problems<sup>1,2</sup>. They are designed for professionals and managers to promote the learning and application of skills in their respective fields, and use curriculums that emphasize multidisciplinary knowledge. These programs combine theory, lectures, hands-on work, projects, research papers and presentations. They also require students to complete a capstone project in their final year, or upon program completion, as a concluding experience to determine the students' ability to apply program knowledge and skills to real-world problems<sup>3</sup>. This research demonstrates that creating and implementing capstone projects for non-profit and low-budget community organizations is both a viable and practical way to enhance the vision of providing useful service to the community, improving student learning, and at the same time, meeting all required learning outcomes of the academic program.

Literature suggests that a capstone or practicum is a unique end of the program experience that promotes students' capacity to implement their completed coursework and use the knowledge and skills they have learned<sup>3,4,5</sup>. Different academic programs structure capstone projects with distinctive objectives<sup>5</sup>. This paper analyzes community projects in the Bachelor of Science in Information Technology Management (BS-ITM) academic program for non-profit and low-budget organizations in the technology space. Past available work describes approaches and recommendations for designing successful capstone projects<sup>6,7</sup> including the benefits of promoting reflection and critical thinking<sup>8,9</sup>. Most of these past works focus on the value of capstone projects to the students learning and experience, but little work is available on the value to the community organizations who actively work with students in these capstone projects and the extent to which these efforts are a value-add to the sponsoring organizations<sup>10</sup>. These organizations are interested in the capstone project for specific business reasons<sup>11</sup>, as a source of inexpensive, mostly free, technical resource that facilitates capstone completion in situations where it might not be otherwise possible<sup>8,11</sup>. The projects also provide organizations with an opportunity to contribute to student learning<sup>11,12,13</sup> and to cultivate good citizenship and collaborative service<sup>11</sup>. By working with the community, students experience real-world social, economic, and cultural boundaries, and enhance their understanding of racial, economic, and social differences and similarities in society<sup>14</sup>.

This paper is an analysis of two capstone projects for the BS-ITM academic program: Cox YMCA (three students in the project group) and EazyToyz (four students in the project group). It determines how the projects fulfill the BS-ITM Program Learning Outcomes (PLOs) and provide useful service to the community – especially, to the low-budget and non-profit organizations that have limited financial resources.

### **Capstone Project 1: Cox Tech Center Upgrade at YMCA Youth & Family Services<sup>15</sup>**

This project for a non-profit organization consists of upgrades and modifications to the Cox Tech Center lab at the YMCA of San Diego County – Youth & Family Services Department (YFS). This involved the upgrade process from the existing legacy network infrastructure to a more robust network solution that utilizes newer technologies. At the core of the upgraded network were two servers running Windows Server 2008 R2 configured to provide redundancy and various services to the Cox Tech Center and its users. Among the added functionality was the use of Microsoft's Hyper-V for virtualization along with the deployment and configuration of Microsoft System Center Essentials 2010 for centralized network management. The design and implementation began with an analysis of the pre-upgrade network infrastructure and an assessment of the services offered through the center. It was followed by the vision held by the YFS staff to provide enhanced technology services to an underserved community. This vision was then translated into a network infrastructure upgrade of the Cox Tech Center that met the diverse needs of its users. Problems were identified, and best practices and more effective methods of using newer technologies were deployed to address the deficiencies. This process led to the implementation of an effective solution while using available resources. The organization chart involved the Cox Tech Center lab, National University faculty, and the Capstone students. Their working relationships and the reporting structure is shown in Figure 1.

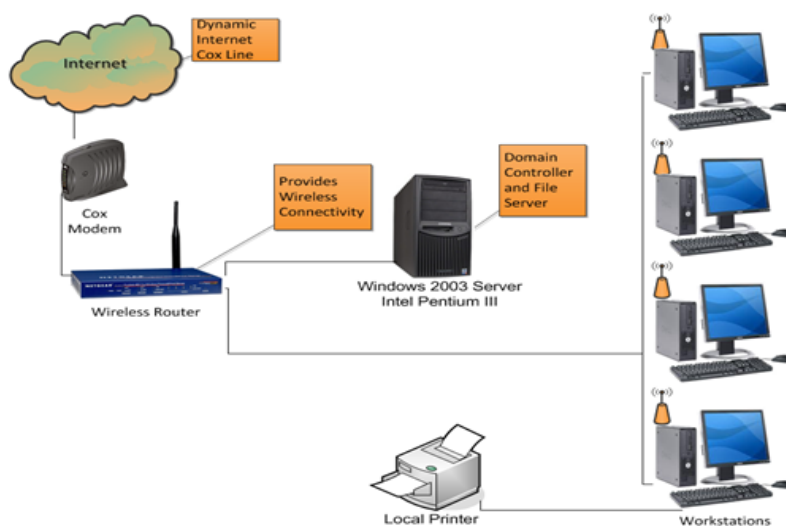
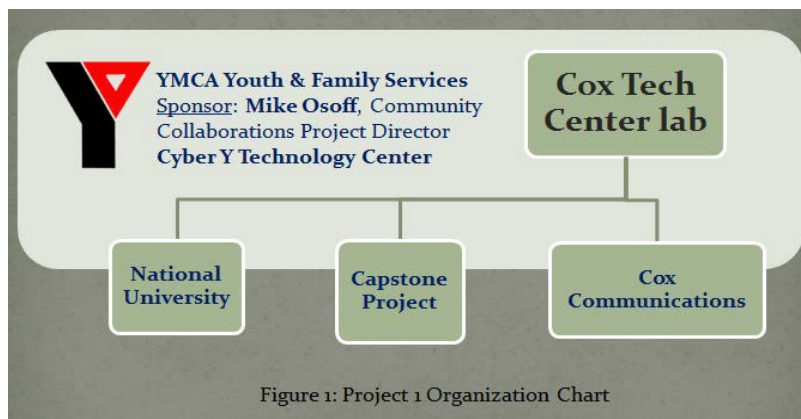
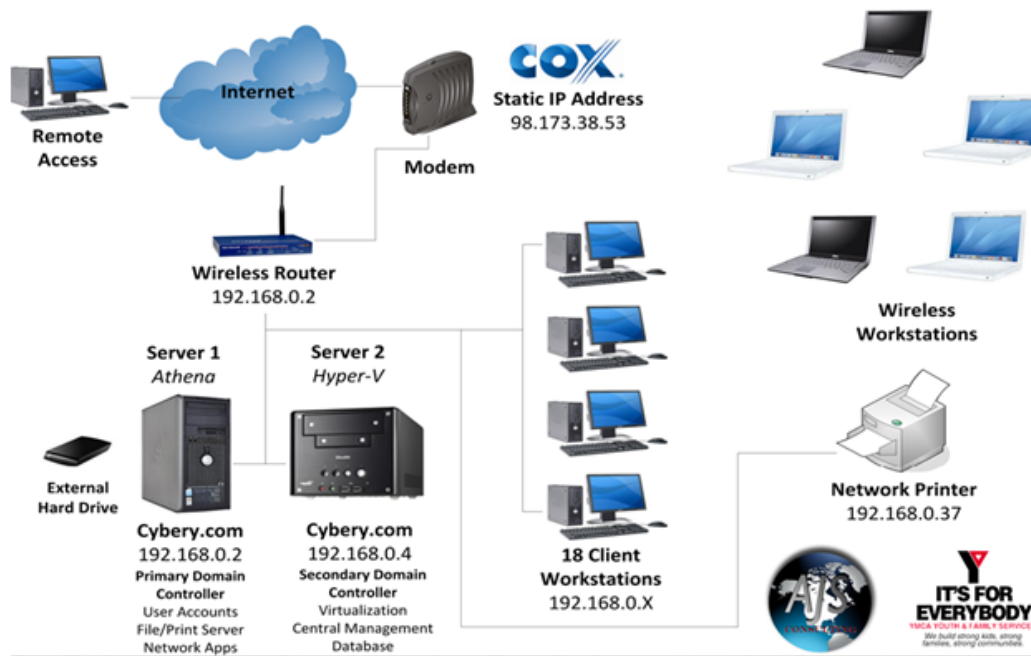

Figure 2 shows the pre-upgrade physical description of the network as determined by the project team during the initial evaluation. Internet service was provided through a dynamic service communication line coming into the facility, which hindered remote connectivity options. The existing Netgear wireless access point, which offered many advanced features, was not being used to its full functional capacity. The server, being used as the Primary Domain Controller, was classified as a legacy device due to hardware specifications and configuration. Additionally, the system was running an outdated Window Server operating system.

# Network Design & Configuration



**Figure 3: Project 1 Post-Upgrade Physical Description**

The scope of this project was to 1) include upgrades limited to the Cox Tech Center lab, 2) migrate data and network programs from a legacy server to a more robust system, 3) install a centralized network management system, 4) implement a solution that could be managed by non-IT staff with minimal training, 5) provide a virtualization prototype that utilizes thin client Wyse terminal, 6) create a network use policy, 7) implement a working prototype that delivered the added functionalities, and 8) provide staff with training

Figure 3 shows the design of the upgraded network, providing an overview of the core services offered by two servers, Server 1 and Server 2. Server 1 “Athena” was the hub of the network (Windows Server 2008 R-2). It was the Primary Domain Controller with Active Directory (Group Policy) using Dynamic Host Configuration Protocol (DHCP). Responsibilities included serving as the File and Print Server, Network Drives, and Network Applications (DeepFreeze & TypingMaster). Server 2 “Hyper-V” served as the Virtualization and System Management (Windows Server 2008 R-2) server with roles as the Redundancy and Secondary Domain Controller, the Hyper-V Virtualization, and the System Center Essentials 2010. This project design and implementation met all the client acceptance criteria.

## Capstone Project 2: EazyToyz Modernization<sup>16</sup>



**Figure 4: Project 2 EazyToyz Archaic Sales System**

EazyToyz, a low-budget organization, is a small family owned retail shop that specializes in Southern California NFL and MLB merchandise (Dodgers, Raiders, Padres, and Chargers). They also have a small selection of skateboard equipment, sports novelty items, and an assortment of everyday clothing. A few years ago the owners of the store contacted a local IT company requesting a technology update of their cash register, a computerized database, better wireless security for their store, and the ability to make secure transactions on their webpage. The cost estimate was greater than what they could afford so NU students stepped in to help by providing these tools to the store on a much more acceptable budget.

The legacy system in place required excessive man hours that could be reduced by using a computerized cash register with a database that updates inventory dynamically when a sale is made. Four levels of technical growth were needed within the EazyToyz company: (1) a functional database used to store inventory, (2) a Point of Sale (POS) system with the database to track merchandise sold, purchased, or returned to the manufacturer, (3) to secure the wireless network to prevent attacks, and (4) to provide either a secure site for online sales, or utilize the capabilities of a third party vendor. The store had been operating for over ten years and had not upgraded its technical footprint since opening. POS Maid, an inexpensive, powerful solution was implemented to use on an available desktop computer as the new cash register. POS Maid includes a dynamic database with options for payroll and employee hourly tracking. The EazyToyz website sales were previously low due to an absence of an integrated process and lack of security. The financial solution recommended the use of the PayPal system. The previous wireless router had inadequate security and the proposed solution recommended enhanced wireless security features. All of the features utilized in the implementation phase of this project were of minimal cost to the customer. A database repository was created which allowed store management to make real-time queries or reports on available merchandise, and the ability to complete a customer's request, or determine out-of-stock items that needed to be ordered. The existing Point of Sale and barcode system was enhanced so that inventory would no longer be "lost". The original cash register required manual input, did not log all items sold, and printed receipts could not be considered reliable for items that needed to be returned. The Point of Sale



system selected and implemented was POS Maid that met all requirements. The original wireless router did not need to be replaced but was modified to use an already included strong encryption, WPA-2. Enterprise security firmware, the latest version of Tomato, was also implemented.



**Figure 5: Project 2 EazyToyz Point-of-Sales System and Secured Wireless Network**

The router was configured for MAC filtering which only allows devices with specific MAC addresses to be recognized and allowed on the router. In addition, all workers were trained on the basics of network security and the prevention of data loss. This ensured a safe environment preventing attacks that are costly to any business and cause downtime needed to restore the system, or hours spent contacting the credit card companies and customers to inform them of the security breach. The implemented POS system and the secured wireless network are shown in Figure 5.

At the beginning of this project, EazyToyz had a functioning website that supported purchases. Upon reviewing the POS process and website it was evident that it was not secure by the missing “lock” in the URL block, and the missing “s” after HTTP. Once payments via PayPal were implemented online sales immediately increased as customers gained confidence when making secure purchases. As a matter of fact the entire website look and feel was enhanced. The original site was not user friendly as it showed merchandise that was no longer in stock as “available”. The modified user friendly website is shown in Figure 6. This project met all the client acceptance criteria which at project initiation were defined as 1) gaining customer confidence by securing the sales transaction, 2) improving profit by installing network security,, 3) increasing revenue by reducing labor costs, and 4) provisioning a database that allows management of an accurate inventory.

### **Academic Analysis of the Capstone Projects**

The NU BS-ITM program is a professional curriculum based on modern Information Technologies (IT) and IT management techniques. It facilitates students to learn analysis,

problem solving techniques, advanced IT design, and IT management. The mission of the

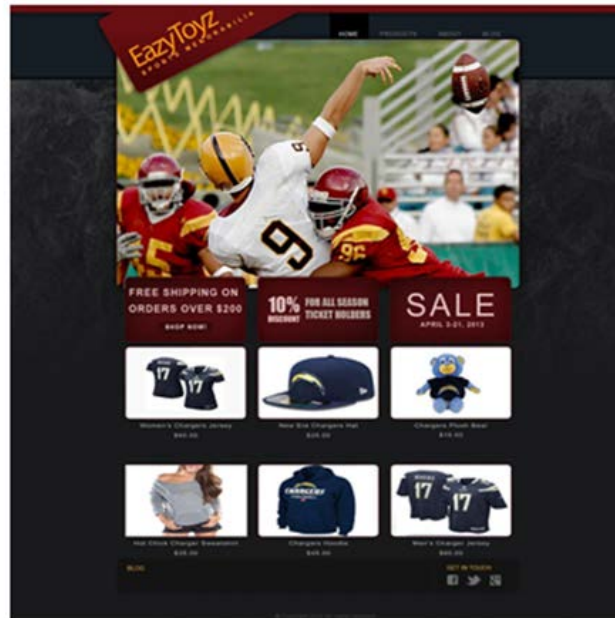

**Figure 6: Project 2 EazyToyz User Friendly Website**

program is reflected in the Program Learning Outcomes (PLOs) as follows (ref: [www.nu.edu](http://www.nu.edu)):

1. Demonstrate an ability to set up and integrate local and remote server and workstation computers with proper user authentication to preserve user privacy and confidentiality.
2. Demonstrate the ability to plan an integrated system that involves computer applications to satisfy specific business processes.
3. Demonstrate, manage and administer a LAN and wireless networking environment.
4. Design, develop, administer, and support a robust relational database management system.
5. Apply concepts of best practices in information technology management and security to enterprise processes.
6. Describe the ethical challenges that confront an IT professional
7. Demonstrate written and oral communication skills in collaborative environments by participating on teams that address solutions for IT management challenges.

In this BS-ITM program, students learn theory, principles, and hands-on activities in the discipline through twelve one-month duration courses. At the end of the program, all students are required to take two project classes that constitute the capstone project, which allow them to apply technology to problem solutions in various new and innovative applications. Designated PLOs are achieved at the conclusion of the two project classes that span three months: ITM490A and ITM490B. Group work is encouraged and students are encouraged to work in teams to gain valuable experience needed in industry environments. In the first month, students form teams of 2 to 4 students per team, make project management assignments, select research topics, conduct literature searches, analyze process challenges, and develop a plan to reach a viable solution. In the second and third months students 1) perform the necessary tests/experiments, 2) collect data, 3) create a prototype, 4) prepare project reports, 5) give a formal presentation, and 6)

demonstrate a prototype or actual working project solution. All BS-ITM capstone projects and capstone projects in other SOEC programs are subject to assessment by a Faculty Judging Panel (faculty members and industry professionals) using an “Assessment of Learning Outcomes” shown in Figure 7, that contains all the assessment criteria and metrics.

### **Validation of the Capstone Projects**

In both of these BS-ITM capstone projects (Project 1 and Project 2), a detailed and in-depth literature review was conducted by the students in order to identify the main user requirements, and identify a practical cost-effective solution that could be implemented in the limited three-month time period available. The Judging Panel, after reviewing the written capstone reports, participating interactively with the students during the project presentations, and scoring the projects using the assessment rubrics, submitted their individual evaluations to the BS-ITM Program Lead faculty. Grades were assigned for a project, not for individual team members. Each team member in a particular project received the same grade. The summary of these evaluations for these projects are shown in the Figure 7. The Panel concluded that the students did well in their projects, and gained appropriate program level knowledge and practical experience in the field. Note that the evaluation form in Figure 7 has the old name of the school, School of Engineering, Technology and Media (SETM). This name was recently changed to School of Engineering and Computing (SOEC). The possible grades assigned for capstone projects in the BS-ITM program are: H – Honors, signifies outstanding achievement, S – Satisfactory, signifies acceptable achievement, and U – Unsatisfactory, signifies unacceptable achievement. No grade points are assigned for these capstone projects. Each student in these two projects received the H grade.

### **Conclusions**

Two capstone projects, one for the YMCA, a non-profit organization, and the other for EazyToyz, a privately owned low-budget local business, were selected and analyzed to support the hypothesis that quality community projects can be undertaken and completed with a low-budget and three-month capstone time constraint. **Prototypes of the two projects were designed, developed, and tested by students under the guidance of faculty members.** Goals, with regards to each project and meeting the program PLOs, were accomplished. Each project was successfully demonstrated to an audience comprised of representatives of the sponsoring institution, students and their families, and National University faculty and staff. Based on the successful demonstrations of the project prototypes, the students were assigned appropriately high grades. **Each project was also analyzed on the degree to which it met the program learning outcomes. Students made a formal presentation to a Faculty Judging Panel that provided an evaluation** based on an assessment rubric. The Panel, in turn, presented its findings to the BS-ITM Lead Faculty who gave official grading of each capstone project and the project was approved for the BS-ITM degree requirement. This paper gives an academic analysis of the capstone project process, and determines how it reinforces the academic objectives of this program and individual Program Learning Outcomes (PLOs), as established at NU. These findings demonstrate that the capstone project is a practical way of providing beneficial service to the community, improves student learning, and meets all required learning outcomes of the academic program.

NATIONAL UNIVERSITY				
School of Engineering, Technology and Media				
Assessment of Learning Outcomes by Faculty Judging Panel				
Academic Program: Bachelor of Science in Information Technology Management				
Information Technology Project I and II [ITM490A and ITM490B]				
PLO	Program Learning Outcomes	Assessment Criteria and Measurable Outcomes	TEAM GRADE [25 MAX]	
			Project 1	Project 2
1	Demonstrate an ability to set up and integrate local and remote server and workstation computers with proper user authentication to preserve user	Report	22	20
		Prototype Demonstration	22	22
		Presentation	23	23
2	Demonstrate the ability to plan an integrated system that involves computer applications to satisfy specific business processes.	Report	22	24
		Prototype Demonstration	23	23
		Presentation	20	21
3	Demonstrate, manage and administer a LAN and wireless networking environment.	Report	23	25
		Prototype Demonstration	22	20
		Presentation	24	23
4	Design, develop, administer, and support a robust relational database management system.	Report	23	22
		Prototype Demonstration	21	24
		Presentation	23	25
5	Apply concepts of best practices in information technology management and security to enterprise processes.	Report	21	20
		Prototype Demonstration	22	25
		Presentation	24	23
6	Describe the ethical challenges that confront an IT professional	Report	23	21
		Prototype Demonstration	20	22
		Presentation	24	24
7	Demonstrate written and oral communication skills in collaborative environments by participating on teams that address solutions for IT	Report	23	22
		Prototype Demonstration	23	21
		Presentation	22	22

Figure 7: PLOs and Project Grading for Project 1 and Project 2

### Recommendations for Future Research

The process of contacting community organizations and understanding their requirements needs to be improved and automated. The authors are evaluating the feasibility of creating a web site where member organizations can log in and post their requirements for projects. Currently, students and faculty spend considerable time seeking and then discussing with community organizations to determine who has a technological need and is willing to work with our students to define and collaborate in capstone projects. With a web site, students may more easily identify potential projects, analyze the need with the clients, and request assignment to a specific project. These requests, in turn, can be reviewed by instructors and students, and the appropriate assignments can then be made.

### Acknowledgements

The authors thank our NU students who worked on these two capstone projects<sup>15,16</sup>, and gratefully acknowledge the help and encouragement received from the judging panel members and other faculties at National University, School of Engineering and Computing, during the continuing research on this subject and the preparation of this paper.

## References

1. 2014 National University General Catalog V77. Master of Science in Wireless Communication. Retrieved from <http://www.nu.edu/OurPrograms/SchoolOfEngineeringAndTechnology/AppliedEngineering/Programs/720-816.html>
2. Jenefsky, C., Bresciani, M., Buckley, L., Fairris, D. & Kasimatis, M. (2009, September). WASC Resource Guide for “Good Practices” in Academic Program Review. Western Association of Schools and Colleges. [http://www.wascenior.org/findit/files/forms/WASC\\_Program\\_Review\\_Resource\\_Guide\\_Sept\\_2009.pdf](http://www.wascenior.org/findit/files/forms/WASC_Program_Review_Resource_Guide_Sept_2009.pdf)
3. Campbell, D.A., Lambright, K.T. How valuable are capstone projects for Community Organizations? Lessons from a Program Assessment. *Journal of Public Affairs Education (JPAAE)*, 17(1), 61-87.
4. Garris, R., Madden, J., and Rodgers, W.M. III (2008). Practitioners’ roles, internships, and practicum courses in public policy and management education. *Journal of Policy Analysis and Management*, 27, 992-1003.
5. Jennings, E.T. (2003). Capstone project symposium. *Journal of Public Affairs Education*, 9, 43-44.
6. Allard, S.W., Straussman, J.D. (2003). Managing intensive student consulting capstone projects: The Maxwell School experience. *Journal of Policy Analysis and Management*, 22,689-701.
7. McGraw, D., Weschler, I. (1999). Romancing the capstone: The jewel of public value. *Journal of Public Affairs Education*, 5, 89-105.
8. Bushouse, B.K. (2005). Community nonprofit organizations and service learning: Resource constraints to building partnerships with universities. *Michigan Journal of Community Service Learning*, 12, 32-40.
9. Bushouse, B., Morrison, S. (2001). Applying service learning in Master of Public Affairs program. *Journal of Public Affairs Education*, 7, 9-17.
10. Schachter, D.R., Schwartz, D. (2009). The value of capstone projects to participating client organizations. *Journal of Public Affairs Education*, 15, 446-461.
11. Bassinger, N., Bartholomew, K. (2006). Service learning in nonprofit organizations: Motivations, expectations, and outcomes. *Michigan Journal of Community Service Learning*, 12, 15-26.
12. Gelmon, S.B., Holland, B.A., Seifer, S.D., Shinnamon, A., Connors, K. (1988). Community-university partnership for mutual learning. *Michigan Journal of Community Service Learning*, 5, 97-107.
13. Sandy, M., Holland, B.A. (2006). Different worlds and common ground: Community partner perspectives on campus-community partnerships. *Michigan Journal of Community Service Learning*, 13, 30-43.
14. Worrall, L. (2007). Asking the community: A case study of community partner perspectives. *Michigan Journal of Community Service Learning*, 14, 5-17.
15. Valdez, A., Grace, J., Sithiporn, S. Capstone project (2011): Cox Tech Center Upgrade at YMCA Youth and Family Services. National University, Bachelor of Information Technology Management, National University, California, USA.
16. Tapia, D., Arjona, D., Wallace, J., Brinkman, J. Capstone project (2013): EazyToyz Modernization. National University, Bachelor of Information Technology Management, National University, California, USA.



**April 24 – 26, 2014 | Long Beach, California**  
ASEE Zone IV: Pacific Northwest, Pacific Southwest, and Rocky Mountain

# POSTER ABSTRACTS

## **Teaching HVAC/R in a Learn by Doing Mechanical Engineering Program Using Industrial Training Equipment**

Kevin Anderson, Sam Halstead, Rafi Karim, Kakeru Berg,  
Felix Monteroso, Trinh Pham, and Chris McNamara  
California State Polytechnic University, Pomona

This poster will present the results of teaching the ME 418 “Heating Ventilation, Air Conditioning & Refrigeration (HVAC/R)” course at Cal Poly Pomona using Hampden Industries Industrial Trainer apparatus for laboratory supplements. Recently, the Mechanical Engineering department at Cal Poly Pomona was awarded a grant by Southern California Edison (SCE) which tasked the university to become a center which fostered industrial education in the arena of HVAC/R. To meet this challenge, the Cal Poly Pomona Mechanical Engineering program has allied itself with the Western HVAC Performance Alliance. The Western HVAC Performance Alliance is an advisory board formed at the direction of the California Long Term Energy Efficiency Strategic Plan specifically to provide the California Utilities with expert counsel from the heating, ventilation and air-conditioning industry. Members of the Western HVAC Performance Alliance meet and work with a broad set of HVAC experts representing all aspects of the industry, together tackling the issues and the opportunities surrounding energy efficiency. As a member of the Western HVAC Performance Alliance, Cal Poly Pomona’s Mechanical Engineering program is at the forefront of redefining the training and educational aspect of the Southern California regional HVAC/R industry. To this end, Hampden Industries HVAC/R industrial training units have been acquired with the SCE grant funding, and since have been rolled out in the ME 418 Laboratory in order to develop curriculum in support of the educational goals and initiatives of the Western HVAC Performance Alliance. Our poster will present the results of this curriculum development in the form of a “hands-on” based “learn-by-doing” set of laboratory experience developed around the implementation of the Hampden Industries HVAC/R industrial training units in the laboratory. The main purpose of a Heating, Ventilation, Air-Conditioning and Refrigeration (HVAC&R) system is to help maintain acceptable indoor air quality through adequate ventilation with filtration and provide thermal comforts.

## **Student Engagement in STEM Careers Early on through Engineering Clubs at a Middle & High School: Teacher Practices from the Trenches**

Mehmet Argin, Ahmet Uludag, and Shohrat Geldiyev  
Magnolia Public Schools/ Cisco Learning Institute/ Pacific Technology School

The U.S. Bureau of Labor reports indicate that the number of jobs in engineering and science will grow at more than three times the rate of other careers. By 2018, the bulk of STEM jobs will be in computing (71%) followed by Traditional Engineering (16%), Physical Sciences (7%), Life Sciences (4%) and Mathematics (2%). 43% of those STEM jobs will be in engineering. American universities, however, only award about a third of the bachelor’s degrees in science

and engineering (Carnevale, Smith, & Strohl, 2010). Despite this high demand, there is approximately 40 percent to 50 percent attrition rate among engineering students due to mainly three key reasons: poor teaching and advising; the difficulty of the engineering curriculum; and a lack of “belonging” within engineering (Matthews, 2012). The key question is how this attrition rate can be lowered through an early on preparation and motivation in middle and high schools. Yet, there is improvement in K–12 engineering education in U.S. K–12 classrooms. Variety of engineering programs and curriculum are being offered in schools around the nation. In the last two decades, engineering education has been delivered to K-12 students and many teachers have attended professional development trainings to learn how to teach engineering-related classes (Katehi, Pearson, & Feder, 2009). In this study, we explore the effect of engineering clubs such as VEX robotics, FIRST Lego League, Cyber, and JPL invention challenge on middle and high school students’ interest on engineering profession. In this qualitative study, we investigate how these clubs motivate and engage students in engineering concepts and change their perception about engineering career. The significant contribution of this research is to explore the role of these clubs on students’ desire to choose engineering career path.

### **Cause of *Gordonia amarae*-like Foaming in an Incompletely Nitrifying Plant: 3.5 Year Study**

Pitiporn Asvapathanagul, Zhonghu Huang, Phillip Gedalanga,  
Tracy Wallace, Jim Pullen, and Betty Olson

California State University, Long Beach/ Nanjing University of Science and Technology/  
University of California, Irvine/ University of California, Los Angeles/  
Chiquita Water Reclamation Plant

The first foaming incident at Chiquita Water Reclamation Plant (CWRP) was observed in spring 2009 and foaming episodes have reoccurred several times. *Gordonia amarae*-like bacteria created foam at this plant. The foaming incidents were not restricted by temperature (22 to 29°C). Dissolved oxygen concentrations (DO) and solids retention time (SRT) had no relationship with the foaming incidents. However, A drop in BOD concentration in primary effluent < 100 mg/L, preceded when *G. amarae*-like bacteria were first detected using qPCR in December 2008, detected using PCR-RLB in July 2009, and increased in concentration in August and November 2011 using qPCR. After that, foams were observed. Although, the molecular data are not available during 2010 and the beginning of 2011, low BOD concentrations (<100 mg/L) were observed within one month of foaming events (Figure 1). When the BOD concentrations in primary effluent increased or returned to the average value the day after a decrease, *G. amarae*-like cell concentrations continued to increase. When BOD concentrations were lower than 100 mg/L, *G. amarae*-like bacteria began to grow, regardless of temperature, SRT and F/M ratio. Lemmer, H (1986) found actenomyces producing scum can switch their growth strategies. When available substrates are limited, they use  $K_s$  – strategy, allowing this group to maintain a stable background concentration. However, when high concentrations of substrates are available, they will significantly increase their concentrations ( $\mu_{max}$  strategy). Our result shows after restricted BOD concentrations in primary effluent had been observed (BOD<100 mg/L), *G. amarae*-like cell concentrations started increasing. Monitoring substrate concentration in primary effluent is crucial in order to give a pre-warning signal before a full foaming episode occurs.



## **Multidisciplinary Robotic Arm Project**

Fernando Ayon-Serrato and Cathy Sakurai  
California State University, Long Beach

Robotics has become the center point for many Schools of Engineering around the world. Projects have sprung up across the U.S. with a simple yet challenging goal, building a functional and affordable robotic arm. Our poster will propose a new standard of how institutes and organizations may run their robotic arm projects. We will present an multidisciplinary project that will not only allow students to broaden their engineering knowledge but engage them in industry standard practices. Our robotic arm project will be split into three main divisions: Mechanical, Electrical and Computer Science/Engineering. Each division will be responsible for a different area of the project but will need to be in constant communication with each other so that the final product will function as designed. The Mechanical division will be responsible for the CAD of the entire system; this includes the functionality, placement of components and the production of components with the use of a 3D printer. The Electrical division will be responsible for drawing the electrical schematics, planning how the system will operate and wiring the system together. The Computer Science/Engineering division will be responsible for developing the code to run the robotic arm, implementing embedded systems and tuning the system to run seamlessly. A 'Division Head' will run each division and will delegate tasks to ensure responsibilities are being met. These Division Head's will report to two 'Project Managers' that will head the project. Everyone will have an equal say in the design and production of the robotic arm. Leadership roles will be selected by election within each division and will have equal, if not more, responsibilities. The first of these projects will begin in Winter 2013 and span till Spring 2014. Once the first robotic arm (hereinafter alpha arm) is completed and functional, two more projects will begin. Of these two, incoming freshman will be given the opportunity to join and be mentored by upper division students who completed work on the alpha arm.

## **Solar Powered Alternator**

Michael Balagtas, Ravipun Cherngchaosil, Cody Dunn, and Omar Rojas  
California State University, Long Beach

The purpose of the project was to utilize renewable energy sources to address the lack of electricity in third world countries. This issue was addressed through the development of a bicycle and solar powered alternator. The primary source of energy is the mechanical pedaling by a cyclist, although the small solar panels do contribute solar energy to help with the initial voltage requirements of the alternator. The spinning of the wheel spins the alternator to generate useful electricity that can be utilized to power necessary devices frequently used in developing countries. Almost all of the materials used were recycled, making the bicycle a cheap and viable energy source for poorer citizens. The primary component of the machine is a modified vehicle alternator salvaged from a destroyed vehicle in a Pick a Part junk yard. The alternator was utilized to take full advantage of the component's recharging capabilities; most of the other machine's components serve to accommodate the function of the machine supplying the necessary initial current. The magnetic field from the current will create an ad hoc generator that

is powered by a V-belt attached to the rear wheel of a bicycle. The machine outputs various voltages depending on cycling speed and the amount of sunlight available. The solar panel outputs 4.335V when directly exposed to moderate sunlight and 3.21V at a vertical angle (which is more common), yielding 0.122 mW. The total machine outputs 13.79W when the panel is exposed to moderate sunlight with a moderate pedaling rate, increasing the energy by a factor of nearly 10000.

### **Improving Student Success in General Chemistry at CSULB**

Chris Brazier, Stephen Mezyk, Shahab Derakhshan, and Krzysztof Slowinski  
California State University, Long Beach

General Chemistry is considered an essential class for students across the nation who are considering a career involving science, and is one of the California State University system's general education lab science choices. However, for CSULB students passing General Chemistry is often a major challenge! In fact, this class traditionally has such a high failure rate that several years ago the first half of this year-long course, CHEM111A, was targeted to become part of CSULB's Highly Valued Degree Initiative program aimed at improving graduation rates. Now, as part of the CSU's Proven Course Redesign program, CSULB's CHEM111A course is considered a model of success for other CSU campuses to emulate. Through a combined approach of instituting a nationally recognized chemistry placement exam before students could even enroll in the class, major changes in the training of laboratory Teaching Associates, close cooperation with Supplemental Instruction, an increased advising element, and an early warning system where students are notified early in the semester that they are not progressing properly, CSULB general chemistry students in CHEM111A now have an 85 percent pass rate and score well above the national average on the standard American Chemical Society final exam. In addition, the appointment of a permanent course coordinator who developed additional materials for the discussion sections, allowing coordinated and uniform material to be given across all, and having the same mid-term exams ensured each student received equal material coverage and assessment. This same successful approach is now being incorporated into the second half of this General Chemistry course, CHEM111B, starting in Fall 2013. At this time data for the prediction of overall student success based on a pre-assessment exam, and how success correlates with different homework systems being used in this course, are being evaluated. The final analysis of these data, along with the similarities and differences observed between the two halves of this course will be presented.

### **Optimizing a Wirelessly Powered AC-DC Boost Converter for Biomedical Implants**

Marissa Buell, Nehad Dababo, Rene Figueroa, and Peter Moala  
Cañada College

Implanted medical devices (IMDs) have served to increase longevity and quality of life for years. Wireless charging of these IMDs minimizes the required battery size and decreases the need for periodic, invasive surgery. One way to accomplish this is through a Pulse Width Modulated (PWM) AC-DC Boost Converter that uses a simple full-wave rectifier composed of

two diodes and two MOSFETs to convert the voltage from a low AC input to a high DC output. To generate the appropriate PWM signal, a microcontroller measures the frequency of the AC input from a small auxiliary coil parallel to the primary receiver coil. With the orientation of the receiving coil unknown, the optimization of the voltage ratio is imperative to the efficiency of magnetic flux transfer. Previously, motor-controlled rotating magnets were used to deliver power to the implant, which resulted in an optimized output from a duty cycle of 56-62% for the generated sinusoidal waveform. In this experiment, a transmitter coil is used in place of the rotating magnets to generate the AC voltage. Utilizing a transmitter coil allows for high-frequency operation and an adjustable waveform. Through optimization of the duty cycle with a square wave input, a high DC output voltage of 5.12V is generated from a low AC input of 235mV. Using LTspice software and a Printed Circuit Board to illustrate the achieved results, this research aims to prove the increased efficiency from using the paired inductive coils and the optimization of the duty cycle through alteration of the PWM signal.

### **National Science Foundation S-STEM Scholarships: Recruitment and Cohort Establishment for Engineering and Computer Science Students**

Janet Callahan, Amy Moll, Tami Taylor, and Lynn Olson  
Boise State University

This poster describes the implementation and management of two National Science Foundation S-STEM awards at this Metropolitan Campus over the time period from 2006 to 2013. The two awards were designed to be co-managed, and were fully integrated in terms of their implementation. The recruitment and retention strategies deployed resulted in a diverse group of 122 students receiving scholarships. Overall, 15% of recipients were Hispanic (the highest underrepresented minority group in this state) and 25% were female. By comparison, figures at this university are 53% female (2011-2012 basis) and 12% female for this college of engineering. Also during this time frame, the percent underrepresented minority (URM) students, (Alaska native/ Native American/Black/Hispanic/Hawaiian or Pacific Islander) increased from 7.3% (2006) to 11.5% (2013) in the college of engineering, using US citizens and permanent residents as the basis. This slightly exceeds the percent URM at this university, and is roughly at par with the percent of Hispanics in this state. Effective recruitment strategies are described; cohort establishment strategies are outlined and specific examples of programming provided are presented. Ongoing assessment of programming provided was used to help understand how the support could be improved on a year-to-year basis; summative results of these assessments will be presented. The two awards together supported 122 individual students, in six cohort groups. The external support provided by the National Science Foundation was focused on students' first two years of university with transitional support provided by the college of engineering to students for their last few years. The form of this support ranged from placement of interested students in research laboratories for paid positions, other forms of scholarship support, placement into internship positions and more. This material is based upon work supported by the National Science Foundation under grants. Any opinions, findings, and conclusions or recommendations expressed in this material are those of the author(s) and do not necessarily reflect the views of the National Science Foundation.

## **Dynamic Plant Development for Control Systems and Mechatronics Experiments**

Jesús García, Federico Lopez-Casildo Jr., Carl Lewis, Victor Vargas,  
Ozkan Celik, and Nick Rentsch  
Cañada College/ San Francisco State University

The main purpose of this project was to engage community college students in a hands-on experience beyond the classroom and improve engineering curriculum. Our research project entailed mechanical modifications, manufacturing, and testing of haptic paddles that have been revamped by many universities since Stanford University's first design in the mid-90s. The haptic paddle device is a single-degree-of-freedom, force-feedback joystick that is well-suited for both basic and advanced concepts in engineering courses such as system dynamics, mechatronics, control theory, and haptics. We improved the haptic paddle's manufacturability, strength, and we reduced data acquisition system costs. In addition to designing a number of critical haptic paddle components, we have also developed detailed instructions for manufacturing and assembling the device, simplifying its duplication for other engineering departments. The haptic paddle will enable students to physically interact with simulated dynamic systems that can be correlated to the real world, providing them with an enhanced learning experience. We met our goals by making the device affordable, robust, and easy to reproduce.

### **“Engineering Girls – It Takes A Village”: Serving Homeless Middle School Girls via a K-12 Engineering Summer Residential Program**

Lily Gossage  
California State Polytechnic University, Pomona

Poverty is one of the greatest barriers to children succeeding in school. Children from impoverished homes have less access to educational activities and tools during the summer, and in this case, children who are homeless have little to no access. The Consolidated State Performance Report, from the National Center for Homeless Education, showed that more than 220,000 homeless children attended public schools in California in 2011. Motivated by the desire to serve homeless children, the “Engineering Girls – It Takes A Village” program was developed in the Summer 2013. As the newest of the Women-in-Engineering Outreach Programs offered by California State University, Long Beach, this summer residential program was developed specifically to serve homeless school girls. With funding from the California Community College Chancellor's Career Technical Education Pathways Initiative and the California Space Grant Consortium, this unique effort introduced girls and their mothers—who reside at “The Villages at Cabrillo,” a local homeless shelter—to college life and to engineering. For one week, participants resided in the CSULB dormitories and learned about engineering and other STEM disciplines. Considered an untapped youth group for K-12 STEM outreach, the participating students exhibited enthusiasm for math-based majors but reported that they had limited opportunities to such programs. To ensure ample mentoring support, 6 residential assistants and 10 educators also participated in the program. Being able to identify and serve this group of children was the most fulfilling aspect of the program for all who were involved.

## **Stereotype Threat and Social Identity Concerns of African-American, Female Engineering Students: A Grounded Theory Investigation**

Stacie Gregory  
Utah State University

The literature is replete with examples of the contributing role of stereotype threat (STT) to learning and performance decrements for stigmatized students in highly evaluative situations. Much is known about the moderators and mediating processes of STT effects on performance. However, acceptance of STT as more than a laboratory phenomenon necessitates an in-depth, authentic understanding of how stigmatized groups experience being socially devalued and negatively stereotyped. To expand the practical applications of STT interventions, an investigation to clarify the potentially multi-faceted concerns of stigmatized groups, as well as, an identification of the physical and ideological cues that signal STT are required. This study enhances the STT literature using qualitative data to ascertain specific social identity concerns facing African American, female engineering students. The voice of these students offer reliable data that will lead to more impactful intervention strategies to offset the detrimental effects of STT. A promising solution to combat STT is the development and implementation of “identity safe” situational cues including: a critical mass of in-group members, sharing group membership with the instructor, *and* physical cues that create ambiances signifying that one’s identity group belongs. Although identity-safe situational cues are promising intervention strategies, there is an insistent imbalance representation of the social group targeted and an enduring scarcity of *in-group* instructors in engineering classrooms. Therefore, this research lays the foundation for the creation of online modules for engineering courses facilitated by *gender* and *culturally* relevant role models and designed in environments with identity-safe physical cues. Given the current trend in online learning and the increased interest in “flipping the classroom”, such videos, implemented into engineering classrooms across the country, will serve as interventions to increase the retention and persistence of African American, female students in engineering education. Based on the methodology used in this study, further research will allow for implementation of identify-safe cues to protect other underrepresented groups from STT. Data collection and analysis for this investigation follows the cyclical process of grounded theory.

### **Green Energy Project: Gravity Light**

Ryan Harney, Andre Colacio, Anthony Sablan, Nancy Franco,  
Diego Aguilar, Kristiana Cervania, and Tyus Hanson  
California State University, Long Beach

Unreliable access to electrical power is plaguing the development of modern society in third world countries. Utilizing alternative energy sources, this problem can be remedied in even the most remote locations. Our team of freshmen engineers from California State University, Long Beach, has proposed a solution to this issue. We have developed a light source that is powered entirely by the downward force of gravity on a hanging mass. The conversion of a mass’s potential energy to electrical energy can be constructed at any time in any place where gravity is present. Therefore, our light source can be used just about anywhere. In this project, our team

was split up into specialized groups. Our group's specific task was to develop a circuit that converts the energy of a falling mass into energy that could charge a battery, which would power a light bulb. A collaborating team developed a method to convert the kinetic energy of the mass into rotational energy. We have picked up from there and converted the rotational energy into electrical energy to charge a battery to power the light. This energy production technology utilizing the force of gravity has many potential applications even beyond the application of lighting a room. We anticipate its usage in many different and unique devices in the future.

### **Four-Semester Evaluation of Placing Underclassmen in a Senior Level Course as a Retention Strategy**

Harmonie Hawley  
University of Texas at Tyler

In order to attract and retain underclassmen (UN) in undergraduate engineering programs introductory courses are often offered at colleges. The classes most commonly are an introduction to engineering or an introduction to a specific engineering major. Once this class is taken, or if a student is having difficulties in required mathematics courses, the students may not be eligible to participate in another engineering class for some time due to restrictions with prerequisites. At a University in Southern California the prerequisite for a 400-level Environmental Engineering course was lowered to Introduction to Chemistry or Introduction to Biology, thus allowing more students to take the class earlier in their academic career. The 400-level designation indicates a senior level class. A study was conducted over four consecutive semesters to determine if there is a statistical difference in the performance of UN and upperclassmen (UP) in the aforementioned course. In three of the four semesters the final grades for the UP was approximately 1 point (out of a 4-point scale), or 1 letter grade, higher than the UN. In the remaining semester, the UP outperformed the UN but only by about 0.3 points. The standard deviations within the two groups was almost the same for each semester between the two groups and had a value about 1. Analysis of Variance showed that for three of the four semesters there was a statistical difference in the final grades between the UN and the UP at the 95% confidence level. Graduate students and out-of-major undergraduate students who took this class were not included in the statistics. This indicates that even though the same prerequisite was met, the UP were more prepared for the 400-level class. This also indicates that taking this class may not be a good retention strategy for UN as poor performance in lower-level classes may push the students towards another major.

### **Anticipating Student Success by Means of a Simple Math Quiz**

Melinda Holtzman, Donald Duncan, and Branomir Pecjinovic  
Portland State University

It is a common understanding that one of the biggest obstacles to student success in engineering is a lack of adequate math skills. Some current research indicates this might be the biggest obstacle of all. For example, a study on the effectiveness of expanding freshman introduction classes found the expanded classes useful – unless the students lacked adequate math

preparation, in which case they had a high rate of failure regardless of the freshman class [Vergun]. In this work, we describe an attempt to flag electrical engineering students with poor math skills by means of a short quiz given at the start of their sophomore circuit analysis class. The quiz was given at the beginning of this past fall term, and results compared to two midterm exams. Comparison with final exams is not yet complete at the time of this submission. Analysis indicates that there is not a correlation between a specific grade on the math quiz and specific grade on the midterms; e.g., students who got an A on the quiz did not necessarily get an A on their midterms. However, there is a strong correlation between the broad categories of passing or failing the math quiz (defined as  $>$  or  $<$  70%, respectively) and passing or failing the midterms. This indicates that flagging those students who do very poorly on the math quiz could well be a way to identify those students who will later have trouble in their engineering courses. The hope is that guiding those students into math tutoring at that early point could be a more effective and proactive intervention than waiting till students are struggling in their engineering classes.

### **Gyroscopic Cup Holder**

William Hovik

California State University, Long Beach

Gyroscopes have been used in many different applications such as airplanes, space equipment, and two wheeled automobiles in order to stabilize and measure orientation. Gyroscopic technologies could be an excellent improvement to modern luxury vehicles. A gyroscopic cup holder in a vehicle could be used to prevent unwanted stains from beverages caused by an unstable ride. The cup holder will be mounted with freedom in all three axes to allow for counteractive movement. The cup holder could be designed in two different ways: one using more of a mechanical approach and the other using a more electronic approach. To go about it mechanically, the cup holder will have a small flywheel attached to the bottom powered by an electric motor. The generation of angular momentum caused by the flywheel will create a force strong enough to maintain the cup's vertical orientation despite sharp turns and variable positions of the vehicle. The more electronic design will involve a vibrating structure gyroscope or "Coriolis Vibratory Gyroscope" (CVG). A CVG is a term for a wide group of gyroscopes using solid-state resonators. An inexpensive CVG manufactured with Microelectromechanical Systems (MEMS) technology can be used to accurately detect and correct any movement that would move the cup out of its vertical orientation. A system of small electronic actuators can be used to adjust the cup's orientation according to the signal of the CVG. Both these systems offer secure stability for the beverage being placed within the cup holder, reducing the chance of spillage. The cup holder will be mounted to optimize movement and placement within the automobile. Simple innovations such as this contribute to the overall quality feeling of the luxury car experience.

## **Exposing Students to State-of-the-Art in Unmanned Vehicles Technologies**

Kevin La, Subodh Bhandari, Zekeriya Aliyazicioglu, Scott Boskovich, and Daisy Tang  
California State Polytechnic University, Pomona

Unmanned Aerial Vehicles (UAV's) and Unmanned Ground Vehicles (UGV's) are assuming greater roles in civilian and military applications. They are simpler, cheaper, and pose no threat to human operators. UAV's have potential of replacing manned aircraft for dirty, dull, and dangerous missions. For both vehicles to be of greater value to complex missions and for cost effective operations for applications such as Search and Rescue, Intelligence, Surveillance, & Reconnaissance, Agricultural Applications, UAV's and UGVs must be able to coordinate their actions with each other and utilize their capabilities. UAV's are one of the fastest growing sectors of the aerospace industry. However, there is a lack of professionals entering the workforce for UAV related jobs. The ongoing projects at Cal Poly Pomona are designed to increase students' interest, by means of hands-on learning, and expose them to state-of-the-art in unmanned vehicles technologies. This will be helpful in preparing a strong workforce for future needs of aerospace industry, which is facing an aging workforce and there is a need for a well-trained workforce that is ready to take a higher level of responsibility than entry level graduates usually do. This poster is about the Northrop Grumman funded project titled "Investigation into Operations with Unmanned Vehicles" that involves more than 70 students, both undergraduate and graduate, from six different departments in the Colleges of Engineering, Science, and Business. The project is a collaboration between Cal Poly Pomona and Cal Poly San Luis Obispo. One of the goals of the Northrop Grumman funding is to provide an opportunity for students from two campuses to engage in a multidisciplinary research and collaborate with teams that are geographically dispersed, thus providing the students with real-life experience. As such, the projects related to unmanned aerial and ground vehicles require expertise from several disciplines including Aerospace, Electrical & Electronics, Computer, Mechanical Engineering and Computer Science.

## **Design and Testing of an Engaging Submersible Robot for Remote Exploration of the Cabrillo Marine Aquarium and Surrounding Marine Environment**

Samuel Landsberger, Ye Ding, Garrick Gregory, Nathyaeli Parada, and Rodrigo Villalta  
California State University, Los Angeles

*Goal:* Undergraduate and graduate students are developing an underwater robot with both camera and environmental sensor suite to provide an engaging and highly accessible exhibit for the Cabrillo Marine Aquarium (CMA) in San Pedro, CA. The robotic explorer, building upon two earlier generations of marine explorers created by the lab, will be enjoyable, stimulating and educational for visitors both young and adult. Children of all ages will be able to control the robot's speed and camera view along a track or cable, both onsite from within the Aquarium and offsite via a web interface using the internet. The Cabrillo Aquarium is a wonderful, low-budget operation with a dedicated staff of scientists that welcomes the chance to have an engaging, high-tech and interactive display that is available not only to the visiting public, but worldwide via the



web. CMA believes that visitors will be sparked by the robotic explorer in addition to the marine environment displayed. Such a low-cost but accessible and powerful addition to an institution such as CMA does not currently exist. *Outreach:* Students will additionally engage with K-12 students in at-risk communities surrounding the campus to bring them to the CMA and engage them in the challenges and excitement of the marine engineering design process. *Future:* A longer-range goal is to enable remote observation and monitoring of the surrounding marine ecology of Cabrillo Beach, including the unique Grunion Runs and sensing/recording of tides, pH-levels, dissolved oxygen, temperature, and perhaps pollution monitors developed by researchers (e.g., heavy metals or DDT). The students aim to provide CMA staff and researchers with a scientific and viewing platform that is modular, flexible in configuration, and both easy to operate and to interface with for data gathering. It is anticipated that future student and researcher teams might develop manipulator arms, sediment and water column sampling systems to both perform in-situ experiments and gather data over extended timeframes.

### **Specification of Performance Criteria for Assessment of Student Outcomes**

Mary Lee, Anne-Louise Radimsky, and Cui Zhang  
California State University, Sacramento

The Department has identified nine outcomes, (a) through (i), (macro level) that students are expected to possess at the time of graduation. To effectively assess outcomes, 34 measurable performance criteria (micro level) were specified by faculty to assess core topics in upper division required courses. These criteria, updated and refined over the past several years, link student outcomes with upper level core courses. Outcomes (a) through (d) address theoretical concepts, technical knowledge, and skills necessary for graduates to be successful upon graduation. Performance criteria associated with these outcomes are evaluated using course assignments and test-embedded questions. Outcomes (e) through (i) address non-technical characteristics or abilities graduates are expected to possess, such as, effective communication skills, oral and written; understanding of ethical and legal issues, etc.; and ability to contribute as a team member. Criteria for these outcomes are evaluated by reviewing senior project reports and presentations, student reflections, and employer input. Because all performance criteria are well integrated in regular faculty evaluation of student performance, we have found that assessment does not require significant additional effort on the part of faculty. In a three-year cycle, all outcomes are assessed and areas of deficiency are clearly identified. This method of specifying and assessing performance criteria for student outcomes has enabled the Department to implement its assessment in a systematic and organized manner.

### **Teaching Digital Signal Processing through Music**

Jack Ou and Farid Farahmand  
Sonoma State University

We describe in this poster our experiences gained from teaching a junior-level course in digital signal processing which was made possible through a grant we received from Green Music Center, a newly constructed concert hall at Sonoma State. In most universities, Digital Signal

Processing (DSP) is a junior-level course for which a traditional background in linear systems is assumed. Even though students enrolled in DSP are expected to have achieved some level of competence in concepts covered in linear systems, in practice, many DSP students continue to struggle with pre-requisite with concepts covered in linear systems. Our primary challenge in teaching this course is to introduce important concepts in DSP while keeping students engaged. In this poster we provide extensive details so others can learn from our experiences. We describe our preparation prior to the beginning of the course to help us get ready to teach this course. We discuss our selection of textbook used in this course, our use of examples drawn from fields of audio signal processing, image processing, and biomedical signal processing, our uses of multimedia resources to help students visualize complicated operations such as sampling, aliasing and filtering in the frequency domain. We describe the hardware experiments we developed and revised in collaboration with a student assistant to help other students gain direct reinforcement from hearing the effects of filtering operations implemented on a DSP board. We provide student survey results to document our successes as well as shortcomings in teaching this course. Results such as students' feedback on the textbook, hardware experiments, multimedia resources, progression of concepts, overall satisfaction of the course are provided so that others can learn from our experiences. We believe that our experiences described this paper are useful for instructors who are interested in exploring alternative pedagogies in teaching digital signal processing.

### **Expanding Multi-institutional Bonds to Team up Students for the Creation of Research Environmental Projects**

Mónica Palomo, Ali Sharbat, and Russell Di Fiori

California State Polytechnic University, Pomona/ Pasadena City College

The purpose of the project is the bridging of Cal Poly Pomona (CPP) Civil/Environmental Engineering students and Pasadena City College (PCC) Science students to enhance the curriculum at both institutions, while enhancing retention of both CPP and PCC of students and facilitating PCC student transfer to CPP; and promoting graduate school and lifelong learning in a multidisciplinary and in a diverse environment. The project combines the training of CPP undergraduate students (without previous research experience) and their partnership with PCC students to develop multidisciplinary teams that worked on the design of natural treatment systems to remediate contaminated surface water streams. Twelve (12) Cal Poly Pomona engineering students were trained on how to conduct research and partnered with 50 Pasadena City College students. Students from both institutions were mentored by CPP and PCC faculty while conducting research. In addition, each institution had a senior student mentor assigned to the student groups to enhance peer-learning process. Student mentors provided support to students while conducting experimental work in the lab, with data analysis and while preparing posters and required research reports. To develop the research experience two courses were offered concurrently one at CPP and the other at PCC. Faculty in both institutions worked on developing student interaction through fieldtrips and social media. The project platform allows sustained collaboration, among engineers and non-engineering students and faculty thought a novel approach. The proposed study provides feedback of the effectiveness of the proposed approach to achieve the use of undergraduate research activities to create bonds between the two institutions.

## **Augmented Reality for Visualization and Feature Identification of Solid Models in Engineering Graphics**

Ananda Paudel  
Colorado State University, Pueblo

One of the major objectives of engineering graphics course is to familiarize students with 3D visualization and 2D projections. Visualization of an object's shape in 3D is a challenge for many engineering students. Traditionally, engineering drawing is taught with pencil and paper, and asks students to imagine and visualize the 3D shape of the object from 2D. It is difficult to explain 3D geometry using drawings on paper or on the screen, and students struggle to comprehend undergoing geometric transformations from 3D to 2D and vice versa. Different software are developed to create 3D objects that help in visualization, but it is still difficult for the beginner to understand the projected shape of 3D into 2D. Explaining with a physical model is a better way to deal with this problem. However, students have a greater attraction towards computer models than physical objects. This paper presents a study of use of Augmented Reality (AR) to help computer passionate students to visualize the object shape as well as to identify the different geometric and engineering features of a solid model. The AR system displays virtual information in a person's physical environment so that the person will perceive that information as existing in their surroundings and be able to manipulate the orientation of the object. It aims to integrate the real world and the artificial environment. Recently it gained popularity because of the possibility of being implemented on smart phones. AR consists of a video device, mobile or computer, a markup sheet and virtual models. The AR system displays 3D geometry of models as a real-time video and the model can dynamically move around in real-time as a real object on the mark up sheet. This study compares the learning effectiveness of three different visualization techniques: paper drawing, AR models, and physical objects. To verify the effectiveness a survey was conducted in an engineering graphics class of 40 students.

### **Modeling and Implementation of Brain-Inspired Neural Network for Edge Detection and Object Recognition**

Hamid Mahmoodi, Hector Prado-Guerrero, Norman Ettetdgui, Arash Koushkebaghi, Rita Melgar, Maral Amir, Cheng Chen, Amelito Enriquez, Hao Jiang, Wenshen Pong, and Hamid Shahnasser  
San Francisco State University/ Cañada College

As technology advances, hardware neural network models become more viable and desirable due to their parallel nature. However, the use of hardware limits its capabilities because component resources are quickly depleted. To solve this problem we used software instead and implemented a neural network model to process orientation detection using C++. Biologically, light enters the eye and travels through several layers of neural cells responsible for edge detection. Our software setup simulates this process by collecting data from a webcam (eye/photoreceptors) and then passing this data to a two dimensional array. This array is scanned and transformed to a smaller array (ganglion cells) to be scanned for several angles (simple cells) and finally passed into different linear arrays. These linear arrays hold the total values of each line in a specific orientation and then these values are summed and expressed as a final degree of confidence for

each supported angle (complex cell). There are several advantages of working with software such as the ability to modify code and spread capabilities at a low costs. Furthermore, multiple threading can be used to simulate the parallel tasking performed by the brain which was the main advantage to the hardware approach. In developing our model, an initial concern was whether the sequential processing will compromise the performance of the fast parallel processing hardware model. As it turns out, performance was not an issue. Not only were we able to do the same process as the hardware approach but we were able to surpass the dimensions of the frame that was being processed. After numerous hours of testing and debugging, a brain-inspired neural network for object recognition and edge detection was successfully modeled. While processing a 640X480 pixel frame at 30 FPS, we were able to detect 0, 45, 90, and 135 degrees. Alongside a successful model, we have created a framework for further expansion and research.

### **An Organizational Model to Manage the Assessment Process for ABET**

Amir Rezaei and Parham Piroozan  
California State Polytechnic University, Pomona

This poster describes an organizational model that shows the assessment process for an engineering department that is preparing for an ABET visit. The process is a dynamic and user-friendly model that clearly demonstrates our assessment model. The process was developed to meet the following goals. First, it needed to be easy to understand by all of our constituents. Second, it needed to be a continuous process that ensures the assessment of all program outcomes over a reasonable length of time. Third, it needed to be easily incorporated within the existing operations of the department and the activities of individual faculty in the assessment process. Finally, it needed to be sufficient to satisfy the ABET requirements for assessment, as well as those for the college of engineering and the university. This organization is a useful tool that fulfills the new ABET criteria 4 which is called “Continuous Improvement.”

### **The Integration of the *Promotores* Model and the Cultural Capital Model to Catalyze Latino Educational Success in Engineering**

Britt Rios-Ellis, Mayra Rascon, Gino Galvez, Natalia Gatdula, and Maria Ramirez  
California State University, Long Beach

California State University Long Beach (CSULB), the flagship university of the CSU system, was designated as a Hispanic Serving Institution (HSI) by the U.S. Department of Education (USDE) in 2005. According to the U.S. Commission on Civil Rights, Latino students are gravely underrepresented in the Science, Technology, Engineering and Mathematics (STEM) fields (2010). In 2011, CSULB received a grant from the USDE to create initiatives that foster educational success within STEM. With less than 3% Latino tenure-track faculty among the more than 200 faculty members in both colleges, first generation-educated Hispanic students in the STEM fields have few role models to emulate. To increase and reinforce a trend of Latino educational excellence, the Center for Latino Community Health, Evaluation, and Leadership Training (NCLR/CSULB Center) in collaboration with the Colleges of Engineering (COE) and Natural Science and Mathematics (CNSM), aims to promote minority student success by providing culturally relevant academic support to underserved Latino students through the

*Promotores de STEM* (PES) component. PES was designed to provide high achieving first generation-educated Latino students with on-campus training and employment to mentor, tutor, and link underserved and low achieving Latino peers to needed campus services. Although PES mentors are divided among CNSM and COE, over 50% of mentors reside in engineering. PES creates the opportunity for a first generation-educated Latinos to be mentored by high achieving peers who have experienced similar contextual barriers and facilitators to academic success. It also increases recognition of the *promotores* among their peers, faculty and staff, which serves to change campus perception regarding Latino students' potential for high academic achievement. The Latino Health Communications Model, which catalyzes cultural attributes to potentiate positive behavior, was fused with Yosso's (2008) Cultural Capital Model to create a Latino Cultural Capital Model that is utilized by the NCLR/CSULB Center.

### **ENGR102 Project: Assisting Freshmen Engineering Students to Validate their Choice of Major or Consider Other Options Based on their Interests and Abilities**

Jina Flores, Erin Booth-Caro, Peggy Murphy-Hayden, and Terri Armstrong  
California State University, Long Beach

The Career Development Center at California State University, Long Beach designed and implemented an extensive program entitled The Engineering 102 Project during the spring 2013 semester. The goal of the project was to assist students, mostly comprised of freshmen, in identifying their interests to validate their selection of an engineering discipline or consider other options. By discussing these options and presenting important decision-making components such as the balance between interests, values and abilities early in their studies, the Career Center sought to empower the students to make sound decisions regarding their major and career. The project was timely in that while the United States has seen improvements in engineering graduation rates, statistics nonetheless show that approximately 40 to 50 percent of engineering students will change out of the major. The Career Center worked collaboratively with The College of Engineering to deliver the program and collect the much needed data to measure student learning outcomes. A total of 447 students enrolled in Engineering 102 completed the Strong Interest Inventory in class. One week later, career counselors visited all 13 sections to distribute individual hardcopy results and explain the relevant personality theory developed by John Holland. To further support students in their career exploration, they received results via email which included clickable links to resources such as O\*Net Online database of occupational information. Throughout the process, data was collected through pre and post assessments as well as group interviews of 68 students. The semester long project provided important insight into freshmen engineering students. Most notably, many students were optimistic regarding their mathematics aptitude, sometimes unrealistically so, and they felt affirmed in their major selection as a result of their interest inventory. During the group interviews, many students expressed readiness to begin core engineering classes to test their abilities. They also wanted to hear directly from experienced engineers about work roles in order to help them decide if the engineering career path was right for them.

## Utilizing Steel Plate Shear Walls for Seismic Hazard Mitigation

Agustin Robles, David Alvarez, Jasmine Flores, Cham Htun, James Enright, and Cheng Chen  
Cañada College/ San Francisco State University

In a ten-week summer research internship program, sophomore civil engineering community college students have the opportunity to design the lateral force resisting system of a three-story building located in the earthquake-prone San Francisco Bay Area. The designers shall utilize steel plate shear walls as the lateral force resisting system of the structure. The objective of this research is to understand how to implement current seismic technologies into designing a cost-efficient and environmentally friendly building. The use of structural engineering design specifications and seismic provisions such as ASCE 7-10 (American Society of Civil Engineering) and AISC 341-10 (American Institute of Steel Construction) promotes early exposure to the governing building codes used in professional practice. Computer programs such as Excel and MathCAD are used to design the innovative lateral force resisting components to optimize the structure's performance. SAP2000 (Structural Analysis Program) is used to simulate and evaluate the response of the designed structure to selected ground motions from past earthquakes acquired from the USGS Pacific Earthquake Engineering Research Center. This research internship program allows for the development of project management, time management and teamwork skills, all of which help strengthen students' knowledge of seismic design in Civil Engineering and prepare students for successful academic and professional careers.

## Using the SELECT Format in an Introductory Engineering Course

Phillip Rosenkrantz  
California State Polytechnic University, Pomona

The Industrial and Manufacturing Engineering (IME) Department admits new students from varied academic backgrounds. Approximately 30% are first-time-freshmen (FTF). The rest are approximately split between transfer students (TR) and change-of-major students (COM). Many of the TR and COM students have senior standing because of the number of college units taken prior to and after entering the department. FTF students can take EGR 100/L The Engineer and Society, which is a typical *first year experience* course for freshmen only. EGR 100/L is not discipline specific and satisfies General Education requirement Area E. Besides EGR 100/L, each engineering department offers some sort of introductory course that usually includes content about engineering communications and topics from the discipline. Based on assessment results and concerns about student readiness at all levels, six years ago the IME Department converted a topic-oriented 3 unit introductory course into a course that incorporates many features of a first-year experience course. The design was adapted for the inclusion of transfer students and even seniors who were changing majors. The word SELECT spells out the objectives for the course. SELECT stands for:

- Study skills, time management, eliminating time killers
- Ethics/Academic Integrity (decision making)
- Lean (improve flow, eliminate waste)
- Engagement (in the department and major)

Communications (written, oral, interpersonal)

Teamwork (High Performance Team Model)

Students are told: “*You SELECT what you do with your time and your life...this is personal leadership. SELECT is a roadmap for academic, organizational, and career success.*”

Assessment and other data have been kept on several aspects of the course: Improvement in study skills, impact of time wasters on study time, and student teamwork and leadership. On the time waster assignment added in Fall 2012, 31% of the students were able to make significant progress in eliminating or mitigating a major time-waster in their lives.

### **Using Inquiry Based Learning Activities to Teach Dynamics**

Baheej Saoud, Brian Self, and James Widmann  
California Polytechnic State University, San Luis Obispo

Dynamics is a fundamental discipline in many engineering degrees that students often struggle to learn and master. The basic concepts such as Newton’s Second Law, friction, and rolling, are not only difficult to understand, but can also be difficult to teach effectively in a normal lecture format. The Dynamics Research Team at Cal Poly SLO aims to find ways to engage and help students understand and retain basic dynamics concepts throughout their educational and professional careers. The team has developed a set of four Inquiry-Based Learning Activities (IBLAs) that bring the problems students see in their text books into the physical realm to aid in their understanding of the underlying dynamics concepts. The IBLAs are formatted such that a simple system, such as a spool and thread, is presented to a group of three to four students who are then asked to predict the behavior of the system based on their understanding of dynamics concepts. They can then experiment with that system with actual spools to see if their predictions were correct. Finally, the professor can explain the underlying concepts in the context of a tangible example of those concepts at work. The success of the IBLAs are validated using the Dynamics Concept Inventory (DCI), a test taken at the beginning and end of the term that helps to track student learning, as well as through individual talk-alouds, where students are taken out of the group context of the IBLA and talk through their thought process to discover common misconceptions about dynamics concepts the IBLAs are aimed to address. By the end of the talk-aloud, the team has seen that in most cases, the student can answer a transfer question correctly and give a satisfying explanation of their answer to show they understand the concepts. The results of the DCI show noticeable improvement in three of the four IBLA concepts whereas the spool IBLA shows little improvement.

### **Using Algorithms to Enhance Comprehension of Concepts in Introductory Chemistry Courses**

S.R. Subramanya and Jaqueline Ruiz  
National University

At National University, most students are adult learners, returning to college after a few years of break since graduating from high schools. This hinders many of these students from understanding the rational thinking behind interpreting equations and formulas, and grasping

several simple concepts. Typical examples of concepts which are routinely used in introductory general chemistry classes include: (a) direct or inverse relationships; (b) balancing chemical equations; (c) relationships between the numbers of atoms and molecules represented in chemical equations and the actual weights/volumes of elements and compounds involved in chemical reactions. In this paper, we present the use of well-designed algorithms specifically designed for the categories of exercises/problems required to be solved by the students in introductory chemistry classes. The algorithms that we have designed come in two broad flavors – (a) well-defined sequence of written steps to guide students rational thinking and (b) simple hands-on, specifically-designed gadgetry that the students ‘play’ with to solve the exercise/problem at hand. These facilitate the breaking up of the processes of chemical reactions, unit conversions, etc., into well-defined steps which are easy for the students to grasp, practice, and ultimately have a good understanding.

### **Effect of Climate Change on the Critical Elevation Zones in a Snow Dominated Mountainous Watershed in the Sierra Nevada, CA**

Rebeka Sultana

California State University, Long Beach

Snowmelt water makes up about 30% of California’s water supply. Amount of winter precipitation and variations in spring temperature coupled with elevation gradients affect the snowmelt distribution which controls the magnitude and timing of peak streamflow. A critical elevation zones defined as fraction of watershed area that dominates the most of the snowmelt can change with climate change. Shift of critical elevation zones due to climate change is studied at the Upper Merced Basin located at the south of Sierra Nevada mountain. Hydrologic response at the watershed is simulated using Soil and Water Assessment Tool (SWAT) model. The watershed area is 5252.8 km<sup>2</sup> and is highly varied in elevation (17 m to 3979 m) where most of the land cover is dominated by forest areas. More than 70% of the rainfall becomes snowfall which becomes streamflow at the end of the snow season. The model was run with daily station based precipitation and temperature data for the period of 2003 to 2011. SWAT model parameters was autocalibrated using Sequential Uncertainty Fitting (ver 2) scheme in SWAT-CUP model for 2003 to 2007 and validated for 2008 to 2011 at the two stream gauge station, Happy Isles and Pohono. The calibrated model has R<sup>2</sup> value of 0.67, and 0.65 for calibration and validation period. Thirty one future climate scenarios were created by perturbing the past 30 year’s station minimum, maximum temperature and precipitation data. Results show that minimum or maximum temperature change of +1° to +2° have trivial effect on the peak streamflow at the high elevated areas but the response is more significant at the low elevated lands by changing timing of streamflow. Increase/decrease in precipitation changes the streamflow volume at both the upper elevated stream gauging stations and watershed outlet. However, critical elevation zones did not have significant change.



## **Modeling Civil Engineering Practice in Student Activities**

Fariborz Tehrani, Jessica Regier, and Kelsey Hoffman  
California State University, Fresno

The student chapter of American Society of Civil Engineers (ASCE) in California State University, Fresno, hosts the 2014 Mid-Pacific Conference. This event is an opportunity for civil engineering students to demonstrate their technical and leadership skills by participating in various competitions. General activities of the student chapter involve design and management tasks to develop teams, plan projects, design and construct products, and deliver or present the output during the event. In addition, a new student organization, ASCE Mid-PAC, has taken the lead to organize the 2014 event. Roles and responsibilities of this group rise above general duties of an ASCE student chapter to serve a larger body of students and professionals from multiple schools, including three international groups. This paper presents learning opportunities for students by aligning ASCE Mid-PAC activities with component of civil engineering practice, including professionalism, leadership, and ethics. These components represent ASCE Body of Knowledge (BOK) as well as accreditation measures by the Accreditation Board for Engineering and Technology (ABET). An independent study course formalizes the learning process and serves as a platform to assess the outcomes. The main focus of this process is the transition from student to professional engineer. This transition is facilitated by learning fundamentals of leadership, ethics, business, and public policy in conventional classroom. However, the ASCE Mid-PAC organization is an excellent opportunity to allow students to demonstrate their abilities and implement them in an on-going project with regional, nation and international impact. Further, student advising sessions supplements the learning process by providing necessary theoretical and knowledge-based modules in leadership, communications, and other relevant topics. Finally, the Student Outcome Assessment Plan (SOAP) provides measures to assess the outcome of this process in comparison with conventional classroom experiences. The success of this model will encourage incorporation of student organization activities in civil engineering education.

## **Integrating STEM into K-6 Teacher Education: A Multi-Disciplinary Approach to Faculty Collaboration**

Fariborz Tehrani, Fredrick Nelson, Nell Papavasiliou, Carol Bohlin, and Mara Brady  
California State University, Fresno

With the adoption of the *Next Generation Science Standards* (NGSS), science instruction in elementary classrooms is poised for dramatic change. Science content has been reorganized into three dimensions: Science and Engineering Practices, Crosscutting Concepts, and Disciplinary Core Ideas. For the first time, engineering is explicitly included, not only as part of the practices, but also as a specific set of disciplinary core ideas focusing on design and linkages among engineering, technology, science, and society. Learner performance expectations in the

standards integrate key ideas from the three dimensions, resulting in learners acquiring and applying knowledge and thinking and reasoning scientifically. This approach necessitates learners' engaging actively and directly in the practices of science and engineering in order to construct scientific understanding. To meet this need we have designed a cross-disciplinary, 12-semester-unit (4-course) Science, Technology, Engineering, and Mathematics (STEM) Concentration in Liberal Studies. Liberal Studies majors typically enter the credential program for elementary teaching, but interest from this group of students in science courses beyond what is required has been limited. The STEM Concentration affords a transformative learning experience for future elementary teachers through deliberately designed integrative courses with these shared purposes: (a) increase interest in and generate excitement for teaching and learning about science, technology, engineering, and mathematics; (b) provide coherent and connected STEM learning opportunities; (c) model research-based and inquiry-oriented STEM pedagogy; and (d) facilitate awareness of the *Science and Engineering Practices*, *Crosscutting Concepts*, and *Disciplinary Core Ideas* of the *Next Generation Science Standards*. In this poster, we will share our approach to the design of these connected courses and our plan for multidisciplinary faculty collaboration and professional development. We will show how we have used the *Crosscutting Concepts* as a theme for the explicit integration of content across these courses, and discuss our success and challenges with the program to date.

### **Drones for Personal and Commercial Use: Implementing a New Design with Zero Emissions**

Carlos Vergera, Juan Viana, and Florian Pal  
California State University

As our society evolves to a more complex and fast paced system we must look for ways to complete simple tasks faster and with less consumption of time. Our idea was conceived after hearing news that our world is starting to implement unmanned aircraft for commercial purposes. Our idea and goal is to develop a design and a working prototype of an emission-free unmanned vehicle that is cost effective and operable autonomously or via remote control. The design will be emission free due to the implementation photovoltaic cells on the body of this new design. We will be focusing on the development of a simple and inexpensive design that is also versatile and can complete many different tasks with just a few simple modifications that any person can complete. This design can be mass produced and available to the public for personal use. Our research shows that we can make this technology available to almost any household by having a maximum price range of around \$500 per vehicle. The drones can be used for many personal tasks ranging from plant watering to surveillance to clean up and even structure analysis. The availability of this technology to the common household can make the lives of everyday people so much easier and less stressful. Our target market are middle class households in need of an additional entity to complete simple tasks that one is otherwise too busy to complete to simply ignores due to lack of attention. However, we plan to incorporate this idea to larger scales by implementing this cost efficient technology in every possible sector; manufacturing, local deliveries, search and rescue, landscape modeling, land surveillance, property protection, and even law enforcement. There are many ways this technology can be implemented which is why we seek to make this technology available to everyone by making it simple, inexpensive, and ecofriendly.

## **Inspiring the Next Generation of Female Scientists and Engineers**

Kim-Phuong Vu, Lily Gossage, Panadda Marayong, and Thomas Strybel  
California State University, Long Beach

The Engineering Girls Summer Internship is a summer residential program for 8<sup>th</sup> grade girls funded by the Center for Human Factors in Advanced Aeronautics Technologies at California State University Long Beach. It was designed for 8<sup>th</sup> grade female students who are academically-advanced in mathematics/science and show potential and interest in learning about engineering and technology. The program consists of Lab-based workshops on various disciplines of engineering, including human factors, and field trips to expose the girls to engineering in real-world contexts. This program reflects a productive collaboration between the College of Liberal Arts (Vu & Strybel) and College of Engineering (Marayong & Gossage). In this presentation, we provide an analysis of the interns responses to pre- and post-program surveys. Data from three cohorts of girls in the program will be presented to demonstrate the potential benefit of our programs in achieving the goal of inspiring the next generation of scientists and engineers. By providing early outreach to high-achieving young women and acknowledging their potential to their parents and K-12 educators, we hope to break the traditional barriers that will prevent these young women from entering STEM disciplines.

## **Using Videos to Enhance Engineering Instruction**

Nancy Warter-Perez and Jianyu Dong  
California State University, Los Angeles

Videos can be an effective tool for enhancing engineering instruction. They can be used solely in place of formal classroom instruction in a flipped classroom or they can be used selectively to provide some content outside of class creating more time in class for active learning and/or a more in-depth coverage of a given topic. Videos can also be used for tutorials for teaching laboratory methods and tools, demonstrations, solving example problems, and homework solutions. Videos have the advantage that they can be stopped, rewound, and replayed whenever a student needs to review a particularly difficult or complex concept. Over the past several years, we have been experimenting with using videos to enhance instruction in a variety of computer engineering courses at California State University, Los Angeles. Our goal is not to flip the class entirely, but rather to use videos to enhance learning. In this poster we will present an array of strategies that have been used for integrating videos into one lower division and three upper division computer engineering courses (digital engineering, microcomputer programming, computer organization, and multi-media networking), at California State University, Los Angeles. We will present some preliminary survey data on what types of videos students find beneficial. We will also discuss a variety of methods for creating and sharing videos with students. Based on our experience to date, we will share best practices in video production in terms of video length, organization, and content delivery.

## **Faculty Participation in a Learning Community Improves STEM Student Success**

Kelly Young, Jen Mei Chang, Jesse Dillon, and Laura Kingsford  
California State University, Long Beach

STEM educators must have the tools and support to effect change in their teaching in order to provide students with innovative and effective learning environments. However, STEM educators receive relatively little formal training in teaching, in particular how to evaluate student learning, and translate that into effective changes to classroom practices. The College of Natural Sciences and Mathematics (CNSM) at California State University Long Beach (CSULB) is currently undertaking a cross-discipline, STEM-specific faculty development project to empower STEM faculty to engage in active and effective pedagogical practices. We hypothesized that bringing together faculty for a two semester Faculty Learning Community (FLC), consisting of one semester of facilitated online learning and discussion followed by a second semester where proposed changes were implemented, would result in enhanced learning outcomes across a variety of STEM courses. To create the FLC, STEM-specific resources were culled from a variety of resources and organized around five discussion topics: Students Today, Student Engagement, Active Learning, Team-Based Learning, and Assessment. During the first semester, CNSM faculty members were asked to research pedagogical literature, identify new pedagogies of engagement, and discuss ideas and concerns with FLC peers while completing guided online learning modules. During the second semester, FLC participants incorporated teaching reforms, evaluated the impact of those changes on student learning, grades, and retention, and reported their findings. To best appeal to the working scientists and mathematicians that make up the faculty of the CNSM, FLC participants were encouraged to form hypotheses about the potential effect of the change, design the implementations as an experiment using “control” and “experimental” groups, analyze their data, and reflect on results as they would any experimental data set. FLC participants reported that the ideas presented in the online learning module were practical and applicable to their courses; many participants reported improved student responsiveness following feasible pedagogical change, and direct impact on student achievement. Other FLC participants reported positive gains in student responsiveness and engagement in difficult STEM courses.

## **Training Mathletes Using Countdown Method**

Ziliang Zhou  
California Baptist University

This paper shares the experience of using the Countdown method to train middle school students for MATHCOUNTS competition. Similar to the flipped classroom concept, the author turned the Countdown round competition, a traditionally (unofficial in most states) fun round competition after the written round competition, into an active tool of math training. This particular approach has two immediate results: (1) the students were more motivated to participate and to learn math; and (2) the fast paced Countdown method training enhanced

students' fast thinking problem solving skills, a key feature of the MATHCOUNTS competition. To turn the Countdown round into an effective math learning tool, the author made several adjustments and enhancements. These include using a giant TV screen for better viewing, established an automatic timer, and developed a couple of different tools for students to signal that they got the answers. In addition, the Countdown method training was conducted as a group competition as well as individual event. For the last 5 years, partially due to this effective approach, there was a steady increasing participation in MATHCOUNTS competition in local middle schools. In the meantime, there has been improved performance among students who went through the Countdown method training comparing with students who did not go through such training at local MATHCOUNTS competition. The author also shared the difficulties in using such training method in learning math and suggested ways of improvement. In the long run, the author intends to expand such training method into other areas of learning, especially in the area where competition among students becomes a major motivation factor. The author also intends to explore the possibility of expanding such training method to a much bigger student population and to make math learning a fun and effective process.

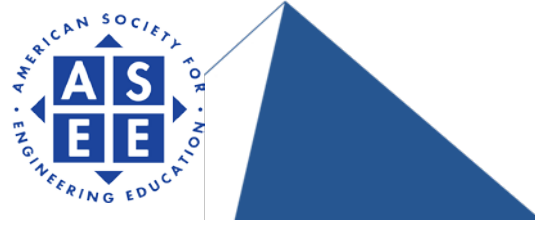

**April 24 – 26, 2014 | Long Beach, California**  
ASEE Zone IV: Pacific Northwest, Pacific Southwest, and Rocky Mountain

# WORKSHOP ABSTRACTS

**“Jack of All Trades, Master of None” – The Challenge for Future Oriented,  
Interdisciplinary Curriculum Programs**

Christiane Beyer, David Teubner, and Howard Fletcher  
California State University, Long Beach

A competitive environment characterizes product Design and Development processes. Innovation, quality and price of a product determine its success or lack of success. To meet market and customer expectations, companies need to work in interdisciplinary teams to bring together skills of different disciplines. However, the challenge for educational degree programs is to design majors that prepare the students for their careers and arm them with the necessary academic and professional skills. In addition to specific knowledge in various academic and practical settings, intellectual tools and project-based approaches are needed to build bridges across academic disciplines and to apply their skills. Team skills are as important as critical thinking, writing and presentation skills. A basic understanding cross-disciplinary boundaries is necessary for an end-to-end-development process. The paper describes a work-in-progress analysis of how different initiatives at CSULB challenge their students to be ready for real-world applications. Included in the analysis are case studies on hand-on senior design projects where Mechanical Engineering students collaborate with Industrial Design students to develop design innovative products. In addition, there is the CSULB Innovation Challenge, a collaboration between College of Engineering and College of Business Administration, which provides a platform for students to ignite their imagination and creativity while considering the needs of society and commercial viability of their innovations. In the offered classes and programs, experienced faculty advise students with modern tools and methods for product design and development and teach them the significance of time and financial budget. The cornerstone of the program is a capstone project in which interdisciplinary student teams conceive, design, and manufacture real-world products. The projects focus on functionality, ergonomic and esthetic aspects as well as commercialization issues involving market size, competition, finance etc. The instructors are faced with the challenge of coordinating interdisciplinary tasks in order to achieve a common objective. These objectives include the awareness of different disciplines like marketing, finance, industrial design, engineering, and production in the development of new products. In addition, the program will encourage students to feel confident in your own abilities to create a new product. Together with industrial experts, the program coordinator can assess the outcomes of these programs and the benefits to students. The long-term goal is to establish an interdisciplinary curriculum degree program at CSULB between engineering, industrial design and business administration. The question that arises and needs to be answered is: Would an interdisciplinary study degree between engineering, industrial design and business be a useful educational program with respect to post-graduation employment? Or is an interdisciplinary major seen as "jack of all trades, master of none" by the job market? We live in a world of specialization. But specialization does not mean an understanding of related disciplines is unimportant or unnecessary to the successful commercialization of an innovation.

## **Teaching Engineering Ethics: A Basic Strategy**

Marilyn Dyrud  
Oregon Institute of Technology

Since the “new” ABET criteria appeared over a decade ago, more engineering and technology programs have incorporated ethics components in response to Criterion 3f, that students display “an understanding of professional and ethical responsibility.” For new or even seasoned engineering educators, however, this is easier said than done. As one of the ancient fields of study, philosophy has developed a significant technical vocabulary over the span of 2,500 years, one that may intimate those new to the field. Terms like “categorical imperative,” “consequentialism,” and “deontology” are daunting not only to students but faculty as well. And the body of literature related to ethics is huge indeed, presenting a formidable challenge to those more accustomed to the language of engineering and technology. Given such a bewildering array of possibilities, what’s a busy professor to do? This paper will explore a basic strategy for introducing students to the field of engineering ethics, including resources for educators. Specifically, the paper will address the following:

- Acquainting students with professionalism
- Using professional codes
- Using cases
- Integrating appropriate ethical theory
- Suggesting potential assignments, both written and oral

## **New Potential in Presenting Research in the Engineering Literature: Opportunities for Scholarship and Instruction through Video**

Julia Gelfand and Anthony Lin  
University of California, Irvine/ Irvine Valley College

The nature of scientific communication has changed dramatically in the last decade. With the 1665 release of what are purported to be the first scientific journals with the French *Journal des Scavans* and the English *Philosophical Transactions of the Royal Society* competing to be the first publications dedicated entirely to science, a long tradition of science publishing follows. Since then, journal publishing has proliferated to present and document scientific findings. Engineering is the nexus of scientific, economic, social and practical knowledge that lends to the practice of designing, building, and maintaining structures, machines, devices, systems, materials and processes. Science publishing has assumed different roles within scholarly societies and across the commercial publishing spectrum each with different goals and objectives. Engineering journals have served the six central areas of the discipline by building on the physical sciences to focus on different aspects of each of the following areas: 1) civil & environmental engineering; 2) mechanical & aerospace/aeronautical engineering; 3) chemical & bio-chemical engineering; 4) electrical engineering & computer science; 5) industrial engineering; 6) biomedical engineering. Interdisciplinary links and connections suggest how new emerging fields have



evolved requiring their own journals as these fields continue to splinter with information intensity in new specializations. Much of engineering requires re-engineering to perfect and improve prior applications. The demands of new resources to support engineering instruction in increasingly distant learning environments demonstrate how new procedures and products are updated, incorporate multimedia in creative and mobile ways. Absorbing information is not only accomplished by reading texts, manipulating formulas and consulting images, but understanding is achieved by seeing, practicing and repeating as needed to fully grasp concepts. Two new product lines have recently been introduced to illustrate how multimedia has become central to new journals and will be demonstrated and described. The *Journal of Visualized Experiments* (JoVE) that began in 2006 with the life sciences as its central hub has now expanded into 8 new sections including Bioengineering (<http://www.jove.com/bioengineering>) and shows how this field's research multiplies. The second new information resource is the *Engineering Case Studies* issued by Alexander Street Press in early 2014. This is an online collection containing 250 hours of video and 50,000 pages of text to describe and study engineering failures. The international scope that each of these products offers the engineering community through videos that are primary source content enriches the teaching experience and provides a new generation of engineers a sense of earlier history and a visual method of learning. Best practices, including peer review, high citation values, utilizing the latest in video technologies, easily cited content make these resources a new direction in engineering education and scholarship. As the science, engineering, library and publishing communities and organizations continue to see many changes in the world of science communication and question whether the current rules and traditions of journals are optimal for collaboration, discovery, innovation, public policy and education, this presentation will examine how two new journal products continue to explore methods of communicating in relatively unique ways.

### **A Difficult Topic Made Easy: Developing A Straightforward Tuning Method for Acid Neutralization Control System**

Larry Jang and Roger Lo  
California State University, Long Beach

Acid (or base) neutralization is an important process in many industries, particularly in wastewater treatment plants and biotech processes. Most textbooks in chemical process control, however, do not cover this topic in details. The main reasons are due to the highly nonlinear nature of pH ( $= -\log([H^+])$ ) scale, variable pH titration curve, and existence of buffer species, etc. Many publications in this area use advanced approaches such as fuzzy or neural network logic, which may suit graduate-level research or curriculum, but they may be beyond the scope of the undergraduate curriculum. To better prepare our undergraduate students for this very important topic, the authors have developed a course module as well as laboratory experiments primarily based on standard tuning methods covered in the undergraduate curriculum by introducing the following changes: First, instead of pH, this work uses  $[H^+]$  as the controlled (or process) variable. Doing so immediately removes to a great extent some issues due to the highly nonlinear pH scale. Second, assume that weak acid (such as acetic acid, denoted as HA) is fed to a stirred-tank reactor and neutralized by another stream of strong acid (such as NaOH). Steady-state balance equations are established for “non-reactants” ( $HA$ ,  $A^-$  and  $Na^+$ ), which in turn allow one to calculate  $[H^+]$  in the reactor by introducing water product  $K_w$ , acid dissociation constant  $K_a$ ,

and equation of electrical neutrality. Third, by assuming the base flow rate to deviate somewhat from the original steady-state value, a dynamic model for the response of  $[H^+]$  can be derived. With this, we obtained the resultant first-order process gain and time constant for different steady states. Finally, tuning parameters  $K_c$  and  $t_i$  are established for various steady states with the internal model control (IMC) method. We then adopted one type of adaptive control strategy by building a schedule of tuning parameters around different steady states or operating conditions for a feedback control system. The simulated results show that nonlinear nature still exists. However, the extent of nonlinearity is much less, compared with that when pH scale is used. This new teaching module has the following advantages: (1) using  $[H^+]$  scale instead of pH greatly reduces the non-linearity of the math model involved, (2) using balance equations for “non-reactants” allows students to solve for steady-state conditions, and (3) by using well-established procedure, a dynamic model can be obtained and a schedule of tuning parameters for adaptive feedback control can be established.

### **Internet-Based System for Undergraduate Process Control Lab**

Larry Jang and Roger Lo  
California State University, Long Beach

Although process control is one core course in chemical engineering curriculum, many students feel that this course is a “different animal” due to the sophisticated mathematics involved, particularly the transient-state dynamic models. Some students even feel that this subject is just another mathematics course using Laplace transform in calculations and simulation. To bridge the gap between theories and practical applications, the authors have been engaged in converting or retrofitting existing unit operations in the department’s Unit Operations Laboratory with modern sensors, final control elements, and Internet infrastructure. We have designed a control algorithms using LabVIEW for the following unit operation experiments: (1) sour gas absorption column, (2) double-pipe heat exchanger, (3) distillation column, (4) flow, level, and temperature control station, (5) pH neutralization flow reactor, (6) flow in pipe, (7) color-fading batch reactor, (8) residence time in continuous stirred tanks, and (9) transient-state heat conduction in solids. Four different approaches have been developed that allow students to perform experiments remotely by (1) directly running the control algorithms from any computers in the department’s subnet; (2) using LabVIEW’s web publishing tool. In this approach, control algorithms are loaded on selected “server” computers with static IP addresses and names of the webpages assigned. Students may use a web browser from any computer to enter an appropriate webpage address (<http://IP.address.server.computer/webpage.html>) to take control of the server computer’s control algorithm; (3) using the FPGA approach in which the control algorithms are loaded onto the microprocessor chassis, which then implements self-regulated process control as programmed; (4) loading NI Data Dashboard App on an iPad or Android smart phone to remotely manipulate the control algorithms on the server computer. In this work, we present our system configurations and control algorithms. We also present sample results from student labs, students learning outcomes, and positive comments from the 2012 ABET visit. From the responses we have received so far, our students gain great interest in the modern tools, and their understanding of the subject matter has been significantly improved through this modernized equipment.

## **Integrative Method for Teaching Undergraduate Mechatronics Course by Combining Virtual and Hardware-in-the-Loop Simulations**

I-Hung Khoo and Panadda Marayong  
California State University, Long Beach

Mechatronic systems integrate the fields of mechanical engineering, electrical engineering, and computer controls and offer a wide range of engineering applications. Knowledge in mechatronic systems hence becomes a highly desirable skill required by industries for engineering students. This paper discusses an integrative method of combining system modeling, software simulation, and hardware-in-the-loop to teach undergraduate-level mechatronics to a combined class of mechanical and aerospace engineering (MAE) and electrical engineering (EE) students at California State University, Long Beach. In the existing curriculum, MAE students traditionally are not exposed to microcontroller and mechatronic system integration, whereas EE students have limited experience with modeling of mechanical and electromechanical systems. The cross-listed course combines the content on system modeling from mechanical engineering with the concepts of sensors and actuators as well as microcontroller control from electrical engineering to teach both groups of students using team-based lab activities. This integrative teaching method provides students with a variety of tools to model and control complex systems using virtual environment to actual hardware integration. The lab activities are designed to follow the important stages in the design cycle of a modern mechatronic system. They start with the initial virtual system modeling, followed by hardware in-the-loop simulation, and finally the full hardware implementation. The major benefit of the virtual environment simulation is that it allows students to easily manipulate the system component parameters and observe their responses, which is not possible in actual hardware implementation due to the complex interaction among the system components. This greatly enhances the students' understanding of the complex system. The next stage of the design cycle using hardware-in-the-loop simulation then allows students to control the virtual mechanical system using a physical microcontroller and troubleshoot their design before the final full hardware implementation. The task of tailoring the course contents to cater to both MAE and EE students is quite challenging. It is accomplished through this integrative teaching approach where students from different disciplines will equally benefit from the class. MAE students gain experience with microcontroller as well as sensor and actuator integration and control; while electrical engineering students are introduced to electromechanical and mechanical system modeling and analysis. Both groups of students acquire new skills that include hardware-in-the-loop simulation, testing, and hardware implementation through the use of MATLAB, Simulink, Simscape, and Arduino environments. By integrating hands-on mechanical and electrical engineering component as well as students from multiple disciplines, students are kept engaged with the course activities and benefit from working in an interdisciplinary environment.

## **Sustainability Systems Simulation for Engineers and Non-Engineers**

Samuel Perez  
Arizona State University

This is a proposed online systems dynamics modeling and simulation-learning lab for graduate students in a sustainability leadership program for engineers and non-engineers at Arizona State University. This learning lab is fully online and uses active learning principles wherein students learn by doing and apply theory into real world application. A simulation and modeling program called insightmaker.com provides a web-based graphic user interface to add primitives such as stock and variables and make connections using link and flow elements. A simulation run shows the defined stock against a timeline on a dynamic graph. This simulation is free to use for the student. Students will create solutions for sustainability issues with climate change, urban cities and supply chain management. Their task is to weave a narrative story behind their proposed solution to allow stakeholders, executive champions, constituents and communities to see the value of their solution from the point of view of the end-user. This simulation allows students to perform a proof of concept for a sustainable solution. As a proof of concept, this modeling and simulation set of tasks provides a foundation to pilot a proposed solution on a larger and complex scale. Students can demonstrate, make predictions of system performance and offer strategies and solutions for optimization. This lab allows students to visualize and measure risk in a proposed strategy without interrupting mission critical processes of a production or a client's business. Various "what if" scenarios can be devised and a simulation run on that new value or parameter in an efficient and timely manner. The culminating assessment activity of this lab will be the creation of a TED Style presentation and showcase the student's sustainability solution using a systems dynamics modeling technique. A strong emphasis on creating a compelling story for the presentation is required.

### **IEEE Xplore: What's In It for You?**

George Plosker  
IEEE, Client Services Manager

Virtually all academic engineering programs have access to the IEEE Xplore Digital Library, providing full text access to more than 3.5 million IEEE documents. The IEEE Xplore Digital Library represents approximately 1/3 of the world's engineering literature, including significant expansion of interdisciplinary content and Open Access publishing options. This collection includes IEEE (and IET) peer-reviewed journals, conference papers, Standards, and eBooks. Learn how to use IEEE Xplore in a "best practices" manner; including creative uses such as embedding readings in curriculum, job related research, citation analysis, and "push" alerting capabilities. Learn how to:

- Review the technical literature effectively by constructing successful search strategies for precise results
- Share IEEE content to promote collaboration and knowledge sharing

- Locate information created by universities, companies or organizations using author affiliation
- Stay current by setting-up personalization in IEEE Xplore to use alerts and saved searches
- Find best papers by using "Sort by Most Cited"
- Plus, learn what IEEE Xplore can do that Google can't!

### **Culturally Relevant Pedagogy in Science and Engineering: Theory into Practice**

Lily Gossage and Rose Pringle

California State Polytechnic University, Pomona/ University of Florida, Gainesville

Science educators have noted that while science and engineering are important to United States maintaining its global competitiveness, access to a high-quality education remains determined by one's status such as socioeconomic class, racial or ethnic group, gender, language background, disability designation, or national origin (Quinn, Schweingruber, & Keller, 2012). Furthermore, despite an increase in the number of Americans attaining college degrees, the percentage of underrepresentation of ethnic minorities in science and engineering still remains high. The causes and consequences of such underrepresentation in STEM have generated considerable debates and numerous initiatives aimed at altering such occurrences. In K-12 learning environments however, some measures of success have been achieved as seen in recently concluded national and international assessments. For example, the recent report of the 2011 National Assessment of Educational Progress (NAEP) science assessment indicates a narrowing of achievement gaps between white and Black students and between White and Hispanic students from 2009 – 2011. As global competition for science and engineering talent intensifies, there is an urgent call for attention to be paid to increasing the participation and success of underrepresented minorities and female students enrolled in STEM courses in the universities (Chatman, Nielsen, Strauss, Tanner, & Atkin, 2008). In this workshop, we will introduce culturally relevant pedagogy as a potential strategy for effectively teaching traditionally underrepresented minority college students who pursue STEM majors. Participants will be engaged in a robust dialogue and relevant activities, and we will raise the question: How can pedagogical practices in the university support the academic success of *all* learners and in the process increase participation of underrepresented minorities and women in STEM? The activities in this workshop are being offered to introduce an educational practice embraced in K-12 learning environment (Ladson-Billings, 1995; Nguyen, Terlouw, & Pilot, 2006; Richards, Brown, & Ford, 2007), but has never received the same level of patronage nor understood as a conceptual framework by faculty in institution of higher education. Culturally relevant pedagogy is designed to “problematize teaching and encourage [faculty] to ask about the nature of their student-teacher relationship, the curriculum, schooling, and society” (Ladson-Billings, 1995, p. 483). We will present strategies that a) can be easily adapted into science and engineering courses, and b) support the design and implementation of practices that are culturally relevant and have the potential to transform the critical instances of meaningful teaching and learning in STEM. These include alternative conceptualizations of critical practices such as approach to coursework, pedagogy, nature of student-teacher relationship, beliefs and expectations of all learners and stereotype.

## **Hands-on Gadgets to Facilitate Algorithmic Thinking and Problem Solving**

S. R. Subramanya  
National University

Computers are used for solving numerous problems, to obtain optimal solutions (wherever possible/practical/feasible), in various domains such as engineering, sciences, healthcare, transportation, urban planning, banking and finance, retail/commerce, etc. In the increasingly technology driven world, it is essential for students in science, engineering, and management to have the capabilities of critical thinking, problem analysis, and problem solving to develop algorithmic solutions to numerous real-world and societal problems. In this workshop, we present a variety of gadgets which have been specifically designed for several classes of problems, and their solutions which are based on well-known algorithm design techniques. The participants will be working in groups, actively engaged in using the gadgets to arrive at the solutions to the problems. The hands-on technique facilitates (a) concretization of abstract problem statements; (b) better understanding of the problem; (c) exploration of the solution space; (d) development of optimal solution. The expected workshop outcomes are: (a) good analytical, problem-solving, and critical thinking skills; (b) understanding of algorithm design techniques; (c) ability to apply algorithms for systematic solution development; (d) ability to evaluate the solutions for correctness and efficiency; (e) experience in working as part of a group; (f) fun.

## **Beyond the Basics: Transforming Engineering Education**

Deborah Won, Lizbeth Schlemmer, Linda Vanasupa, Gustavo Menezes, Arturo Pacheco-Vega,  
Tonatiuh Rodriguez-Nikl, Adel Sharif, and Crist Khachikian  
California State University, Los Angeles/  
California Polytechnic State University, San Luis Obispo/  
California State University Northridge

The aim of this workshop is to discuss with each other how innovative teaching strategies that have been widely used and proven successful (e.g.: service learning, project-based, learn by doing, deeper-learning) can be used to transform engineering curriculum to educate engineers of the future. During the workshop the experiences of two NSF funded programs, SUCCEED (DUE 1246130) and SUSTAIN SLO (EEC 0836037, DUE 1044430, DUE 1256226), at CSULA and CalPoly SLO, respectively, will be discussed. The Sophomore Unified Core Curriculum in Engineering Education (SUCCEED) is merging sophomore-level courses into interactive, workshop-style courses and designed to thereby transform the student learning experience into an engaging student-centered one that promotes deeper learning. The traditional pedagogical format (lecture, assign homework, and return graded homework) will be replaced by a series of laboratory courses and clinics that provide the students with ample practice working through engineering problems collaboratively with faculty, teaching assistants, and peers. The curriculum design is driven by outcomes established to help Engineering majors acquire a strong

foundation in core competencies in 1) analysis, 2) applications, 3) design and modeling, 4) communication, and 5) professionalism. SUSTAIN-SLO is a university wide freshman learning initiative formed by the collaboration between faculty, community partners and students. Its intent is to learn together by designing and implementing sustainability related projects in SLO County that contribute to a thriving community. Panelists will also discuss with participants strategies that can be used to overcome the challenges faced by engineering education innovators during development and implementation of such programs. We hope to learn together how to support and encourage innovative practices that serve students and faculty alike.

**MESA WORKS: Inspiring Young Minds to Become Future Mathematicians, Engineers and Scientists by Incorporating Common Core State Standards**

Saba Yohannes-Reda  
California State University, Long Beach

MESA (mathematics, engineering, science, and achievement) is nationally recognized for its innovative and effective academic development program. For over 40 years, MESA has been producing math-based graduates by providing support such as classes, hands-on competitions, counseling, transfer support and a community environment to students from middle school through four-year college. MESA engages thousands of educationally disadvantaged students so they excel in math and science and graduate college with math-based degrees. MESA serves students in pre-college through the MESA schools program (MSP), community college students through the MESA community college program (MCCP), and four-year college level students in the MESA engineering program (MEP). Most MSP Centers, like CSULB, are housed at four year universities and within the college of engineering. The MSP program partners with school district administrators, teachers, parents and industry representatives to provide academic enrichment activities. CSULB's MSP program is a year-long program that introduces middle and high school students to STEM (Science, Technology, Engineering, and Math) fields using hands-on math and science MESA Day projects. In addition, MESA students involved in the program have an opportunity to be mentored by undergraduate engineering students from CSULB. The focus of this workshop is the MSP program at California State University, Long Beach, which was established in the 1980s and currently serves over 1,000 students in partnership with five school districts, twenty-three middle schools, twelve high schools and fifty math/science teachers annually. The workshop will also inform participants about the benefits of this long term collaboration with school districts and the strategies teachers use to implement Common Core State Standards using MESA Day projects. Educational Standards describes what students should know and be able to do in each subject in each grade. In California, the State Board of Education decides on the standards for all students, from kindergarten through high school. Since 2010, forty-five states have adopted the same standards for English and math. These standards are called the Common Core State Standards (CCSS).

## AUTHOR INDEX

Adle, M.	11	Colacio, A.	525	Grubbs, E.	240
Aguilar, D.	525	Dababo, N.	91, 522	Halstead, S.	519
Aliyazicioglu, Z.	17, 528	Davidian, A.	194	Hamabata, J.	154
Allen, E.	413	Davis, A.	422	Hanson, T.	525
Alvarez, D.	333, 534	DePalma, J.	118, 486	Harney, R.	526
Amin, M.	24, 340, 508	Derakhshan, S.	522	Haungs, M.	382
Amir, M.	531	Dey, P.	24, 340, 508	Hawley, H.	526
Anagnos, T.	413	DiFiori, R.	530	Hipolito, S.	11
Anderson, K.	519	Dillon, D.	118	Ho, C.	363
Argin, M.	519	Dillon, J.	540	Hoffman, K.	537
Armstrong, T.	533	Ding, Y.	528	Holtzman, M.	526
Arnold, B.	32	Dong, J.	539	Hovik, W.	527
Asgari, S.	44	Duncan, D.	526	Htun, C.	333, 534
Ashworth, J.	53	Dunn, C.	521	Huang, Z.	520
Asvapathanagul, P.	520	Dyrud, M.	544	Irvine, P.	294
Ayon-Serrato, F.	521	Elder, E.	268	Jaikumar, P.	321
Bai, K.	91	Englert, B.	44	Jaksic, N.	118, 159, 486
Balagtas, M.	521	Enright, J.	333, 534	Jang, L.	545, 546
Baxter, T.	363	Enriquez, A.	91, 333, 422, 531	Jiang, H.	91, 333, 531
Berg, K.	519	Ettegui, N.	531	Johnston, H.	173
Beverly, S.	61	Farahani, A.	456	Kang, E.	471
Beyer, C.	543	Farahmand, F.	529	Karim, R.	519
Bhandari, S.	528	Figuerola, R.	91, 522	Khachikian, C.	550
Bingham, R.	268	Fletcher, H.	543	Khoo, I.	547
Bohlin, C.	399, 537	Flores, Jasmine	333, 534	Kim, J.	166
Bohn, K.	69	Flores, Jina	533	Kingsford, L.	540
Booth-Caro, E.	533	Franco, N.	525	Korman, T.	173
Boskovich, S.	528	Galvez, G.	140, 532	Kotys-Schwartz, D.	228
Bostwick, J.	11	Gan, Y.	11	Koushkebaghi, A.	531
Bowen, D.	24, 508	García, J.	524	Kredo II, K.	182
Brady, M.	399, 537	Gardner, M.	326	Kuo, J.	17
Brazier, C.	522	Garibay, J.	194	Kwon, O.	471
Brueseke, B.	81	Gatdula, N.	532	La, K.	528
Buell, M.	91, 522	Gedalanga, P.	520	Lamer, M.	363
Callahan, J.	523	Geldiyev, S.	519	Landsberger, S.	194, 528
Cardenas, M.	96	Gelfand, J.	544	Larson, D.	214
Celik, O.	524	Georgette, J.	69	Lauff, C.	228
Cervania, K.	525	Ghazaryan, S.	443	Lazos, L.	240
Chandra, R.	17	Gore, K.	173	Lee, M.	529
Chang, J.	540	Gossage, L.	524, 539, 549	Lewis, C.	524
Chen, C.	91, 333, 350, 422, 531, 534	Graves, K.	11	Liguori, E.	500
Cherngchaosil, R.	521	Gregory, G.	528	Lin, A.	544
Clague, D.	108	Gregory, S.	525		



Lo, R.	545 546	Plosker, G.	548	Tajvidi, M.	388
Longhurst, G.	268	Pong, W.	91, 333, 422, 531	Tang, D.	528
Lopez-Casildo, Jr., F.	524	Prado-Guerrero, H.	531	Taufik, T.	309, 314
Macedo, J.	247	Pringle, R.	549	Taylor, T.	523
Mahmoodi, H.	91, 333, 531	Pullen, J.	520	Teh, K	91
Maldonado, H.	492	Quinn, W.	53	Tehrani, F.	255, 399, 500,
Marayong, P.	539, 547	Quintana, P.	465	Telford, A.	108
Marinez, E.	140	Radimsky, A.	529	Teubner, D.	543
Martin, J.	443	Raeisi, R.	326	Tingerthal, J.	363
Martinez, S.	492	Ramirez, M.	532	Trabolsi, T.	166
McComb, C.	255	Rangel, R.	326	Tran, D.	465
McCrigler, B.	289	Rascon, M.	532	Tuberty, J.	413
McNamara, C.	519	Reeves, R.	32	Uludag, A.	519
Melgar, R.	531	Regier, J.	537	Valdovinos, J.	422
Menezes, G.	550	Rentsch, N.	524	Valenzuela, F.	194
Mezyk, S.	522	Rentschler, M.	228	Vanasupa, L.	550
Moala, P.	91, 522	Rezaei, A.	532	Vargas, V.	524
Moll, A.	523	Rios-Ellis, B.	532	Vergara, C.	538
Monge, A.	140	Robles, A.	333, 534	Viana, J.	538
Monteroso, F.	519	Rodriguez-Nikl, T.	550	Villalta, R.	528
Murphy-Hayden, P.	533	Rojas, O.	521	Vu, K.	539
Murray, J.	268	Romney, G.	24, 81, 340, 508	Wallace, T.	520
Naish, D.	283	Rosenkrantz, P.	534	Wang, L.	429
Nelson, F.	399, 537	Ruiz, J.	535	Warter-Perez, N.	443, 539
Nelson, P.	17	Sablan, A.	525	Weilder-Lewis, J.	228
Nelson, S.	289	Sakurai, C.	521	Wheeler, B.	194
Noravian, A.	294	Sanchez, F.	350	Widmann, J.	69, 535
Nguyen, T.	500	Saoud, B.	535	Wilbur, J.	108
O'Connor, K.	228	Sarper, H.	118	Won, D.	550
Olson, B.	520	Schlemer, L.	550	Word, D.	182
Olson, L.	523	Self, B.	69, 535	Wyne, M.	456
Osorno, B.	305	Shahnasser, H.	91, 333, 531	Yeh, H.	465
Ou, J.	529	Sharbat, A.	530	Yohannes-Reda, S.	551
Pacheco-Vega, A.	550	Sharif, A.	550	Yoon, I.	471
Pal, F.	538	Singh, S.	359	Young, K.	540
Palomo, M.	530	Sinha, B.	24, 340, 508	Yuan, D.	486
Papavasiliou, N.	399, 537	Slowinski, K.	522	Zhang, C.	529
Parada, N.	528	Smaglik, E.	363	Zhou, Z.	540
Parastiwi, A.	309, 314	Smilkstein, T.	374	Zoghi, M.	492, 500
Paudel, A.	531	Staley, C.	382	Zoghi, S.	500
Pecjinovic, B.	526	Stasiowski, E.	108		
Penny, D.	268	Strybel, T.	539		
Perez, S.	548	Subramanya, S.	535, 550		
Peterson, M.	321	Sujanani, S.	17		
Pham, T.	519	Sultana, R.	536		
Pickett, G.	321	Sweeney, N.	247		
Piroozan, P.	532				